

Palladium Books® Presents:

Rifts® World Book Nine:

South America: 2™

By C.J. Carella



Warning!

Violence and the Supernatural

The fictional World of Rifts® is violent, deadly and filled with supernatural monsters. Other dimensional beings, often referred to as “demons,” torment, stalk and prey on humans. Other alien life forms, monsters, gods and demigod, as well as magic, insanity, and war are all elements in this book.

Some parents may find the violence and supernatural elements of the game inappropriate for young readers/players. We suggest parental discretion.

Please note that none of us at Palladium Books® condone or encourage the occult, the practice of magic, the use of drugs, or violence.



A supplement for the Rifts® RPG.
Compatible with the entire Palladium Books® Megaverse®!

Rifts® World Book Nine

South America 2



Written By: **Carlos J. Martijena-Carella**

Additional Text & Concepts: **Kevin Siembieda**

Senior Editor: **Kevin Siembieda**

Editors: **Alex Marciniszyn**

James-A. Osten

Kevin Kirsten

Julius Rosenstein

Cover Painting: **Kevin Long**

Interior Artists:

Vince Martin

Wayne Breaux

R.K. Post

Kevin Siembieda

Art Direction & Keylining: **Kevin Siembieda**

Typography: **Maryann Siembieda**

Special Thanks to C.J. for belting out another epic Rifts® book! To “blurry-eyed” Vince for jumping immediately from Rifts Japan into South America 2 without a break (great stuff too). Randy Post for more dark and intricate artwork. To Wayne “I’m a machine, give me more, I can make that deadline” Breaux. Jim “not more editing already” Osten, Kevin “I’ll do whatever it takes” Kirsten, “late night” Alex and Maryann, Julius and the usual Palladium wizards.

Kevin Siembieda

Contents

Introduction	8
The Empire of the Sun	9
The Lost Nazca Civilization	9
The History of the Old Inca Empire	10
The Return of the Gods	12
The Arkhons	13
Cities and Places of Note	17
O.C.C.s and R.C.C.s of the Empire	20
True Inca R.C.C. Demigods	20
Inca Warrior O.C.C.	23
Inca Sun-Priest O.C.C.	24
Nazca Line Maker O.C.C.	26
Rune Warrior O.C.C.	28
Nazcan Line Magic	30
Common Line Drawings	31
Close Rifts	31
Draught of Health	31
Feast Sign	32
Lesser Animal Drawing	32
Greater Animal Drawing	34
Monster Drawing	34
Earthquake Pattern	34
Energy Jar	35
Entryway	35
Fire lines	35
Healing Pattern (Minor)	35
Line Blast	35
Pattern Armor	35
Pattern of Control	36
Pattern Wall	36
Pattern of Wounding	36
Power Symbol	36
Symbol of Pain	36
Wield Lightning	36
Secret Line Drawings	37
Create Ley Line Storm	37
Extend Ley Line	37
Make Ley Line	37
Open Rift	37
Permanency	38
Warrior Pattern	38
The Secrets of the Nazca Lines	38
Hummingbirds	39
Wizard	39
Monkey	39
Spider	40
Tree of Life	40
Energy Line System	40
The Pantheon of the Sun	40
Viracocha, the All-Father	40
Inti, the Sun God	42
Pachamama, the All-Mother	43
Illapa, God of Thunder & Storm	45
Manco Capac, The First Inca	46
The Heroes of the Sun: Manco Capac's Chosen	47
Forces of Darkness	48
The Ancient R.C.C. Incan Undead	48
Yahuar Huacac, the Blood Weeper	50
The Pucara, the Red Giants	52
Pucara Red Giant R.C.C.	54
Pucara Mind Mage O.C.C.	55
Weapons and Equipment of the Empire	56
Inti-10 Variable Laser Pistol	56
Inti-20 Variable Laser Rifle	57
Illapa-1 Rocket Pistol	57
Illapa-5 Rocket Rifle	57
Gilded Body Armor	58
Sinchi Body Armor	58
Nazca Power Armor	59
Armor of the Sun	61
Atahualpa Combat Suit	63
Solar Combat Armor	64
Slinger light Tank	66
The Arkhons	67
In Orbit	68
In South America	68
The Arkhon Freehold	69
Overlord Enno	70
Arkhon R.C.C.	71
Arkhon Spectral Hunter O.C.C.	73
Arkhon ESP Specialist O.C.C.	75
Fallam R.C.C.	76
Fallam Battlemaster O.C.C.	77
Arkhon Weapons & Equipment	79
E-clips	79
TB-3 Tri-Beam Energy Pistol	80
TB-9 Auto-Pistol	80
TB-Prime Tri-Beam Energy Rifle	80
M-100 Tri-Beam Crew Served Gun	81
BM-2 Backpack Mortar System	81
BRL-3 Backpack Rocker Launcher	82
Tri-Blade Energy Sword	82
FR-5 Flechette Rifle	83
FRA-1 Flechette Auto-Cannon	83
Robots & Power Armor	83
Arkhon Body Armor	83
Stormwind Assault Exoskeleton	84
Ghost Wasp Aerial Power Armor	86
Death Cyclops Assault Suit	88
Great Cyclops Assault Robot	91
Other Vehicles	93
"Porcupine" T-10 Assault Tank	93
"Evil Eye" APC	95
Spikefist Attack Fighter	96
The Megaversal Legion	98
The Dakir Race	100
City Notes	103

Common R.C.C.s & O.C.C.s	104
Megaversal Trooper (Human) O.C.C.....	104
Megaversal Trooper O.C.C./Ojahee R.C.C.....	106
Destroyer 'Borg O.C.C.....	107
Ojahee Cyborg O.C.C.....	109
Men-Rall "Tech Master" R.C.C.....	111
Weapons & Equipment of the Legion	113
IAR-20 Inertia Rifle.....	113
IAR-2 Auto-Pistol.....	114
HIAR-22 Heavy I-Beam Rifle.....	114
ARP-1 Plasma Assault Rifle	114
HRP-1 Plasma Heavey Rifle	115
H-11A Howitzer	115
Armor & Power Armor	115
Mark I Body Armor.....	115
Mark II Body Armor.....	115
Counterstrike Power Armor	115
Vehicles	117
Neo-Abrams M10A1 Main Battle Tank.....	117
Neo-Bradley M6IFV Scout Vehicle.....	119
Neo-Apache AH-50 Attack Aerodyne	120
The Silver River Republics	122
Cordoba.....	122
Santiago.....	126
Common O.C.C.s	127
Gaucho O.C.C.....	128
Plains 'Borg O.C.C.....	129
Ultra-Crazy O.C.C.....	131
Blood Rider O.C.C.....	133
Master Blood Rider O.C.C.....	135
Blood Lizard R.C.C.....	137
The Achilles Republic	138
R.C.C.s & O.C.C.s	141
Serpentoid R.C.C.....	141
Mutant Capybara R.C.C.....	142
Equinoid R.C.C.....	144
Condoroid R.C.C.....	146
Falconoid R.C.C.....	148
Achilles Neo-Human R.C.C.....	149
New Babylon	152
Amaki Stone-Man R.C.C.....	154
Duelist R.C.C.....	155
Gizmoteer R.C.C.....	157
Other Republics	159
The Southern Federation	159
The Shining Path.....	160
Italo Industries	161
Nuevo Peru (New Peru).....	161
The Local Caudillos.....	162
The South American Devil's Triangle	162
Languages	162
Weapons	163
NP-10 Plasma Net Launcher	163
IP-7 Ion Pistol	163

I-9 Heavy Ion Rifle.....	163
I-11 Long Gun	164
Equalizer Combat Shotgun.....	164
Lightbringer Laser Rifle	165
Amaki Blast-Sword	165
Amaki Blast Rifle	165
Amaki TW Psi-Blade.....	165
ATL-7 Anti-Tank Laser Rifle	166
Body Armor	166
Customizagle Armor (Achilles)	168
Power Armor	168
Mecha-Lizard Power Armor.....	168
Toro "Minotaur" Power Armor.....	171
Glitter Boy Number 7.....	173
Mastodon Battle Robot.....	175
Galapagos Submersible Robot	177
Puma-Class Medium Battle Tank.....	180
Hussar APC.....	182
The Larhold Barbarians	183
Larhold Barbarian R.C.C.....	185
Larhold Human Renegade O.C.C.	186
War Bison	187
Larhold Shaman O.C.C.	188
Blue Flame Spells	190
Experience Tables	192

Quick Find Table

Ancients.....	16 & 48
Ancients: Blood Weeper	50
Ancients: City of the Dead.....	19
Blue Flame Magic	190
Empire of the Sun (Inca & Nazca).....	9
Inca: Empire of the Sun.....	9
Inca: Members of Empire of the Sun.....	9
Inca Gods: Pantheon of the Sun.....	40
Inca Undead: Ancient R.C.C.	48
Larhold War Bison.....	187
Psyscape (New Babylon)	154
Mutant Animals: Members of Achilles	138
Nazca: Empire of the Sun	9
Nazca Lines & How to Use Them	38
Nazca Line Magic	30
Arkmons	67
Arkmon: Cerasteel.....	79
Arkmon: Death Cyclops.....	88
Arkmon: E-Clips	79
Arkmon Freehold	69
Arkmon: Ghost Wasp.....	86

Arkhn: Great Cyclops	91
Arkhnons in Orbit	68
Arkhn Overlord Enno.....	70
Arkhn: Spikefish Attack Fighter	96
Arkhn R.C.C.....	71
Arkhn: Tri-Blade Energy Sword.....	82

Maps

Empire of the Sun.....	15
Megaversal Legion.....	98
Silver River Republic.....	122
Shining Path (Terrorists).....	160
South America (Overview).....	7

O.C.C.s & R.C.C.s

Amaki: Duelist R.C.C.	155
Amaki: Gizmoteer R.C.C.....	157
Amaki Stone-Man R.C.C.....	154
Ancient R.C.C.	48
Arkhn R.C.C.....	71
Arkhn ESP Specialist O.C.C.....	75
Arkhn Spectral Hunter O.C.C.....	73
Blood Lizard R.C.C.....	137
Blood Rider O.C.C.....	133
Blood Rider: Master R.C.C.....	135
Experience Tables	192
Fallam R.C.C.....	76
Fallam Battlemaster O.C.C.....	77
Gaicho O.C.C.	128
Inca Sun Priest O.C.C.	24
Inca/Nazca Rune Warrior O.C.C.....	28
Inca Warrior O.C.C.....	23
Larhold Barbarian O.C.C.....	185
Larhold Human Renegade O.C.C.....	186
Larhold Shaman O.C.C.....	188
Megaversal Legion: Destroyer 'Borg O.C.C.....	107
Megaversal Legion: Men-Rall R.C.C.....	111
Megaversal Legion: Ojahee Cyborg O.C.C.....	109
Megaversal Legion: Human Trooper O.C.C.....	104
Megaversal Legion: Ojahee Trooper R.C.C.....	106
Mutant: Capybara R.C.C.....	142
Mutants: Condoroid R.C.C.	146
Mutant: Equinoid/Psi-Taur R.C.C.....	144
Mutant: Falconoid R.C.C.....	148
Mutant: Neo-human R.C.C.....	149
Mutant: Serpentoid R.C.C.....	141

Nazca Line Maker O.C.C.....	26
Plains 'Borg.....	129
Pucara, The Red Giants R.C.C.....	54
Pucara: Mind Mage O.C.C.....	55
True Inca (Demigod) R.C.C.....	20
Ultra-Crazy (TW).....	131

Megaversal Legion98

Megaversal Legion: Troop Numbers.....	103
Megaversal Legion: Common R.C.C.s/O.C.C.s.....	104
Megaversal Legion: Inertia Weapons.....	113
Megaversal Legion: Vehicles	117

Weapons & Items of Note

Armor of the Sun.....	61
Blast Rifle (Amaki).....	165
Blast Sword (Amaki)	165
Cerasteel (Arkhn).....	79
Glitter Boy #7.....	173
Inertia Weapons	113
Inti-10 Variable Laser Pistol.....	56
Mecha-Lizard	168
Solar Combat Armor.....	64

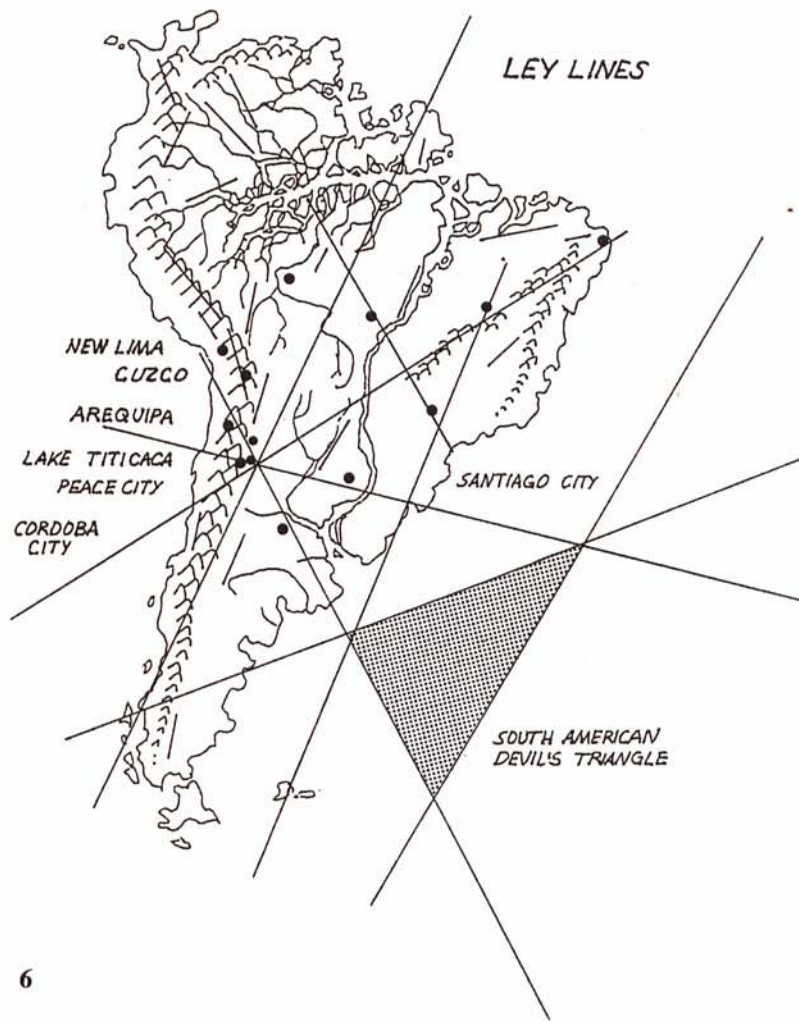

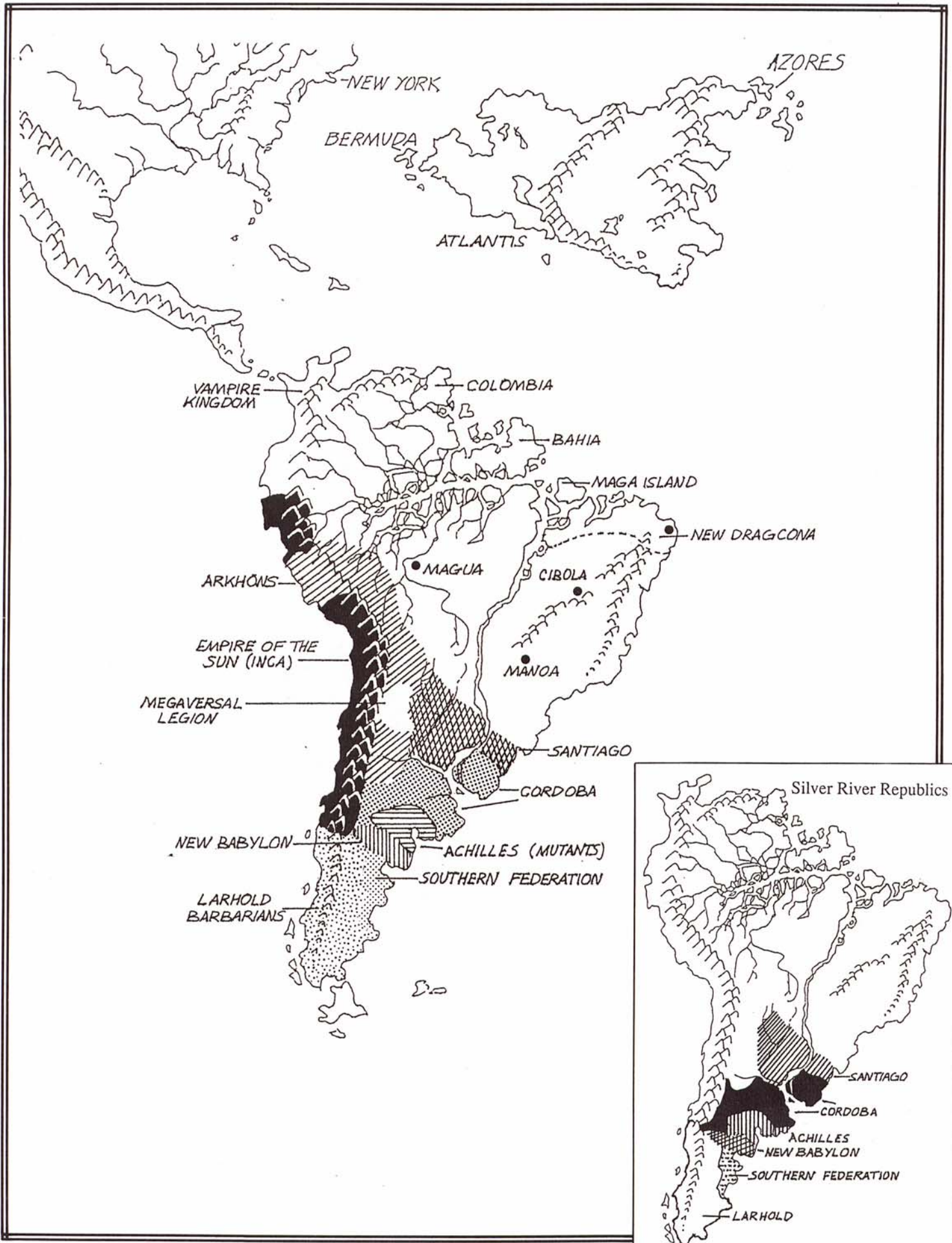

Introduction

This book marks two special moments for me. First of all it completes (well, almost completes) my foray into the South America of Rifts Earth, where myths from the past and wonders from impossible futures stand side by side. This exploration has been particularly exhilarating. Secondly, this is the first book completed since my move to Michigan, and my full-time commitment to Palladium Books. This move marks the conclusion of a five-year process between being a gaming fan and becoming a full member of the gaming industry. I hope this book is but the harbinger of things to come.

Rifts® South America Two continues to explore the continent. Here you will find the reborn Inca Empire battling extraterrestrial invaders, uncover the secrets of the Nazca lines, and explore the Silver River Republics, where humans, mutant animals and D-Bees live, build wondrous machines, and face all kinds of dangers. I was perhaps too ambitious, and some sections of the book had to be left out, including an adventure dealing with the fate of Professor Cudbury (from *South America: One*). Perhaps a future supplement will both expand on existing material and add new storylines.

The next several **Rifts®** books will focus on the “roots” of the *Rifts RPG* — North America. Kevin and I will be working on a number of exiting projects, including the **Juicer Uprising™**, **Psyscape™**, the **New West**, **Lone Star**, **The Coalition** and **Chi-Town** books, among other projects. I know that 1996 is going to be a tremendous year for Rifts, and firmly believe you won't be disappointed. Enjoy!

— C.J. Carella



The Empire of the Sun

The region occupying much of pre-Rifts Peru and Bolivia is a cauldron of magic and conflict, a place of heroes, demigods and technology. Like mythical Atlantis, the court of Camelot and the fabulous cities of El Dorado, the new Inca Empire is a throw-back to an older era, returning in these times of magic to regain its lost glories. It is a place where magic and the surviving remnants of technology have combined to create a unique culture. However, the Empire of the Sun faces an alien threat that may endanger the entire planet.

Shadows of the Past

Archaeologists and historians from before the Rifts could only guess about the enigmatic civilizations of the Andes mountains. The Incas were relative latecomers to the Peru-Bolivia region. Many other cultures, some of them dating back as far as 10,000 BC, had settled in the region. Among them was the fabulous **Nazca Empire**, which rose and fell before recorded history began. Nearly nothing is known about the True Nazcans, and very little is known about those who followed them through history. These civilizations, including the Moche, the Wari, and the Nazca, have become all but extinct, with a few legends and fragmentary languages as their only legacy.

One of the most powerful civilizations in the Andes before the rise of the Incas, was the **Chimu Nation**. The Chimu built stone pyramids and lived in fortified cities. It is possible that some of their culture and knowledge came from Atlantean refugees from the ancient cataclysm that destroyed that civilization. According to Chimu legends, the founders of their great cities arrived on the coast on makeshift rafts, and are said to be the survivors from the great floods that followed the destruction of Atlantis. The legends indeed had a grain of truth in them. The Chimu were influenced by the Atlanteans, and part of that legacy would survive the millennia.

The Lost Nazca Civilization

Although pre-Rifts archaeologists did not know this, the Nazca civilization was the oldest in the area. Other cultures rose and fell in the centuries that followed.

Little is known of the Nazca civilization. It was apparently an ancient culture, best known for their intricate ceramics, pottery and the fabulous Nazca Lines (giant symbolic animals and shapes etched into the desert sand). The Nazca were believed to have developed their culture between 1 and 600 AD, and which declined shortly thereafter, but the Nazca actually existed over ten thousand years earlier. This fact has escaped historians because even before the Rifts, there were very few archeological remains of this civilization, and no records besides the desert drawings, legends and myths of the indigenous people.

The unknown truth is that the Nazcans had built an ancient civilization of unimaginable age and power, older than any archeologist could envision. Around 10,000 B.C., the Nazcans built a large and powerful kingdom, controlled by magicians. This was the same era in which *Atlantis* and *Lemuria* flourished, and only the fabulous civilizations of Atlantis and Lemuria could match the power of Nazca. The three cultures grew during the same prehistoric era, from which no recognizable records survived.

The Nazcans' mastery over **Line Magic** allowed them to create huge palaces and buildings of pure magical energy! Unlike Atlantis and Lemuria, who built enormous towers and pyramids of stone and metal, the Nazcan cities used no physical materials, and yet they were just as large and powerful. Using their power over symbols, the mage-kings of Nazca grew in power and traveled to other worlds by opening Rifts in reality. By drawing on the ground and performing complex ceremonies, the Nazcans were able to greatly increase the power of ley lines. Drawings on ceramic pots were used to transform magical energies into food and mystical potions. They even drew magical symbols on human skin, granting powers similar to those conferred by **Tattoo Magic** (described in *Rifts Atlantis*). For the most part, they used their mystic secrets for peaceful purposes — bringing rain down over their arid mountain lands, protecting the people from earthquakes and natural disasters, and healing the sick.

The Great Disaster was brought about by Atlantis' tampering with transdimensional magicks. As a result, the magical energy levels of the world were nearly depleted. To the Nazca civilization, this was utter catastrophe. Their buildings suddenly ceased to exist, causing thousands to fall to their deaths as the walls and floors of their towers became insubstantial. The carefully created energy matrix that kept their cities strong, collapsed. Transdimensional gates slammed shut, trapping thousands of Nazcans on hostile alien worlds. The most powerful of their sorcerers escaped Earth through the last dimensional Rifts, but wouldn't return for thousands of years. As the magic energy of the planet waned, the Nazca civilization decayed and all but disappeared. Their culture and very existence becoming a thing of legend to the primitive tribes that lived around them. Only a tiny remnant, led by a handful of line makers, survived. They kept alive the Nazca culture that would be discovered by modern archaeologists thousands of years later. However, this community was a considerably younger and much inferior civilization, best known for its colorful pottery and the mysterious line drawings of the Nazca Plateau.

Alien Invasion & the Nazca Lines

With the disappearance of mystic energy, the Nazca became just one more tribe living in the mountains. The *line makers* among them used their powers sparingly, and kept their knowledge alive through the centuries by teaching the line drawing secrets to worthy pupils. Life went on.

All this changed with the coming of the *Arkhons*, sometime in 100 BC. The Arkhons were aliens from another galaxy, explorers and conquerors with little sympathy or mercy for the more primitive races. A huge, miles-long mothership appeared high over the Earth's sky. Many legends of sky chariots, portents and other "lights in the sky" myths were inspired by this awesome sight. The conquest of Earth appeared to be inevitable.

The arrival of the strangers had not come without forewarning, however. Several old Nazcan seers and prophets, the heirs of the ancient lost civilization, sensed the danger facing the planet. Unlike other gifted men and women in other nations, the Nazcan seers were heard and their warnings heeded. At the same time, many of the magicians who had abandoned Earth centuries before returned to help their descendants one more time. A year before the alien ship arrived, the Nazcans started building a set of magic lines larger and more powerful than anything created since the collapse of the ancient, true Nazca culture. Motivated by desperation, the Nazcans ruthlessly drew as much mystical energy from the Earth as they could to fuel their powerful spells. Lines of giant animals were drawn, covering an area of over five miles, which drew on the power of a dozen major ley lines and four nexus points. As chance or fate would have it, the arrival of the Arkhons occurred only a few days before the summer solstice, giving the Nazcans more power for their ceremony; it proved to be barely enough.

As the Arkhons prepared their invasion plans, the Nazcans performed a massive group ritual, involving over two hundred magicians, shamans and priests. The lines they had drawn on the ground shone with blinding light, and the animals they had designed suddenly came to life as giant energy beings that flew into the sky to meet the invaders. At the same time, blasts of pure psychic energy emerged from the geometric patterns, smashing into the Arkhons' mothership.

The Arkhons had no knowledge of magic. Unprepared for the mystical barrage, they were taken completely by surprise. The mothership was severely damaged, and the aliens suffered over 40% casualties before they even knew they were being attacked. Then the energy animals — birds, monkeys, spiders — came flying into the stratosphere and attacked the mothership, swatting away defending fighters and robots like so many annoying insects. The terrified and shell-shocked Arkhons had no choice but to flee — half of their crew and support ships gone, the mothership's engines damaged, the Arkhons barely managed to use their space-fold systems to leave Earth, never to return, until after the Coming of the Rifts.

The ancient battle was a bittersweet victory for the Nazcans. Almost one-third of the sorcerers who participated in the ritual perished, consumed by the energies they had unleashed. Even more importantly, the ritual drained all the psychic energies of the region, literally "disconnecting" all the ley lines coursing through the area. The Nazcan magicians left Earth and returned to their pocket universe, vowing to return when magic lived again on the world.

The Nazcan decline continued unabated. Although the remnants of Nazcan civilization would continue to exist for several more centuries, their mystical powers were exhausted, dealing a death blow to the already decaying culture. The most powerful line makers left for other worlds, where they would establish their own secret empire. A small handful of shamans continued

to hand down their knowledge over the generations, but many secrets were lost. By 700 AD, the Nazca had practically vanished, making way for other nations and peoples. Yet, even after other cultures conquered the area, the descendants of the Nazca secretly maintained some understanding of the ancient magic and kept the tradition of maintaining and preserving the plateau lines to guard against a possible return of the invaders.

The History of the Old Inca Empire

Inconceivable to modern scholars was the fact that many of the Incan "myths" were actually real stories, handed down and somewhat distorted throughout the centuries, but still essentially true, as were their divine origins. The tales of magic and gods of legend were the reality of an ancient era when magic energy flowed throughout the planet and so-called "gods" walked the Earth. 20th Century occult scholars, like Victor Lazlo (whose theories were scoffed at and rejected), believed some of the ancient cultures were influenced by the Atlantean survivors fleeing the destruction of their civilization. They recognized the mystic significance of some of the prehistoric monuments, but unknown to most modern historians, many of these monuments continued to hold a great deal of mystic power. Power which would be re-awakened with the Coming of the Rifts.

In the history books of Earth, the Inca culture appeared at around 1200 A.D. Over a period of 200 years, this small city-state, based around the city of Cuzco, expanded and conquered all neighboring lands, and had a huge empire covering the Andes mountains, the coastal regions, and even extending into the inhospitable jungles to the west.

The Incas claimed to be descendants of powerful gods and demigods, but such claims were considered myth and superstition. Unknown to the archaeologists and historians of Earth, however, the fantastic claims of the Incas were true.

The Arrival of the Gods

Ancient Cuzco was the location of three, small war-like tribes with little to distinguish them from their neighbors. The history of its people was forever changed by the arrival of a band of transdimensional travelers. These visitors were supernatural beings of incredible power — gods, godlings, demigods, and supernatural humanoids from another world. These beings served the **Pantheon of the Sun**, a powerful collection of divine beings who were aligned with the powers of light (for more information about the ongoing war between the gods of Light and the gods of Darkness, see *Rifts Africa* and the *Rifts Conversion Book Two: Pantheons of the Megaverse*).

The superhuman travelers were the heralds and servants of a powerful transdimensional entity known as **Viracocha**. At the time, Viracocha and his pantheon of gods were actually refugees from another dimension, the losers of a war against the alien race of cyborgs known as **The Mechanoids**. For all their power, the Pantheon of the Sun could not stand against the endless hordes of murderous cyborgs and robots sent against them. The

world they ruled and its ten billion inhabitants were consumed in unholy flames by the relentless Mechanoid fleet. Only the gods and their court, made up of demigods, godlings, and other heroes, were able to escape the holocaust.

During their travels through the Megaverse, Viracocha, Inti, and their followers had heard about the wonders of the magnificent *Nazca Empire* and its untimely demise. Wishing to somehow recreate its glories, and assuming that mystic energy was accessible, Viracocha used most of his remaining power to send him and his court to Earth. The pantheon arrived through a giant Rift that opened over Lake Titicaca, one of the most powerful nexus points in the world. Over three hundred people were transported to Earth, but the gods had erred. The ley line energy was weak and insufficient to support their energy needs.

The Inca gods, utterly drained by the effort of Rifting to Earth, and injured from their battles with the Mechanoids, were left weak and powerless. One by one, the powerful beings slipped into a stasis sleep. In this healing slumber, the gods would regenerate and some day awaken, but in the low energy field of ancient Earth, it would take generations to regain even a fraction of their power.

The nature of the humanoid demigods and godlings who comprised much of the gods' court was different than the gods' (see *Pantheons of the Megaverse* for details and optional player characters), so these beings did not slip into the coma-like state. They found themselves leaderless, weak and alone in a strange new world.

The Birth of an Empire

Manco Capac, son of the sun-god Inti, stepped forward to lead his fellow *Inca* godlings and demigods in a search for a suitable place to settle. After a number of adventures, their trip marred by bickering between Manco Capac and the other godlings, the travelers arrived in the region of Cuzco. At the time, the region was divided among three warring tribes, but the arrival of the superhuman visitors would soon have a profound effect on these people. The Inca demigods and godlings proved to be much more than human, easily convincing the people of Cuzco of their "divinity." The awestruck mountain people immediately accepted their supernatural visitors as "gods" (making no distinction between "true" gods or the comparatively lesser beings known as godlings and demigods). Through the intervention of these "Inca Gods," unity and lasting peace was established between the three tribes.

The sleeping (true) gods were carried to Cuzco and placed in a special building made by the humans under the direction of the godlings. The structure and its location would eventually become known as the *Temple of the Sun*; built on a nexus point where the gods could draw on the trickle of mystic energy that radiated from this junction, could quietly heal in a safe confine, and receive the worship (and protection) of their new subjects.

The demigods and godlings liked the people and adopted them as their "spiritual children," rather than using them as grovelling servants. In return for the people's adoration and service, the Inca godlings and demigods taught them the rudimentaries of sciences, agriculture, engineering, medicine and magic. To the primitive mountain people, these lesser supernatural beings seemed in every way "godly" and the "bringers of knowledge and culture." As a sign of gratitude and respect, the

humans took the name of their gods and called themselves the "Inca." The decades of philosophical, cultural and, occasionally, even physical *union* between demigods, godlings and humans would give rise to the Inca civilization and establish the pervasive belief among the human Inca people that they were all the direct descendants of the gods of the Pantheon of the Sun. The awestruck humans even saw glimpses of the slumbering gods, referred to as the Great Gods. This would one day lead to the practice of mummifying noblemen and other notable people; a practice already practiced by other cultures, and one that would lead to attempts to bring the dead back to life!

Of the legendary Inca Emperors, the first three were true godlings or demigods. **Manco Capac**, the legendary founder of the Inca Empire, was revered as a true god. Under his leadership, the people of Cuzco flourished and the Inca Nation was born. **Sinchi Roca** and **Lloque Yupanqui** followed. Both tried to maintain a peaceful nation, in good terms with their neighbors, but the warlike people of Cuzco ended up resenting these policies and would abandon them shortly after the gods would leave them.

After a number of decades, *each* of the long-lived demigods, in turn, faked his death and was replaced by a successor. This seemed to be a logical practice, because it prevented any one demigod from becoming too powerful or manipulative, and the humans better accepted a "line" of leaders. *Lloque Yupanqui* was the last True Inca godling in the line. It was during his reign that the gods of the Pantheon of the Sun started to stir from their 140 year slumber. Having recovered from their terrible wounds, though still weak, the gods of the Pantheon decided they must leave Earth. The trickle of magic energy on Earth was only slowing down their full recovery, and left them weakened against their enemies. More importantly, they had received calls for help from other pantheons of Light, requesting their assistance in other dimensions. The entire Pantheon, including the demigods and godlings, moved on, leaving behind a human civilization that continued worshipping them for centuries.

The new Inca emperors believed themselves to be demigods, true descendants of the gods, with supreme powers and privileges. Their bodies were mummified and kept in sacred places (just as the slumbering gods had once been kept in stasis). The vision of a huge universe beyond their borders inspired them to explore and expand their Empire, resulting in a series of conquests, starting at the time of the Eighth Inca Emperor who called himself *Viracocha*, after the all-father of the Pantheon of the Sun. Emperor Viracocha and his successors rapidly conquered the lands around them. By 1400 A.D. they had a huge empire that covered about one-third of the entire South American continent!

The Incas continued to worship the Pantheon of the Sun. Using their own skills and talents (magic had all but vanished from Earth), they built huge temples and buildings in their honor. Festivals and rituals honored the gods; some of them included human sacrifices, a practice the gods would not have condoned (but did provide P.P.E. to perform some magic). Compared to the much more bloodthirsty Aztecs and similar Central American peoples, however, the Incas were rather tame and non-violent. Although they conquered many other nations by force, and sometimes were utterly ruthless in suppressing rebellions, the Incas managed to maintain peace and prosperity over their expansive empire.

Roads linked every city and town in the Empire; the Incas built thousands of miles of roads linking the coasts and mountains, reaching as far as the Amazonian jungle. Runners carried messages and edicts through these roads, keeping Emperors and governors informed of what was going on. Agriculture was controlled by the Empire, and a grain tax was imposed; this surplus was stored and used during times of famine. In this manner, there were less food distribution problems than in any part of Europe, where scarcity and famine were still common.

Less than 200 years after the great conquests, however, the Spaniard conquerors arrived to the Empire. The Incas first thought these warriors were the demigods of their legends, come back to lead their people. This and a civil war between the heirs to the Empire weakened the Incas enough to allow a few thousand Spanish warriors to conquer the nation. Thousands of Inca were slaughtered and thousands more enslaved and abused. The conquest process took several decades, but at the end of that period, the Empire of the Sun had been shattered and its gods forgotten and replaced. Elsewhere in the Megaverse, the loss of millions of worshippers severely weakened the Pantheon of the Sun, who were at the time engaged in a savage war against the Gods of Darkness and their demonic host. The Inca Gods were nearly destroyed, and once again they had to enter a mystical slumber, this time in a small dimension linked to Earth by small dimensional portals built into *Huacas* (holy places, most of whom were built over ley lines and nexus points). Their faithful demigod servants, led by Manco Capac, guarded the gods for centuries.

The Return of the Gods

The Great Cataclysm & New Empire of the Sun

The Coming of the Rifts was a momentous time for all of Earth. As mystical energies exploded from ley lines and nexus points, and waves of magic triggered earthquakes, storms and worse, the attention of many beings of power was suddenly focused on this largely ignored planet. Many old gods decided it was time to return. Some built new cities for their worshippers, like the feline deities in charge of **Omagua** (see *Rifts South America: One*). Others visited the planet only when great dangers threatened it, like the *Pantheon of Ra* has done in Africa during the coming of the **Four Horsemen of the Apocalypse** (described in *Rifts Africa*). And still others, the *Pantheon of the Sun* among them, decided to return to the place of their origins, the mountain city of Cuzco.

The surge of dimensional energies awakened the gods of the Sun Pantheon. Viracocha again led his people to Earth, through the Rift that opened over Lake Titicaca. The gods and their servants arrived amidst chaos and confusion. Civilization was crumbling all around. Undeterred, Viracocha marched towards the ancient capital of Cuzco. Thousands of humans who recognized the old gods followed them, which meant that most of these worshippers were spared from many of the lethal dangers that beset the world with the primordial spasms of rebirth. Viracocha and his fellow gods and goddesses were glad to help their

new “subjects.” The Earth of this new era surged with incalculable amounts of mystic energy, which served to enhance the gods’ magical powers.

During this odyssey, the Inca gods experienced their first contacts with modern technology. A Peruvian armored battalion, mobilized shortly before the Rifts to protect a vital mountain road, attacked the travelers out of sheer panic. Although the gods were able to easily disable and destroy dozens of tanks, helicopters and other vehicles, the concentrated firepower of the terrified humans was enough to kill several godlings and demigods, and to severely injure some of the lesser gods of the Pantheon. Viracocha soon realized that technology was something to be respected. Despite this and other dangers, the Inca gods and their followers made it to Cuzco, where they used magic to rebuild the ancient city on the ruins of the modern metropolis.

Elsewhere in the region, other major events were taking place. In the *Nazca plateau*, the line drawings flared to life. Ancient half-erased marks on the ground suddenly became walls, buildings and towers! Some of the fabulous cities of Nazca were reborn — ancient magic feeding off the ley line energies that once again pulsed with power. Two of the cities were occupied by the heirs of the Nazca culture, led by a band of a long-lost descendants of the line makers who had fled Earth during the fall of Atlantis. The returning Line Makers used their powers to protect the area’s population from the brunt of the erupting ley lines and the Great Cataclysm.

The Cataclysm that engulfed the planet was less kind to the nations of Peru, Ecuador and Bolivia, where only scattered bands of refugees survived — millions perished. Only the city of **Arequipa** (described elsewhere in this book) managed to survive, and even in that case it was a shadow of its former self. For several years, the three major powers of the area, *Nazca*, *Arequipa* and *Cuzco*, grew in power independently of each other. As each city-state started growing in numbers and power, they came into contact with each other.

The Incas and the Nazcans were the first to face each other. The magic of the Nazca cities was too powerful and impressive to not be noticed by the gods. An embassy was sent to the Nazcans, offering their cities membership into the Empire of the Sun. At first, the Nazcans hesitated, leading to almost ten years of negotiation and political intrigue. Neither side wanted to start a war with an unknown but obviously powerful enemy, so they relied on their ambassadors and emissaries to try to work out an amicable agreement.

The situation changed when a band of **Larhold Barbarians** (see the *Larhold Threat Section* for more information) Rifted near the Nazca region. The savage dimensional raiders ran rampant through the Nazca cities, taking the mage-kings by surprise. The Larhold shamans used their *Blue Flame* to weaken and topple some of the mighty energy walls. By moving quickly, the barbarians overran the Nazca lines, cutting the people off from their most powerful line of defense. Besieged and desperate, the Nazcans appealed to Viracocha and the Pantheon of the Sun for help. In return, they agreed to become the vassals of the Empire. Viracocha agreed to the terms (in a hurry, for he had no desire to see the magnificent cities fall), and he sent his best warriors forward, led by a host of True Inca demigods. Trapped between the surviving walls of Nazca and the Inca armies, the Larhold withdrew, and the marauding raiders were pursued all the way across

the Andes mountains. Less than one in ten of the Larhold survived the harrowing trip, hounded at every step by the Inca forces and vengeful Nazcans. Shortly thereafter, Nazca became part of the Empire of the Sun. The powerful Line Makers became Inca nobles, and they taught the secrets of their mystic arts to the Incan people, both mortal and immortal.

The city of **Arequipa** became a technological enclave. Its inhabitants eventually became Inca subjects, but on their own terms (see the *City of Arequipa* elsewhere). Combining technology, magic, and line making, the Inca Empire grew and prospered. By the year 20 P.A., the Empire of the Sun encompassed the borders of the old Empire and beyond. At the time of greatest expansion, the Incas controlled the entire West Coast of the continent, from the Northern Andes (reaching to what is now the Vampire Kingdom of Hakla, see *Rifts South America: One*) to the tip of the continent in the south, and reached inland as far east as the shores of the Greater Amazon river.

Unfortunately, later developments reduced the span of this mighty Empire. First, around 50 P.A., the transdimensional slavers known as the **Dakir** built a stronghold in the mountains west of Lake Titicaca. The Dakir and their slave soldiers were so well-armed and equipped that not even the Incas were able to dislodge them. Through their stronghold, the Dakir controlled most of the mountain passes in the region. This impaired trade and communications with the cities deep inland. Cut off from the Empire, these cities eventually vanished as their inhabitants migrated back to the coast, perished, or were conquered by the rising nations of *Santiago* and *Cordoba* (see the *Silver River Republics* for more information). Furious at their losses, the Incas are in a constant state of war with the Dakir. Even though the slavers have been overthrown (see the *Megaversal Legion* for more information), there is much distrust and suspicion towards the alien mercenaries.

The second upheaval was even more severe: the arrival of the Arkhons.

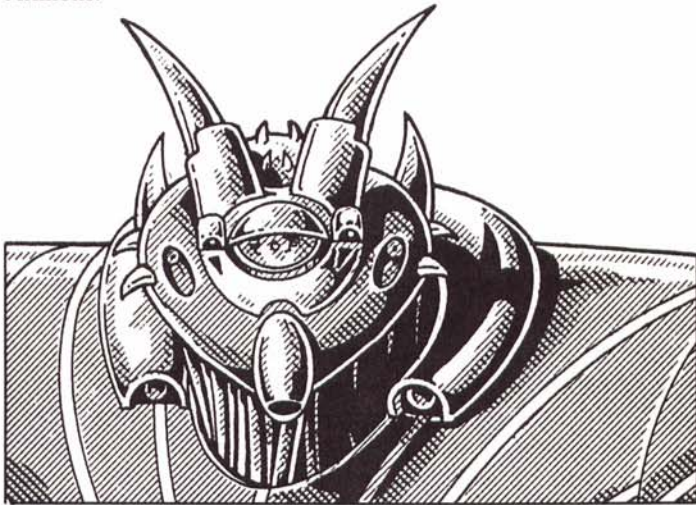

The Arkhons

In the year 74 P.A., the alien invaders the Nazcans had foiled thousands of years earlier, returned in force. The *Arkhon* invaders were prepared to completely destroy the Nazca lines and conquer the world, starting with South America. It was only chance and the Arkhons' foolish miscalculations that prevented them from doing so. The aliens had not taken into account the

passage of time and the great advances the people of Earth may have made. Consequently, when the massive space fleet warped into orbit around the Earth, they were bombarded by the pre-Rifts space defense network and moon base survivors before they knew what hit them (see *Mutants in Orbit* for details about post-Cataclysm space survivors and killer satellites). Furthermore, the rash invaders were taken by surprise by the incredible changes on Earth and the immense dimensional energies and anomalies that pulsed through and around the planet. Between the space defense network and dimensional anomalies (one-third of the fleet disappeared without a trace — never coming out of the space warp), the fleet was decimated!

A large percentage of the Arkhon survivors managed to enter Earth's atmosphere, just above the Nazca Plateau. Although blue energy coursed through the magic, desert line drawings (threatening a previously unparalleled power of destruction), this time, the Line Makers were taken by surprise! Only a few minor defenses were activated in time to save the Nazca Lines from an aerial bombardment. It was only the fact that the alien ships were so badly damaged and its troops so shaken and disoriented by the time they reached their target, that saved the lines and line makers from utter destruction.

Crippled and disoriented, the remnants of the Arkhon fleet limped away as soon as only a few magic drawings flickered to life. The aliens found seclusion in the mountains of what had once been *Ecuador*. There they decided to make their stand and to establish an Arkhon stronghold. Hundreds of thousands strong, and equipped with high-tech weapons and machines of war, the Arkhons ravaged human villages, killing hundreds of innocent humans and D-Bees and enslaving thousands more. The Inca warriors in those remote areas lacked sufficient firepower to stop the invaders, thus, the Arkhons were able to salvage some measure of success out of utter defeat.

Emboldened by a series of easy wins, the aliens tried to expand further, but they encountered fierce magical and technological resistance. Dragons, demigods, gods and sorcerers met the power armored troops and tanks of the Arkhons in fierce battle. Losses were heavy on both sides. The war soon subsided to a limited conflict where skirmishes were more common than full-fledged battles. The one bloody exception was the battle of Humari, in 85 P.A.

The Battle of Humari and its Aftermath

The deciding battle in the Arkhons' bid for conquest was fought in the district of Humari, a relatively prosperous region of the Inca Empire. In an effort to gain a foothold in the Inca territories, three Arkhon Armies (a force about 60,000 strong) poured into the territory. Stealth aircraft and power armor initiated the attack by launching surprise bombing runs against towns, cities and barracks. Over 5,000 people, most of them innocent civilians, were killed in the first minutes of battle. Then the Inca defense systems went into action. Nazcan line makers activated their energy grids, and dozens of Arkhon aircraft were knocked out of the sky by a bombardment of mystic energy. At the same time, however, the main body of the Arkhon invasion force fought its way into Humari. The local Inca forces, outnumbered and outgunned, were overwhelmed. A force of 500 soldiers, 200 superhuman Inca Warriors, 20 Rune Warriors and 10

True Incas (gods) acted as a rear-guard to allow the Incas to retreat and reorganize. These heroes stopped an armored division on a narrow mountain pass, and stalled the Arkhon attack. Of the 730 heroes, only 82 survived, including 3 True Incas. The Arkhon lost over a dozen tanks, twice as many robots and power armor and 2,000 soldiers. By this point, however, the Empire of the Sun had mobilized their army; the Arkhons, having lost the initiative, could not advance further. At that point, the Nazca Line Makers raised the Monkey and the Hummingbird from the Nazca Line plateau. These giant energy beings smashed the Arkhon lines, killing hundreds of soldiers and completely disorganizing the troops. The Hummingbird was "destroyed" by concentrated gunfire from the alien tanks and robots, and the Monkey was finally dispelled by the magicians when the energy expense became too extreme, but by then, the damage was done. The Arkhons were forced to retreat.

The final tally, counting the losses above, was over 20,000 Inca subjects dead (one-third of them civilians, women and children) and twice that many injured. The Arkhons lost 12,000 soldiers and nearly 200 combat vehicles, with three times as many vehicles suffering serious damage. The victory lay with the Incas, who had been able to stop the massive siege. Since then, no major engagements have been fought, however the Arkhons' influence and threat remains unabated.

The alien warriors have successfully captured and cut off a number of cities from the Empire of the Sun. The most important isolated area is the city of **New Quito**. Despite a number of savage attacks by the Arkhons, the city holds on, and remains loyal to the Incas. Over the last decade, New Quito has continued to fight, supplied by sea. In some ways, the situation in New Quito has benefited the Empire of the Sun, because it has prompted the Incas to develop a Navy, something they might not have done otherwise.

The war rages on. The Incas have been unable to push the Arkhon invaders out of their mountain strongholds. The **Pantheon of the Sun** has considered intervening, but they fear that the aliens might, in desperation, resort to weapons of mass destruction, including strategic nuclear or anti-matter weapons. Millions would be consumed in the ensuing holocaust, and even the gods themselves might be destroyed. Should such a dire state of desperation ever occur, Viracocha and the other gods will try to intervene in full force, hoping to overwhelm them before such weapons can be deployed. For the time being, they wait and leave the fight in the hands of humans, and godlings and other superhuman followers.

Government & Society

Population Percentage Breakdown by Race:

28% Descendants of the Inca

10% Descendants of the Nazca

30% Other South American/Peruvian People

28% D-bees

1% Godlings & Demigods

3% Other

A dozen true gods live in the Empire of the Sun.

The Empire of the Sun is a curious mixture of the Inca traditions of old and modern republican principles. In some ways, the Inca nation is a constitutional theocracy, with the bulk of the power resting in the hands of the gods, their priests, and servants. At the same time, the deities and their appointees are responsible for the welfare and happiness of all the people.

As one might imagine, the leaders of the Empire are members of the *Pantheon of the Sun*. There are ten "true" gods in the Pantheon, plus an additional 300 godlings and 10,000 demigods (see the **True Inca R.C.C.**, below). For the most part, however, the gods do not meddle *directly* in the affairs of their people. Instead, they leave most of the decision-making to the *Sun Priests*, led by the High Priest. The High Priest is a political and religious office, typically filled by a mortal human who has proven himself in both piousness and wisdom. He is looked at for guidance and rulings. Occasionally, when facing difficult or obscure choices, the High Priest will retreat to the Temple of the Sun to confer with Viracocha or other gods.

The High Priest acts roughly like a President or Premier; he can declare war, issue decrees and veto laws. The main ruling body of the Empire is a new development, based on 20th Century governments. **The Parliament of the Sun** (as this ruling body is called) is also a combination of religious and political organizations. The Parliament has 400 members; 30% of the members are priests appointed by the High Priest; these appointments are for life, unless crimes or inappropriate conduct are proven to be grounds for dismissal. The remaining 70% are elected representatives from the diverse Imperial Districts, chosen through local elections every five years. There are no political parties in the Empire of the Sun; each representative has to convince the local population to select him or her. The Parliament of the Sun passes laws, drafts resolutions, and decides on most matters. The High Priest, or the gods themselves, have veto power over any of their decisions, and such a veto is not revocable. So far, however, the veto power has never been invoked, which maintains the illusion that the Parliament is the most important part of the government.

In ancient times, the human Inca people had a number of social divisions, with noblemen above commoners and peasants. The new Empire of the Sun has revived the concept of nobility, but has now based it on achievement rather than lineage. To achieve Noble Status in any profession, craft, or even hobby or artistic expression, applicants must pass a number of tests. These tests are administered at district capitals, which makes it more difficult for poor people living in remote areas, but theoretically everybody has the right to attend the tests. Those who pass the very strenuous tryouts are given the rank of Noble in the specialty of the test. So, for example, somebody could be a Noble in swordsmanship, or piloting, after passing those tests, but fail in boxing or music. In game terms, to pass such a test the character must have a minimum level of 80% with a skill, or +5 to strike with a weapon skill (counting all bonuses), to hope to qualify as a Noble.

Nobles earn more pay and have more recognition than "commoners," but have few other special privileges. As a symbol of their status, nobles usually wear large earrings, the origin of the name *Orejones* ("Big Ears"), which is the common title of high-ranking subjects. Nobles are also allowed to accumulate wealth, something that most commoners cannot do; most property is



owned by the Empire of the Sun, and given out or shared as need dictates. Food is stored in common warehouses, to be distributed in time of need. All members of the Empire owe a labor tax (called the *mita*); with this labor (ranging from menial work to professional services like engineering, construction and administration), public roads, bridges, fortresses and similar structures are built.

If there is a true noble "class" it is held by the priests and practitioners of magic. They represent the political power in the Empire, possess the most influence, and garner the greatest respect among most people. This is due to the fact that their powers are real, impressive, and potentially dangerous, as well as usually having been chosen by the gods as their favorites. Additionally, magic and psionic abilities are generally considered "divine powers," shared by man and gods alike.

Daily life in the villages where the majority of the population lives is not very different from the ancient Andean ways, a way that continued to exist through the 20th century and even the pre-Rifts years. Villagers share their farm equipment, food, and other products. Living conditions are fairly primitive; only health care (each village has a healer trained in both holistic and modern medicine, and 60% of all villages have somebody with psionic or magic healing abilities) is provided. Each village has 1D4 computer terminals (used on a time-share basis), twice that many radios, and perhaps one or two television screens (typi-

cally very large, movie-screen size sets) on which the government channel can pass on important news and announcements as well as a number of programs teaching history and mythology. Outsiders find Inca television to be excruciatingly boring.

Every village has an armory with 5-100 energy rifles, 5-50 energy pistols, 50-500 grenades, and 5-100 suits of body armor. This armory is under the control of the village Prefect, and is opened only in cases of emergency. Typically, there is enough weaponry to outfit half of the adult males of the village. As part of their *mita* "labor tax," all male villagers have to qualify with a weapon and have some military training; all Inca males of age 16 have hand to hand: basic and either W.P. energy rifle or W.P. assault rifle; about 40% have both. The subjects of the Empire must also perform military maneuvers and patrols once a month, arranged so that about one-tenth of the militia is on patrol at any given time.

Life in the "free cities" is very different. These technological enclaves have more in common with the cities of the Coalition States and the NGR than with the primitive villages that surround them. Almost every household (except in the poorest areas and slums) have personal computers that double as telephones and T.V. sets. In addition to the official Inca Channel (which has the lowest ratings), half a dozen other channels air pre-Rifts and modern movies, soap operas, and variety shows. The attraction of this way of life often prompts people to leave their simple villages and try their luck in the cities. Migration into the cities is strictly regulated, however, and those who try it without government permission are often forcibly relocated. Those who manage to *sneak* in, often end up living in slums under subhuman conditions, and decide to voluntarily return to their simpler but safer and more peaceful lives.

The government of the Empire of the Sun is not loved by everybody. Many villagers envy the cities and the luxuries there. Many people do not want to miss out on the privileges of the noble class and the city technocrats, whose members can enjoy owning vehicles, computers and high-tech weapons and equipment, while the rest of the folk have to use community tools, many of which are old or of poor quality. Some of the discontented have started riots, have abandoned the Empire to form their own settlements, or joined other nations (such as the technologically-oriented **New Peru**). In some instances they have started revolutionary movements to change or overthrow the government. The most notable of such movements is the ancient Communist guerrilla group known as the **Shining Path** (see the *Other Republics Section*, elsewhere). Despite its failings, the government does a good job in providing for the people, and compared with the chaos and carnage of the Great Cataclysm, invading aliens, and other kingdoms, the Empire of the Sun is a paradise.

The Sun Priesthood

Priests of the Sun are the servants of the gods. To the eyes of most common people, these men and women have been granted the enormous honor of serving as the gods' eyes, ears, and weapons. Priests are selected from young volunteers of both sexes at an average age of 12, but ranging from 10 to 17 years old. The acolytes then spend four years learning the traditions and mysteries of the Pantheon of the Sun. About 70% of these students become Priests Minor, servants of the cult who do not have any

priestly powers and act as servants, guards and other honorable but low positions. The *gifted* 30% become full-fledged priests, able to heal the sick and perform miracles. Priests of both varieties attend to the needs of the gods, godlings and demigods of the Sun Pantheon, as well as function as public servants and political and religious leaders. Depending on the rank and talent of the individual priest, they act as servants, bodyguards, advisors, and liaisons between mortals and immortals. For a full description of the duties, privileges and powers of the priesthood, see the **Sun Priest O.C.C.**, described below.

The Nazca Line Makers and Other Magicians

Practitioners of magic are held in high regard by the Incas. In ages past, the Pantheon of the Sun worked alongside Atlanteans and other masters of magic. The Nazca Line Makers are admired by all members of the Empire, both mortal and godlike. This respect also assumes a number of things about magicians. For one, all magicians should, theoretically, be ready to serve the Empire of the Sun at any time, although in practice, many of them seem ready to serve only their own ends. Magicians have a status similar to the militia or military reserves in modern nations; in case of emergency, they can be called up to use their powers in the service of the Empire. The war with the Arkhons has often necessitated such calls to duty. On more than one occasion, it was only the ability of these men and women of magic that turned the tide in favor of the Incas.

In addition to the line makers, other common magicians include mystics (heirs of ancient magic traditions of non-Inca natives), stone masters (who learned such secrets from the Atlanteans millennia ago), tribal shamans, and ley line walkers. Certain types of magic are not favored in the Empire of the Sun. *Necromancy* and *dark witchery* are universally repudiated and persecuted; anybody even suspected of such foul practices is expelled or executed summarily. *Summoners* and *shifters* are viewed with distrust, due to the fact that many of them serve alien powers who may not have the best interests of the Empire at heart. Although not persecuted like witches or necromancers, shifters/summoners who show signs of having made a pact with a supernatural being risk being exiled or worse. The laws are equally harsh for those who use their powers to exploit, abuse, con or extort the innocent. Since the Inca soldiers, who also act as peacekeepers, have a high percentage of mages and priests among them (accounting for almost 20% of their forces!), identifying and dealing with such crimes is relatively easy.

As long as practitioners of magic behave themselves, obey the law, and don't abuse their special abilities, the Empire treats magicians as elite members of society. Any citizen of the Empire with an aptitude for magic can study at the arcane universities located at *Cuzco*, *Nazca* and *Ucayali*. All spell magic from levels 1-6 can be learned at those universities, and many of the more advanced spells can be made available to "worthy" students. "Worth" is measured by power, dedication and past service; a young mage is not allowed to learn the more powerful spells until he can prove these things. Such proof might include undertaking a quest or a mission for the Empire, having saved an important priest or a demigod from a lethal danger, performing heroically in combat, and similar service or acts of patriotism.

The Ancients

After their gods left, the human Inca continued to venerate the royal family that followed in the footsteps of the gods as leaders of the Inca Empire. These human monarchs were at first faithful worshippers, but some of them came to believe that they were true gods. Many of these Incas wanted the immortality they felt was their due, and used magic techniques to leave their souls in their bodies after death! Many were inspired by the tales of the ancient gods who had arrived in slumber and then been placed in mystical places to protect them until they awakened. These holy places, known as *huacas*, were typically located near or on ley lines and nexus points. To emulate their gods, the human Incas mummified the bodies of certain nobles by freeze-drying them in the mountains. Spells and incantations performed during the mummification process helped bind the Incas' spirits to their bodies. The mummies were then placed at huacas, where ley line energies kept the spirits in a state between life and death.

This necromantic practice would not have been condoned by the Pantheon of the Sun, but the gods and demigods were long gone, embroiled in other conflicts throughout the Megaverse. When they came back during the Great Cataclysm, the damage was already done, and the Ancients walked the Earth once more!

For a thousand years, these mummies slept in a seemingly eternal slumber. Once or twice, one of these ancient beings would be awakened, but Earth's energies were too low to permit them to return to life. When magic energy washed over the planet during the Great Cataclysm, the ancient spells were revitalized, and the Ancients awoke. The process had turned the withered mummies into immortal, incredibly powerful beings. It had also made them insane and evil, twisted mockeries of what they had once been. The Ancients needed the life energy (P.P.E.) of sentient beings to survive. They obtained it through a lethal draining touch that withers victims in less than a minute! Additionally, they have a great deal of magical and psionic power, making them very dangerous enemies. One such power is the ability to transform their victims into zombie-like creations, thus a powerful Ancient can create a small army of undead servants.

The Ancients are few in number. The human Inca of the Empire of the Sun think there are less than a hundred throughout the Empire — in reality there may be as many as three or four times as many (plus a handful have awakened in other lands, taken from Peru as museums artifacts and the subjects of scholastic study). Filled with hatred towards all living things, but above all, against the true Inca gods, the Ancients plot against the Empire of the Sun. They live in the most remote areas of the forest or jungle, where they slowly work for the downfall of their descendants. These undead would want an alliance with the Arkhons, but for the time being the aliens are too scared and suspicious of these undead horrors. The Ancients will also work with other undead, demons, devils and supernatural intelligences. There are rumors of Ellal (see *Rifts South America: One*) working alongside Ancients, but none has been confirmed.

Note: The most powerful and fearsome Ancient is the undead mummy of the former **Emperor Yahuar Huacac, the Blood Weeper**. This savage tyrant, both during his life and in undeath, is a major threat for the Inca Gods, people and Empire.

Foreign Affairs

The Arkhons: The Empire of the Sun and the Arkhon Freehold are at war with each other. Currently their clashes are conducted as a dirty guerrilla war. The Arkhons often strike at helpless villages and towns. The Inca retaliate by sending magical storms and earthquakes against the Freehold's enclaves. Skirmishes with less than a hundred soldiers on each side are the norm; both sides strike quickly and retreat before air support, artillery or demigods, sorcerers, and powerful spells can be called down upon them. On a couple of occasions, one of the gods themselves launched attacks against the Arkhons, but the deities are being cautious for fear of nuclear retaliation. A team of True Incas (demigods and godlings) once tried to assassinate Warlord Enno, but the Arkhons' psionics were able to detect and stop the attackers.

The Silver River Republics: The Empire of the Sun is isolated from most of the SRRs, with the exception of the republics of Cordoba, Santiago and *New Babylon* (see below). Relations with Santiago are cold but rarely hostile. As long as both sides respect the informal borders between them (and they usually do), peace is assured.

Cordoba is another matter altogether. This aggressive nation has often launched raids into Inca territory, despite the dangers from both the Incas and the marauding Arkhon aliens. If the two nations didn't have more important things to deal with, they would have been at war long ago. Even now there is an unofficial state of war between the two, with each attacking interlopers in their respective territories without regard to the actual innocence of those involved. Furthermore, any travelers in the area risks being attacked by one or both sides. Acts of sabotage, spying and banditry are constantly waged against each other.

New Babylon: This prosperous human and D-Bee enclave trades with the Incas on a regular basis. Cultural, trading and diplomatic exchanges are common, with weapons, magic, art and fashion being the primary staples. Babylonian technology supplements what is produced in the free city of *Arequipa* (see below). In return, they acquire Inca works of art, magical items and raw materials. The Babylonians are fascinated with the culture and gods of the Empire of the Sun, and the Inca are often amused by the swashbuckling antics of both the alien and human members of New Babylon. Although the two governments are very friendly, the two nations are not formally allied to each other.

The Megaversal Legion (Dakir): This transdimensional mercenary force is distrusted by most members of the Empire. The crimes the Dakir committed when setting up their base are not easily forgotten, even 50 years later. At best, they are treated with coldness and respect, but not friendship. At worst, they are attacked at the slightest provocation. The alien D-bees in the Legion cause many natives to fear that organization, and even the human soldiers are identified with the ancient "Americans" who are still hated by many imperials of Peruvian descent. Despite the fact that the Legion has fought the Arkhons, no formal alliance or treaty has ever been signed, nor is likely to be.

Manoa (El Dorado): This mythical city was founded by Atlanteans fleeing the fall of their civilization, but after magic continued to wane it was moved to another dimension. The city returned shortly after the coming of the Rifts. The Incas know of this city's existence, but have no wish to become involved with

it. The Nazca line makers in the Empire blame Atlantis for the downfall of their civilization, and want nothing to do with them. The Inca gods concur. Although they know most True Atlanteans are on the side of Light, they are suspicious of those transdimensional exiles, and prefer neither to attack nor parley with them.

The Other Cities of El Dorado: Two other great cities rise in the jungles of South America; one, *Omagua*, is peopled by feline mutants and supernatural beings; it too is ruled by gods. One of the ruling deities of Omagua is the Jaguar god *Yaguar-Ogui*. This god has lost many worshippers during the Inca expansion, and he blames the Pantheon of the Sun for it. For that reason, relations are strained between the two theocracies. Although they are geographically too far apart to become involved in a conflict, encounters between the natives of these two civilizations are likely to become ugly.

The other city is *Cibola*, another mythical gilded city. Cibola is ruled by supernatural monsters, led by the evil Soul Worm known as *Inix*. The Incas have heard rumors and tales of this city, but are not concerned with it, as long as it doesn't threaten their dominions. Unknown to the Incas, however, spies from Cibola are beginning to learn about the Empire and the Arkhons. They have yet to report to Inix, but when they do it is likely that Cibola will try to somehow profit at the Incas' expense.

Note: The three cities of El Dorado, their peoples, magic and technology, are fully described in *Rifts World Book Six: South America One*.

The Republic of Colombia and the Kingdom of Haktla: The Empire of the Sun borders on the North with the warring vampires and humans described in *Rifts South America: One*. Sometimes, Colombian patrols have clashed with Inca forces, but for the most part the two human nations leave each other alone. The Incas will not abide vampires in their territories, and their sun powers terrify most Undead, so very few vampires ever dare venture into the Empire.

The Coalition States: The CS know nothing about this kingdom and are busy with their own machinations in North America.

The Splugorth of Atlantis: The Splugorth have heard tales of a city of gods and magic, but have yet to investigate.

Cities and Places of Note

In addition to the cities briefly described in the next few pages, only about half a dozen population centers with more than 10,000 people exist in the Empire. They include **Ucayali** (pop. 35,000), best known for the second largest school of magic in the region, **New Quito** (pop. 60,000), which is isolated by land from the rest of the empire, and **Ancon** (pop. 40,000), built around a large military base that acts as a shield against Arkhon attacks. Most of the rest of the population lives in small villages or towns. The typical village has 1D6×100 people while the average town has about 1,000 people. Most are simple farm communities.

Cuzco, the Imperial Capital

Population: 300,000

Cuzco has undergone several transformations in its history. The city was the capital of the original Inca Empire at the time

of the Spanish conquest. Afterwards, it became an important Peruvian city. The Great Cataclysm devastated the modern city, leveling almost every single building and flattening most houses. With the help and powers of the Pantheon of the Sun, the city has been rebuilt in the likeness of the ancient Inca city.

The Great Temple of the Sun dominates the city. This walled structure has been plated with solid gold and stands 500 feet (152 m) high, supported through the use of stone magic. When the sun shines on the highly polished gold, the building reflects it with near blinding intensity, looking like a miniature sun. During special magical ceremonies, the building glows with its own supernatural light even during the nighttime; the magical glow is enough to create a false day across the entire city. It is important to note that this illumination is powerful enough to scare and harm vampires and other creatures who are affected by normal sunlight (but at half the usual damage and effects from normal sunlight). The source of this supernatural light is believed to come from *Inti, the Incan Sun God*.

Most of the interior of the temple is empty; save for twisting balconies and a ramp on one of the walls that reaches to the top of the structure, the rest of the temple is open space. The balconies can accommodate as many as 50,000 spectators, more people than live in most cities of Rifts Earth! A giant skylight lets the sunlight illuminate the inside of the whole complex. A large (20 feet/6.1 m tall) altar is the centerpiece of the structure. The High Sun Priest conducts all major ceremonies there. Near the top is a narrow strip leading to twelve doors. These doors are dimensional portals that lead to the private residences of the gods of the Pantheon of the Sun. Each god dwells in a small pocket dimension. The twelve portals can also be made to transport the gods or their servants to several hundred other dimensions. The Inca gods sometimes travel to the domains of other deities, although they avoid most transdimensional centers, including *Splynn* (at Atlantis) and *Phase World*.

The second most important area in the city is the **School of the Arts**. This university was built when the True Incas gathered all the surviving sages and scholars they could find in an effort to preserve their knowledge. Although all subjects are taught in the school, its major strengths are in the liberal arts, social sciences, and the study of magic. The School of Magic is a strange place, a heavily fortified building where mystics, ley line walkers, stone masters and a dozen other strange and often conflicting methods of magic are taught. Elementals, entities and other supernatural beings occasionally get loose and wreak havoc through the school halls; fortunately, many magicians and priests are there to deal with the situation before it gets out of hand.

The Great City of Nazca

Population: 230,000

The foremost of all the revived Nazca cities, the Great City is a glorious remaking of the awesome feats of the True Nazca Culture. Like all the cities of that ancient civilization, many of the buildings use no stone, rock, concrete, wood or metal. Instead, the imposing palaces, walls and towers are made up of solid green and red energy, glowing with their own light and harder than any normal building material! There are six domed towers in the Great City; each of them stands 1,500 feet (457 m) tall. The towers are used as watchtowers and the center of many

magical ceremonies. The four City Warders live in the towers. Each Warden is a powerful Line Maker (10th to 14th level), and has full access to the energies of a nexus point located right below each tower. Other energy buildings include the Imperial Palace, where the Inca authorities and the local city government conduct business, and the Temple of Dawn, where the Pantheon of the Sun is worshipped. The city's defensive walls are also made up of solid energy. In an emergency, the walls can encompass the entire city in a nearly unbreakable shield (700,000 M.D.C. are needed to breach the dome).

Many of the smaller buildings and houses are built with conventional materials. The Nazcans have realized that depending solely on magical energy is foolish and arrogant, so 60% of all dwellings use normal S.D.C. or M.D.C. brick and concrete, but the streets themselves are "paved" with the magical energies of the ancient lines. Magical signs are "programmed" to give directions to tourists or newcomers. Should attackers ever enter the city, drawn wards and circles can fire energy bolts from every street corner (these magical attacks can inflict from 2D6 M.D. to 1D6x10 M.D., and are at +4 to strike). Other wards raise energy walls to cordon off streets. Arkhon strategists have calculated that any attempt to take the city by storm will fail, with the attacking forces suffering losses as high as 90%.

The Free City of Arequipa

Population: 200,000

Arequipa was an important Peruvian city which, up to the turn of the 20th Century, had only dealt with light industry and commerce. The "New Cold War" of the 21st Century prompted the construction of several military facilities in the city, which would be used as a shield against possible invasions from other nations. A number of factories were also built there, greatly increasing the size and population of the city (which nearly tripled, from 500,000 in the 1990s to 1.3 million in 2020). When the Great Cataclysm struck, Arequipa's proximity to the mountains saved much of the population (about 50%) from the tidal waves, and the military helped protect the survivors from monsters and other disasters. While the New Inca Empire was being formed in Cuzco, the survivors of Arequipa worked hard to maintain and rebuild their technology. A number of simplified versions of pre-Rifts power armor, robot vehicles and light armored vehicles and helicopters were kept in production.

When the Incas of the Empire of the Sun and the Arequipan citizens met, almost a decade after the cataclysm, diplomacy prevailed. The Arequipans were in awe of the mystical power of the "gods" and their followers, and the Incas realized that technology was a necessity if their Empire was to survive. Rather than force submission upon the city (an undertaking that would have led to a savage war), *Manco Inca* offered Arequipa "free city status," allowing it to rule and control its internal affairs, while accepting overall leadership from the Empire. In return, the Arequipan industries would provide the rest of the Empire with technological items, from weapons to farm machinery. With a few exceptions, including a couple of nasty incidents that ended up in bloody skirmishes, the arrangement has worked very well.

The standard of living in Arequipa is the highest in the Empire of the Sun. Most of its citizens are literate, well-trained factory workers, engineers and designers (90% literacy). Since the

city effectively has a monopoly in the high-tech arena, except for trade with New Babylon, it has become incredibly wealthy. This wealth has caused problems, however. Many peasants from neighboring villages have migrated to the city, violating Imperial edicts, to make their fortunes there. Many of these unfortunates end up working in menial occupations, risking being discovered and deported by the authorities. Most of these migrants live in run-down sections of the city, where crime is rampant and living conditions are far worse than those that could be found on a farm. There is a high turnover of migrants, as many discover city life is not all it was cracked up to be and return to their villages; others are preyed upon by criminals, and a small percentage actually make it and become prosperous factory workers or merchants. Some of the most frustrated migrants end up joining revolutionary groups like the Shining Path.

These slums are sometimes used as the hunting grounds for supernatural predators. The Inca authorities do their best to root them out, but weird murders still happen. Drug dealers, prostitution, gambling rings, and the black market all operate among the poor and destitute.

Lima

Population: 50,000

The traditional capital of Peru, Lima was unfortunately a coastal city. The Great Cataclysm generated huge tidal waves that washed the city of all life, killing over five million people as waves rushed through the streets, toppling buildings and drowning helpless victims. The tidal waves retreated to some degree, but they still left one-third of the city under the sea. For centuries, the city remained an uninhabited ruin, frequented by small tribes of scavengers. Inca colonists started rebuilding the ruins and tried to salvage some of the huge industrial capacity of the city. Eventually, 10,000 professionals from the Free City of Arequipa relocated there and formed the core of the reconstruction efforts. When the need to build a navy became apparent, Lima became the Empire's largest shipyard, and most of the medium and heavy warships of the Navy of the Sun are built there.

The City of the Dead

Population Breakdown: 100,000, including about 30 Ancients, 20,000 minor undead (zombies, skeletons, etc.), 500 vampires, 1,000 assorted minor demons, 1,000 entities, and thousands of human and D-bee slaves and fanatical followers.

Nobody knows exactly where this dreaded city is, but its existence is a source of fear and suffering throughout the Empire. The City of the Dead is the mountain fortress of the undead Inca Emperor Yahuar Huacac, the infamous Blood Weeper. This city is ruled by the Ancients, undead mummies of noble Incas. Many other supernatural creatures have joined the Ancients since the founding of their foul city. Among them is a master vampire, the servant of a powerful vampire intelligence who is contemplating settling on Earth. Emperor Huacac has consented to allowing the creation of a master vampire and a few hundred vampires, but he is concerned at having such a powerful rival to contend with.

The city is surrounded by eternal mists, so uninvited travelers will almost always (90% chance) become lost in the mists. Ultimately, they find themselves on the other side of the mountain range without coming even close to the City of the Dead; many disappear without a trace. Aircraft flying into the mist are almost

always lost (destroyed or sucked into another world? Nobody is sure). It is possible that the City of the Dead is a dimensional anomaly like the Yucatan Peninsula (see *Rifts Vampire Kingdoms*), surrounded by Rifts and dimensional pockets and portals.

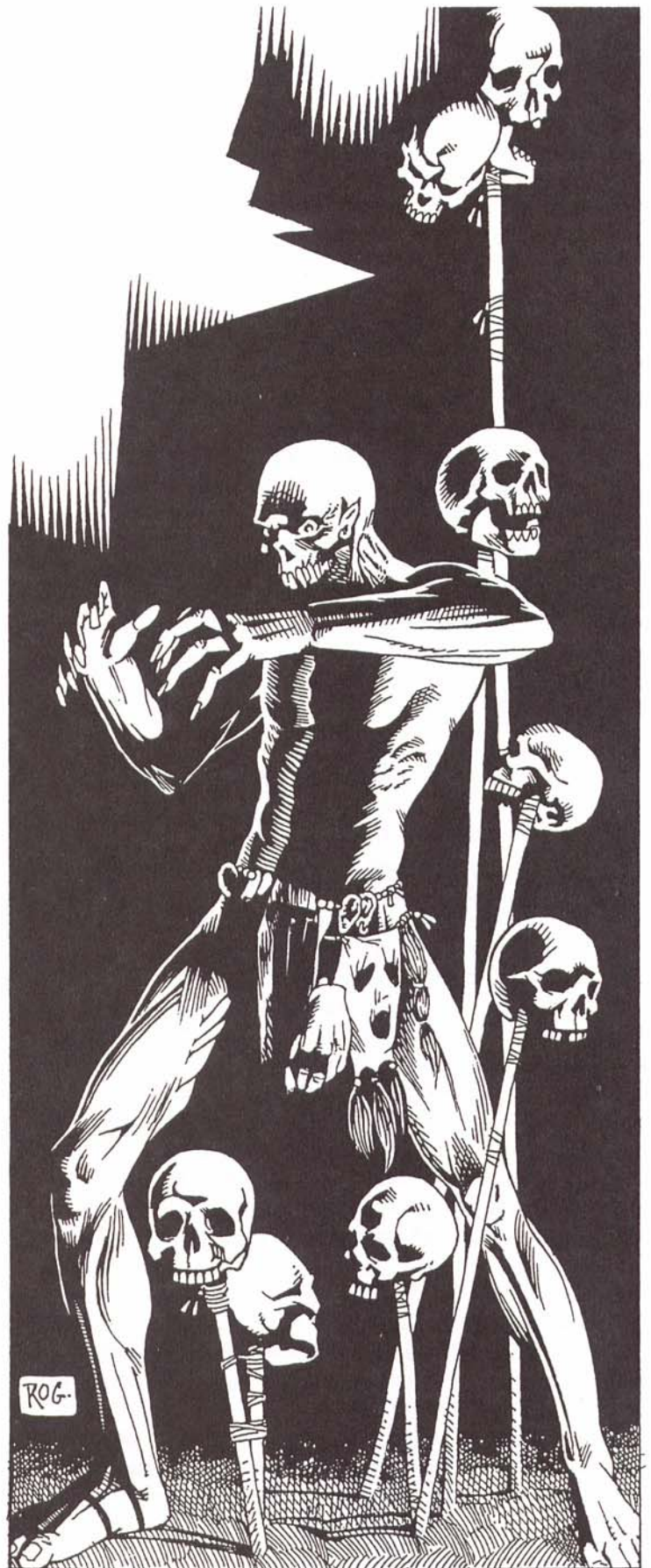

O.C.C.s and R.C.C.s of the Empire of the Sun

Listed below are some of the character classes original to the Empire of the Sun. In addition to the classes described in the following pages, other typical occupations and races include the following:

Warrior O.C.C.s: Vagabonds and Wilderness Scouts are fairly common; many of them are natives of the Free City of Arequipa, or travelers from other nations. Headhunters exist only in Arequipa. A few Totem Warriors (see *Rifts South America: One*) dwell in the jungle regions.

Magic O.C.C.s: Mystics, Warlocks and Tribal Shamans are the most common magical O.C.C.s (not counting the ones indigenous to the region). Ley line walkers and techno-wizards are much rarer; less than 5% of the total wizard population, combining the two! Other magical O.C.C.s are even less frequent.

Psionic R.C.C.s: Wild psi-stalkers, bursters and mind melters can be found in small numbers across the Empire of the Sun and other parts of South America. The Incas have decreed that psionics are not inherently good or evil, it is how their psychic powers are put to use that matters. Psychics are therefore not persecuted.

Other O.C.C.s: City rats, operators, and similar city or technological-related O.C.C.s are common in the free city of Arequipa, but rare everywhere else.

R.C.C.s: Like everywhere on Earth, D-bees (dimensional beings) brought to the planet by Rift activity are fairly common, accounting for nearly 30% of the total population. Common non-humans include feline mutants from Omagua, other mutant animals from the Achilles Republic, lizard men from the Kingdom of Lagarto, dragons and psi-stalkers. Dozens, possibly hundreds, of other D-bee races have members living in the Empire and Peru, but in very small numbers, usually less than 1,000, and often less than one hundred.

Inca Soldier O.C.C.: Soldiers are the rank and file of the Inca Armies (not to be confused with the elite *Inca Warriors*). These soldiers undergo basic training and are then sent to fight the Arkhons and protect the frontiers. They are best used as non-player characters rather than player characters. Inca Soldiers have no special bonuses, and have the following common O.C.C. skills: basic radio (+15%), one piloting skill, two piloting related skills (both at +5%), two W.P.s (including either Energy Rifle or Assault Rifle), and Hand to Hand: Basic. Related skills: nine additional skills from any category, with a +3% bonus, and seven secondary skills.

Inca Soldier Specialists: These are equivalents of the CS Elite RPA, Military Specialist and Technical Officer O.C.C.s. Use the *Rifts RPG* attributes and skills, but change the specialties and equipment to Empire of the Sun equivalents.

True Inca R.C.C. Demigods

The True Incas are transdimensional beings with superhuman powers who belong to the Pantheon of the Sun (Inca gods), led by the all-father deity *Viracocha*. They founded the Inca Empire some 800 years before the Coming of the Rifts, but they left the Earth not too long afterwards, leaving the care of the empire in the hands of human believers. True Incas are related to demigods or godlings (see *Rifts Conversion Book II: Pantheons of the Megaverse* for more information about those beings). They appear to be lesser descendants of the Inca gods, or perhaps valuable servants who were granted supernatural abilities as a reward. Like other demigods and godlings, the True Incas are very long-lived and have supernatural abilities.

Typically, True Incas are tall, athletic humanoids. They are slightly lighter-skinned than most Andes natives, but have similar facial features. It was that light-skinned quality that led to the belief that the Spanish invaders were the returning demigods. Each True Inca has a patron deity from which his or her individual powers are determined (they reflect those of the patron god). *Viracocha* Incas have great power over spirits and magic, for instance, while *Inti* Incas have powers over light and fire. The demigods dress in colorful tunics and capes, and often wear large, ornate earrings.

Most True Incas are the loyal servants of the Pantheon of the Sun. There are some who have left the Pantheon and have their own goals. A few of those are evil Incas who have utterly rejected their pantheon and now work for its enemies. Some of these renegades have become bandits, warlords and criminals. One of them, a former *Inti* Inca known as *Flame Puma*, is the leader of a large Larhold war band (see the **Larhold Threat section** for more information). Others are not necessarily evil, but have moved on to search for their own destiny. Some of these wanderers and adventurers are actually heroes who join forces with undead slayers, cosmo-knights, dragons and magicians, and travel the Megaverse righting wrongs.

The god-like True Incas in the Empire act as protectors, judges and commanders of the realm. Although they no longer serve as the rulers of the people, they are respected or feared by all. Often, True Incas are used as messengers, troubleshooters, and scouts. They typically travel in small groups; there are rarely more than four or five True Incas in any given group, and most travel by themselves or with mortal companions. Many of their missions involve dealing with the Arkhons. The invading aliens hate and fear the True Incas, so the Arkhon Spectral Hunters (advanced cybernetic soldiers) are often tasked with the destruc-

tion of these supernatural champions. Besides the High Priest of the sun, the True Incas have the most direct access to the gods of the pantheon, especially each one's patron god. Although gods do not expect to be troubled unless it is something important, they will almost always be there for their progeny.

True Inca R.C.C.

Alignment: Any, but most are good or unprincipled.

Attributes: I.Q. 3D6+4, M.E. 3D6+4, M.A. 3D6+6, P.S. 4D6+6, P.P. 3D6+5, P.E. 3D6+10, P.B. 3D6+6, Spd. 4D6+8.

Size: Average six feet (1.8 m) tall.

M.D.C.: P.E. $\times 8$, plus P.E. attribute number per additional level of experience (a True Inca with P.E. 18 would have 144 M.D.C. at level one and get 18 M.D.C. per level of experience). Additionally, any S.D.C. bonuses for physical skills count as additional M.D.C.

Horror Factor: 10 if their true nature is revealed.

P.P.E.: $2D6 \times 10 + P.E.$ attribute number, plus 15 points per level of experience if a practitioner of magic; $1D4 \times 10$ otherwise.

Average Life Span: 40,000+ years, effectively immortal.

Natural Abilities: See the invisible, regeneration ($1D4 \times 10$ M.D.C. per minute/4 melee rounds), and nightvision 200 feet. (61.0 m). Plus special powers determined by the True Inca's patron deity. The following are the most common:

Viracocha Inca (All-Father): $+1D6 \times 10$ M.D.C., $+6$ to P.S.

Magic: Knows 4 spells each from levels 1-3 at first level, plus add two new spells of the character's level or less per additional level.

Psionics: Knows 4 sensitive powers at first level, plus two sensitive or healing powers are acquired at every new level of experience.

Special Powers: Can exorcise spirits (60% plus 3% per additional level) and is immune to all forms of possession and mind control.

Inti Inca (Sun God): $+10$ M.D.C., $+2$ to P.P.

Flame/Light Powers: Can fly at up to 300 mph (480 kmph), surround himself in a nimbus of true sunlight (20 foot/6.1 m radius; vampires take half normal sunlight damage if in the area), and create an energy field with 20 M.D.C. per level of experience. The character can also fire sun-bolts ($2D6$ M.D. plus $1D6$ M.D. every two levels after the first; range: 500 feet/152 m).

Psychic Powers: Has the following Burster powers: extinguish flame and sense fire.

Pachamama Inca (Earth Mother): $+3$ to M.A. and P.E.

Healing Touch: Can restore $2D6$ M.D.C. or $3D6$ S.D.C. of hit points, six times a day at no P.P.E. cost, plus can use the psionic healing touch (at normal I.S.P. cost), and the spell heal wounds (at normal P.P.E. cost); both the spell and psionic healing restore the equivalent M.D.C. as well as hit points!

Psionic Powers: Knows 4 sensitive, 4 healing and 2 physical powers, plus can select a power from any of those categories at every additional level of experience.

Magic Powers: Knows 3 earth warlock spells each from levels 1-3, plus gains a new spell per additional level of experience (spells of the same or lower level than the character).

Illapa Inca (God of Thunder): $+2$ to P.S. and P.P.

Thunder/Air Powers: Flight (Up to Mach One), can summon storms as per the warlock spell (see *Rifts Conversion*

Book One, page 83), three times a day, and can fire lightning bolts inflicting $1D4$ M.D. per level of experience (range: 500 feet/152 m).

Magic Powers: Knows three water warlock spells each from levels 1-3, plus learns an additional two spells per level; these spells are of the same or lower level as the character.

Psionic Powers: Hydrokinesis and four psionic powers from any of the three non-super categories, plus one new power from those categories at each additional level of experience.

Experience Level: Player characters start at first or second level of experience. NPCs average $1D4+2$.

Psionic Powers: As determined above. All True Incas with psionics have the following I.S.P.: $2D4 \times 10$ plus M.E. attribute plus $2D6$ I.S.P. per level of experience.

Magic Powers: As determined above, plus add one attack/action per melee.

Combat: As per skill.

Damage: Supernatural P.S. (see *Rifts Conversion Book One*, pg. 22) or by weapon or power.

Bonuses: $+1D4$ on initiative, $+1$ to strike, parry and dodge, $+2$ to save vs magic, $+6$ to save vs horror factor.

Vulnerabilities/Penalties: None.

R.C.C. Skills:

Dragonese/Elven 98%

Quechua 98%

Spanish 98%

One Language of Choice: ($+20\%$)

Demon and Monster Lore ($+20\%$)

Basic Math ($+10\%$)

Wilderness Survival ($+15\%$)

W.P.s: Two of choice.

Hand to Hand: Expert

Hand to Hand: Expert can be changed to martial arts at the cost of one "other" skill.

R.C.C. Related Skills: Select eight other skills. Plus select two additional skills at levels three, seven, ten and fourteen. All new skills start at level one proficiency.

Communications: Cryptography and Radio: Basic only.

Domestic: Any ($+10\%$)

Electrical: None.

Espionage: Any ($+5\%$)

Mechanical: Locksmith only.

Medical: Holistic medicine only ($+5\%$)

Military: None

Physical: Any ($+5\%$ where applicable)

Pilot: Any, except robots and power armor.

Pilot Related: Navigation only.

Rogue: Any

Science: Any

Technical: Any ($+10\%$)

W.P.: Any

Wilderness: Any ($+5\%$)

Secondary Skills: The character also gets to select five secondary skills from the previous list. These are additional areas of knowledge that do not get the advantage of the bonus listed in parentheses. All secondary skills start at the base skill level. Also, skills are limited (any, only, none) as previously indicated on the list.



Alliances and Allies: Works closely alongside any member of the Inca Empire, including warriors, line makers, and rune warriors. Will also work with godlings and demigods of other pantheons of light, cosmo-knights, undead slayers, cyber-knights and other champions of good.

Weapons: True Incas are given a magical club (2D4 M.D. plus supernatural hand to hand damage) and an enchanted spear (2D6 M.D. plus supernatural hand to hand damage). Additionally, they can select one energy weapon and two normal archaic weapons.

Body Armor: Enchanted cloth armor with 90 M.D.C.

Money and Equipment: Basic survival equipment (including fishing hooks, rope, one week's rations, holistic first-aid kit, a hammock, and a tent) in a backpack, and 1D4×1000 credits in coins. Also, a True Inca in a mission for the Empire can expect to be clothed, fed and equipped at no cost in any dwelling or province of the Empire.

At third level, a True Inca still in service with the Pantheon of the Sun will be granted a holy item of choice (see the Inca Warrior for more information). An additional holy weapon will be granted at levels five, six and nine. Other weapons and equipment may be acquired over time.

Inca Warrior O.C.C.

A member of the warrior elite assigned to protecting the Incas and their Empire. The Inca Warrior is far different from the militias that make up the majority of the Imperial Armies. The warrior is provided with holy and magical weapons of great power, and trained exhaustively in the arts of war. The intensive mental and physical training, coupled with their magical equipment, makes them the match for any power armor soldier or any squad of modern infantrymen.

The warrior class is not well versed in technology; only soldiers trained in the free city of *Arequipa* learn to understand and use advanced weapons like power armor, robot vehicles and similar systems. The warriors rely on the magical powers of their talismans and weapons, along with their skills and cunning, to overcome their enemies. Inca Warriors are traditionally men, but in latter years dedicated females have been granted the same privileges and special weapons; their conduct and performance have been outstanding so far.

Inca Warriors are sometimes sent on missions alone or in small groups. These missions include scouting for enemy troops, search and destroy guerrillas and terrorists, sabotage against the Arkhons or other enemies, and espionage. Often, the warriors fight side by side with True Inca demigods, or they may lead a squad, platoon or company of regular soldiers. There are only about 2,000 elite warriors in the entire Empire of the Sun, mostly because there are no more holy weapons available to equip others.

The only shortcoming of the Warriors is that most of their training is mystical or archaic. Although they often use ultra-tech energy weapons, they know very little about vehicles, power armor or other advanced systems. As a result, they sometimes underestimate or misjudge the danger posed by those technological wonders, which has cost many a Warrior his life.

Inca Warrior O.C.C.

Alignments: Any, but usually good or unprincipled.

Attribute Requirements: M.E. 12 or higher. Physical attributes should all be at least a 10 (also see attribute bonuses).

O.C.C. Abilities and Bonuses: +1D6 to P.S. and P.E., +1D4 to P.P., +1D4×10 S.D.C. +1 to initiative, +1 to strike and parry, +2 to dodge, +2 to roll/pull punch, +2 to save vs magic, +3 to save versus psionics. All these are in addition to attribute and skill bonuses.

Magical Weapons and Talismans: These weapons make the Inca Warrior a magical juggernaut, able to face off against technological foes. All Inca Warriors are equipped with the following:

1. Holy Axe: This is a minor holy weapon with the following abilities: inflicts 4D6+6 M.D., can heal 1D8+1 S.D.C. or M.D.C. points six times a day, and glows golden when wielded against supernatural beings.

2. Amulet of Protection: An amulet that projects the *Armor of Ithan* spell at 10th level (100 M.D.C.) strength and can be activated at will, six times a day (each activation lasts 10 minutes).

3. Holy Sun Sling: A magical weapon that fires small balls of magical fire. Damage: 4D6 M.D. Range: 2000 feet (610 m).

4. Additional Holy/Magical Weapons: When going on dangerous missions, Inca Warriors are equipped with either *Nazcan Mystical Armor* or *Sun Power Armor* (see below). At sixth level, Inca Warriors still serving the Empire are given a greater holy weapon (see *Rifts Atlantis* for more information on rune and other magic weapons).

O.C.C. Skills:

Language: Quechua 98%

Two languages of choice (+25%)

Wilderness Survival (+15%)

Running

Climbing (+10%)

Demon and Monster Lore (+10%)

Power Armor Combat: Elite (*Nazca PA* or *Sun Power Armor*)

W.P. Axe (treat as W.P. Sword)

W.P. Sling (treat as Archery and Targeting)

W.P. Blunt

W.P. Energy Rifle

Hand to Hand: Expert

Hand to Hand: Expert can be changed to hand to hand: martial arts at the cost of one "other" skill.

O.C.C. Related Skills: Select eight other skills. Plus select an additional skill at levels three, five, seven, and twelve.

Communications: Any

Domestic: Any (+10%)

Electrical: None.

Espionage: Any (+5%)

Mechanical: None.

Medical: Holistic Medicine only.

Military: None.

Physical: Any

Pilot: Any

Pilot Related: Any (+5%)

Rogue: Any

Science: Any

Technical: Any (+10%)

W.P.: Any

Wilderness: Any (+10%)

Secondary Skills: The character also gets to select eight secondary skills. These are additional areas of knowledge that do not get the bonuses listed in parentheses. All skills start at the base skill level. Also, all skills are limited (any, only, none) as previously indicated on the list.

Standard Equipment: In addition to the magic/holy weapons previously described, the Inca Warrior is equipped with either an Inti-20 laser rifle or an Illapa-5 rocket rifle, an energy pistol of choice, six grenades (equivalent to Coalition grenades), and a suit of Gilded Armor (70 M.D.C.). Plus he has three sets of ordinary clothing and two sets of ceremonial, traditional clothing, a survival kit, and a radio.

Money: 1D4×1000 credits.

Cybernetics: Starts with none and rarely gets any.

Inca Sun-Priest O.C.C.

The Inca priesthood is the most prestigious organization in the Empire. To be a priest of the Pantheon of the Sun is to be a leader of the community, loved and respected by the multitude of believers. With the status and power comes a great deal of responsibility. The historical Inca priesthood enjoyed a lot more privileges and much less scrutiny. Now, however, the priests are literally living under the supervision of their gods. They are also going through a time of strife, with enemies within and without, and with thousands of fearful believers looking to their priests for leadership.

There are many types of priests in the Empire, although most believers find such distinctions irrelevant. Some priests have no magical powers and serve as administrators and scholars. Most have some degree of power, but their duties are relatively mundane, helping tend the sick, spread the teachings of the pantheon, and similar clerical activities. Others are active defenders of the faith, acting as troubleshooters sent to the farthest reaches of the Empire to help the people and to defend against supernatural threats. This last type is described here.

Itinerant priests are agents of the Pantheon. Often, they travel alongside True Incas, Inca Warriors, other defenders of the realm, champions of light and adventurers. Their duties include offering spiritual help to the distraught, healing the sick, protecting the innocent and combating evil. They are not trained in the arts of war, but some of them learn such skills later on in life, to better protect the believers. Most of their power comes from their link with the gods rather than from any special skills or combat abilities. Sometimes they even travel in secret, hiding their rank and ability to carry out their mission unhampered; this is especially true when a priest is sent beyond the borders of the great Empire, where his status may actually gain him enemies.

O.C.C. Abilities and Bonuses:

Note: In addition to the powers and abilities listed here, Inca priests can select three of the special powers listed in *Rifts Conversion Book Two: Pantheons of the Megaverse*. If the Game Master/players do not have that book, add one more spell per level of experience to make up for those abilities.

1. Spell Casting: The Inca priest can use magic and cast spells. These spells are granted by the Pantheon of the Sun, and are not learned. In fact, most Inca priests do not know much about the study and practice of sorcery. Spells cannot be learned



or purchased, only acquired through meditation every time the priest has reached a higher spiritual plateau (i.e., a new level of experience). Spells are selected from the common magic spells; priests of some specific deities can also select elemental spells (see below); elemental magic is described in the *Rifts Conversion Book One*.

At first level select a total of six spells from levels 1-2. At second level, select an additional four spells from levels 1-3. At third level, select three more spells from levels 1-4. At fourth level and beyond, select two spells equal to or lower than the caster's level of experience (i.e., spell levels 1-4 at fourth level, 1-5 at fifth, and so on).

2. P.P.E.: Through his connection to the gods, the priest is a living reservoir of mystical energy. P.P.E. is equal to 1D6×10 plus the P.E. attribute number, plus gains an additional 10 P.P.E. per level of experience. Priests can also tap into the power of ley lines and nexus points to fuel their powers.

3. Gifts of the Gods: In addition to their spell casting powers, Inca priests gain special abilities which vary depending on which god they worship. The four major gods and their special abilities are listed below:

Viracocha (the All-Father): Priests of Viracocha not only learn common magic, but can also select elemental spells from any two elements! Add two spells at level one (for a total of eight spells); these two additional spells are chosen from any one or two elements (after the choices are made, only spells from those two elements can be chosen). Add an additional elemental spell at levels two, three, six, nine and twelve. Level limitations remain the same. Also, a priest has a chance (20% +5% per additional level) of once per day calling on Viracocha for help. If the roll is successful, the priest can cast ANY one spell, of any spell level, that his god knows. Furthermore, he can cast it as if he were five levels higher! For example, a fifth level priest of Viracocha who successfully called on his god could cast any spell Viracocha knows at tenth level effectiveness.

Inti (Sun God): The True Sun Priests can learn elemental fire spells; the character will know two elemental fire spells at level one (for a total of eight spells), and will gain an additional elemental fire spell at levels three, five, seven, nine and eleven. Level limitations remain the same. Also, True Sun Priests can cast the spell globe of daylight at no P.P.E. cost, at will.

Pachamama (Earth Mother): The Priests of Pachamama can learn earth spells. Add one earth spell per level of experience; these are in addition to the normal spells described above. Also, the priests can use a healing touch which restores 1D8 hit points/S.D.C. or 1D4 M.D., as often as once every other melee round (twice per minute). The healing touch only works on others.

Illapa (God of Thunder): Devotees of Illapa can learn elemental water spells; the character will know two elemental water spells at level one (for a total of eight spells), and will gain an additional elemental water spell at levels three, five, seven, nine and eleven. Level limitations remain the same. The priests can also sense weather changes and predict the weather (34% at level one, +4% per additional level of experience), and can cast the Thunderclap spell, at no P.P.E. cost, once per minute (4 melees).

4. Other Bonuses: +1 to spell strength at levels four, eight and twelve; +1 to save vs magic at levels three, six, nine and twelve, +2 to save vs horror factor.

5. Holy Symbol: All priests are given a holy amulet of Viracocha, a religious symbol that can cast the following spells, three times a day, each at tenth level proficiency: armor of Ithan, circle of protection (superior; the symbol is used to draw the circle), and heal wounds.

No P.P.E. must be spent to activate the spells. The holy symbol will only work for the priest it was made for. If a being with hatred for the pantheon in his heart touches the holy symbol, he is burned for 3D6 M.D. of damage (this only works if the victim willingly touches the symbol; the power cannot be used as a weapon). The holy symbol can also be used to repel vampires like a cross. The symbol is made out of gold, and shaped like a ceremonial knife; the "blade" is the face and headgear of Viracocha, and the handle is his body.

6. Bond of Loyalty: The powers of the priests are conditional on their service and loyalty. Should the priest break his vows of loyalty by betraying the pantheon or the Empire of the Sun, worshipping an alien or evil god, aiding and abetting supernatural monsters (includes vampires and demons, but not D-bees or supernatural beings of non-evil alignments), refusing to help or attempt to help the needy, and similar dishonorable behavior, the god may withdraw his support. The Game Master should decide based on the priest's past performance, the (role-played) piety of the character, and other factors such as, is the priest in an important quest for a pantheon? Some gods might decide to overlook a transgression, either because the priest has rendered valuable service in the past or because he might redeem himself in a current quest. If those factors are not enough to merit mercy, the god will withdraw his/her power from the priest! This is a painful, horrible experience; the priest will feel as if his soul was being torn away from his body, a cold, wrenching experience that leaves the character feeling nauseated, weak-kneed and feverish (only one attack/action per melee, no combat bonuses, all skills at -40%). This feeling lasts for 1D4 hours.

The defrocked priest loses all his powers, bonuses and magic! Even his holy symbol will cease to function; often the symbol will melt or burn from the rage of the god! Furthermore, other priests, demigods and supernatural servants of the pantheons will know that the priest has broken his vows and betrayed the gods. This may lead to exile, public abuse, beatings and persecution in the lands of the Empire. The unfortunate character becomes a pariah, despised by all. Trying to atone for this sin is difficult but not impossible; a sufficiently devout character might be readmitted to the fold—but he or she would start at first level of experience!

Inca Sun-Priest O.C.C.

Alignment: Any, but typically good or anarchist.

Attribute Requirements: None. The priest only needs his faith and dedication. A high M.E. and M.A. are helpful but not necessary.

O.C.C. Skills:

Language and Literacy: Quechua (98%)
Language and Literacy: Dragonese/Elven (+25%)
Languages and Literacy: Two of choice (+20%)
Basic Math (+20%)
Demon and Monster Lore (+20%)
Land Navigation (+10%)
One W.P. of choice
Hand to Hand: Basic
Hand to Hand: Basic can be changed to hand to hand: expert at the cost of one "other" skill or to martial arts at the cost of two other skills.

O.C.C. Related Skills: Select eight other skills. Plus select two additional skills at levels four, eight and twelve. All new skills start at level one proficiency.

Communications: Any

Domestic: Any (+10%)

Electrical: Basic only.

Espionage: Wilderness survival only.

Mechanical: None.

Medical: Any, except cybernetics (+10%)

Military: None.

Physical: Any

Pilot: Any

Pilot Related: Navigation only.

Rogue: Any

Science: Any (+10%)

Technical: Any (+20%)

W.P.: Any

Wilderness: Any (+5%)

Secondary Skills: The character also gets to select three secondary skills from the previous list at levels one, five and ten. These are additional areas of knowledge that do not get the advantage of the bonus listed in parentheses. All secondary skills start at the base skill level. Also, skills are limited (any, only, none) as previously indicated in the list.

Standard Equipment: Holy symbol (see above), a suit of Sinchi light body armor (45 M.D.C.), traveling clothes, ceremonial robes and masks, sleeping bag, canteen, rations, and survival kit, as well as an energy weapon and an archaic weapon of choice.

Money: 3D6x100 credits.

Cybernetics: None to start. Most will avoid most cybernetics, preferring to rely entirely on their god(s).

Nazca Line Maker O.C.C.

The Line Makers are the heirs of the ancient Nazca culture. Once a proud and powerful race, most Nazcans died or fled the Earth during the fall of Atlantis, and the few survivors who stayed eventually lost most of their knowledge. In the decades following the defeat of the first Arkhon invasion, the Nazcas left on Earth were absorbed by other tribes and all but forgot their identity.

Meanwhile, the Nazcas who fled Earth traveled the Megaverse. Some of them, clamoring for revenge against the Atlanteans, spent centuries in futile wars against the transdimensional survivors from that culture. Most of them settled in small pocket dimensions, never forgetting their homeland, using their magic to observe their old world and prepare for their return there. Some Nazca sorcerers came back to Earth to help their descendants fight off the Arkhons, but they left soon thereafter. The Nazcas saw the rise of the Inca Empire, a worthy heir to their culture, but then witnessed, with dismay, the destruction of all native civilizations at the hands of Europeans. For five hundred years and more, the magician-kings continued to hide out in their pocket dimension. Sometimes they fought with other dimensional wanderers, including the Splugorth, but for the most part they have kept to themselves.

The Coming of the Rifts was everything the Nazcas had dreamed of, and more, although the return of magic was catastrophic, destroying almost every civilization on the planet. At first, the Nazcas considered settling in the returned continent of Atlantis (a fitting revenge, some mages said), but the majority decided against it, preferring to return to the high plains they had once ruled. The greatest line makers hidden away in their pocket dimensions opened large Rifts and their entire population of 10,000 line makers and 50,000 servants and bodyguards (including 5,000 Rune Warriors) returned to the Nazca plateau. In the three hundred years since then, new generations of line makers have been trained in the secret magicks of Nazca.

Line makers do not learn spells like normal sorcerers; instead, they focus their will and their psychic energy through symbols and drawings. Interestingly enough, the symbols do not even have to be sketched with writing or drawing implements. In most cases, just making the sketch in the air will produce the result. Beginners have to see the drawings to make sure that they are not making mistakes, but with experience, this physical point of focus becomes less necessary. Although the drawings are only ways to focus the will, the belief necessary to make symbols into reality requires precise exactitude in the ritual of making the symbols. Consequently, only the most experienced magicians (and those with an M.E. of 23 or higher) can dispense with physical drawing materials. In any case, it takes just as long to trace the symbols in the air as it does to draw them normally on paper or in the dirt.

Line Maker O.C.C. Abilities and Bonuses:

1. Sense ley line and ley line energy: This power is somewhat similar to the ley line walker, psi-stalker and similar sensitive. The line maker can sense and see the presence of magic. All the following abilities are automatic and do not require the expenditure of P.P.E.

Sense ley line: The line maker is able to feel whether there is a ley line within the area of his sensing abilities, 5 miles (8 km) per level of experience. The line maker can tell the exact distance from the ley line, within 3 feet (0.9 meters)! He can locate the ley line with uncanny accuracy (60%+5% per additional level of experience).

Sense rift: The character can sense the opening of a Rift within 50 miles (80 km).

Sense magic in use and see magic energy: Equal to the ley line walker (see *Rifts RPG*, p. 83).

2. Knowledge of Line Magic: Line Makers are the masters of the secrets of line magic; only they can use it to its full potential. At first level, the character knows eight common line rituals (see the Line Magic descriptions). At every level after the first, the character can select two additional drawing rituals.

Furthermore, Line Makers have a good chance to recognize and understand line drawings made by another maker (100% if the drawing is one the magician knows, 30% plus 5% per additional level of experience for drawings he has not mastered). If the line drawing was made permanent (see the Permanence ritual drawing in the line descriptions), he can use it by spending the normal P.P.E. This ability is exclusive to the Line Maker O.C.C. Other magicians can learn to use drawings, but can never make use of other mages' drawings.



At first, second and third level, the magician must actually draw the pattern to use it. This requires a roll against the Art: Line Drawing skill (see below). The amount of time it takes to do the drawing is listed under each drawing description. Any writing implement can be used (modern line makers favor markers; the ancient ones used chalk, brushes and even sticks on mud), but if the magician's hands are bound or he doesn't have a writing or drawing instrument, he cannot use his magic!

Upon reaching the fourth level of experience, the line maker can visualize the lines; usually, he will make sketching gestures with his hands, but no roll against the art skill is necessary. Restraining the magician's hands will still keep him from using the magic, regardless of his level of expertise.

3. Other Spell Magic: Although line makers do not learn magic the way other mages do, some of their line drawing rituals have similar effects as common magic spells. Additionally, line makers can learn diabolist wards if they have access to them; however, the Inca civilization has no formal contact with diabolists or any civilization that uses that style of magic, so access to any wards is determined solely by the Game Master. The spells listed below can be selected in addition to, or instead of, the new line drawing rituals; each spell counts as one ritual:

- Concealment
- Mystic alarm
- Circle of flame
- Protection Circle: Simple
- Protection Circle: Superior
- Summon Entity

4. P.P.E.: Like other practitioners of magic, the line maker can store magical energy. Total P.P.E. is equal to 2D4×10 plus the P.E. attribute number, plus 3D6 P.P.E. per level of experience. The characters can also draw from the energies of ley lines and nexus points.

5. Bonuses: +1 to save vs psionics, +1 to spell strength at levels three, seven, ten and thirteen, +1 to save vs magic at levels three, six, nine, eleven and fourteen, +4 to save vs horror factor.

Nazca Line Maker O.C.C.

Alignment: Any

Attribute Requirements: I.Q. 11 or higher. High P.E. and M.E. attributes are desirable but not mandatory.

O.C.C. Skills:

- Language: Quechua (98%)
- Language: two languages of choice (+15%)
- Basic Math (+20%)
- Art: Line Drawing (+30%)
- Astronomy (+15%)
- Demon and Monster Lore (+10%)

Hand to Hand: Basic can be selected as an "other" skill, Hand to Hand: Expert at the cost of two "other" skills, or Martial Arts (or assassin if an evil alignment) for the cost of three "other" skills.

O.C.C. Related Skills: Select nine other skills, but two must be from the technical category. Plus select an additional skill at levels three, six, eight, eleven and thirteen. All new skills start at level one proficiency.

Communications: Basic radio only.

Domestic: Any (+10%)

Electrical: None.

Espionage: Intelligence and Wilderness Survival only (+5%)

Mechanical: None.

Medical: First aid or holistic medicine only (+10%)

Military: None.

Physical: Any

Pilot: Any (+5%)

Pilot Related: Any

Rogue: Prowl only.

Science: Any (+10%)

Technical: Any (+10%)

W.P.: Any

Wilderness: Any

Secondary Skills: The character also gets to select six secondary skills from the previous list. These are additional areas of knowledge that do not get the advantage of the bonus listed in parentheses. All secondary skills start at the base skill level.

Standard Equipment: Ceremonial robes and feathered headgear, traveling clothing (2 sets), suit of Sinchi Body Armor (45 M.D.C.), backpack with survival kit, camp knife, one energy weapon of choice and 1D6 E-clips, writing/drawing implements, and one Jar of Power (see below) with 4D6 stored P.P.E. (usable only once).

Money: 2D4×1000 credits.

Cybernetics: None.

Rune Warrior O.C.C.

Rune warriors first made their appearance during the early days of the True Nazca civilization. The once primitive peoples of the Nazca plateau had used their knowledge of line making to become a powerful nation during the early years of humankind. Success attracts enemies, however, and the Nazca were beset by a race of demonic beings, the Red People. To confront this race of red-skinned giants (see the **Red People R.C.C.**), the Nazca sorcerer-kings created the rune warriors. This elite group of warriors were raised from childhood in special camps (orphans were typically selected for this life) where they were exposed to magical energies and trained in the arts of war.

The gradual exposure to magic and the application of permanent line drawings turned the rune warriors into supernatural beings. Furthermore, they were gifted with a symbiotically-linked Pattern Staff, a powerful magical weapon with dozens of carved symbols and patterns. With or without their staffs, however, rune warriors were living repositories of magical energy; line drawings allow them to store P.P.E., power magical spell effects, and perform superhuman feats. The process is somewhat similar to tattoo magic (see *Rifts Atlantis*), but it is not as painful or mind-wracking. The powers granted by the line drawings and the magical transformation are not as varied or radical. Still, the rune warriors were fearsome opponents, and they led the counterattacks that finally pushed the Red People into cavern hideouts deep within the Andes mountains. Since then, a small cadre of these warriors has been kept by the Nazcans to serve as bodyguards, agents and war leaders.

When Nazca was absorbed by the new Empire of the Sun, the Incas expanded its scope, training thousands of children and giving them the gift of power patterns. Although not as powerful as the True Incas (demigods), rune warriors are just as widely re-

spected, and their role is just as important. They often escort priests, diplomats and other important members of the Empire. The unarmored warriors, armed with strange spears and dressed in archaic cloaks and loincloths, often stir laughter and contempt

among technological societies. Rune warriors do not mind the laughter, because many an enemy has underestimated the "primitives," and paid dearly for their presumption. These warriors are also found at the forefront of battle, and patrol the most dangerous areas of the Empire. They actively combat marauding Arkhons, evil undead, guerrillas and bandits. A few champions have also been sent beyond the Empire of the Sun on missions spanning the Earth and even the Megaverse.

The new crop of Nazca warriors have been better trained in the ways of technology, but for the most part, they reject it, using it only when absolutely necessary, and far preferring to rely on their powers.

O.C.C. Abilities and Bonuses of Rune Warriors:

1. Supernatural Transformation: Rune Warriors are magically transformed into supernatural beings by the power patterns etched into their skin. As a result of this magic, the character's strength, reflexes, speed and endurance become supernatural. **Bonuses:** +8 to P.S., +4 to P.P., +8 to P.E. and +15 to Spd. The warriors become M.D.C. beings, determined by the character's P.E. number plus $1D4 \times 10$ M.D.C., plus they gain an additional $2D6$ M.D.C. per level of experience.

2. P.P.E.: Some of the patterns drawn on the skin of the rune warriors allow the characters to store magical energy and quickly regain it. **P.P.E.:** $P.E. \times 5 + 10$. Add 10 P.P.E. per level of experience. Unlike mages, however, the rune warriors cannot draw on ley lines, living beings or other sources for additional power; they are restricted to their own personal P.P.E. However, their P.P.E. recovery is linked to ley lines; used P.P.E. is regained at the rate of 6 points per hour normally, 10 per hour if within a mile (1.6 km) of a ley line, and 15 per hour if within a mile from a nexus point.

3. Magic Drawings: Power patterns are magically *drawn* (not tattooed) on the skin and can never be erased. To activate the drawings, the rune warrior must concentrate and spend the necessary P.P.E. The effects of all these symbols last one minute per level of experience. The following power patterns are given to all rune warriors:

Pattern Armor: A suit of energy armor appears around the wearer. Typically the armor has fanciful shapes, including horns, animal shapes, etc. The suit protects the wearer against hostile environments, gases and toxins, and has 200 M.D.C. **P.P.E. Cost:** 25

Pattern Sight: These geometric symbols, painted over the eyes of the warrior, can be activated to allow him to see the invisible, sense magic, sense evil and presence sense, as per the spells. **P.P.E. Cost:** 15

Power Symbol: These lines, drawn alongside the arms and torso of the warrior, enable him to raise his strength and stamina. When activated, the warrior temporarily raises his P.S. by 5 and gains an additional 50 M.D.C. **P.P.E. Cost:** 20

Speed Symbol: This pattern is drawn on the sides of the legs and lower torso. When activated, speed is raised to 110 (75 mph/110 kmph!), and kick attacks do $1D4 \times 10$ M.D.! **P.P.E. Cost:** 15

Skill Symbol: These patterns are shaped like interlocking weapons, drawn around the warrior's wrists. When activated, the warrior is at +1 to strike, parry and dodge with any weapon he is proficient with. **P.P.E. Cost:** 20



Healing Symbol: These concentric circles within rectangles are drawn on the chest of the warrior. When activated, the rune warrior regenerates damage at the supernatural rate of 1D6×10 per minute. **P.P.E. Cost:** 25

4. Pattern Staff: This powerful weapon is created during the rune warrior's initiation. A permanent line pattern is woven and linked to the warrior's life force. The result is somewhat similar to Splugorth bio-wizardry, but the staff is not a true living organism, but a construct of pure magical energy. The staff looks vaguely crystalline, with many growths, spines and carvings along its length. It has the following qualities:

M.D.C. Construct: The staff has 1D4×100+200 M.D.C. It is only damaged if an attacker deliberately targets it. Furthermore, the staff regenerates at the rate of 10 M.D.C. per hour.

Transfer Life Force: The Staff can transfer some of its life force to the wearer, to a maximum of 100 M.D.C. over a 24 hour period. This link is two-sided, however; if the staff is destroyed, the rune warrior takes 2D6×10 M.D.C.!

Energy Beam: The warrior can focus his P.P.E. and fire powerful energy beams through the staff. Damage is 1D6 M.D. per P.P.E. point spent. The blasts are +3 to strike. Range is limited to 100 feet (30.5 m) per level of experience.

5. Other Bonuses: +1 on initiative, +2 to roll with impact, add one attack per melee, and +3 to save vs horror factor.

6. Other Magic: Rune warriors have little knowledge of spell casting and magic. Their abilities are limited to the use of power patterns, so they cannot learn other types of magic. However, they can use techno-wizard or magical items.

Rune Warrior O.C.C.

Alignment: Any, but usually good or unprincipled.

Attribute Requirements: None; but see bonuses. All that's needed is a desire to fight evil, defend the innocent and/or protect the Empire.

O.C.C. Skills:

Language: Quechua

Language: Two of choice.

Basic Radio (+15%)

Basic Math (+15%)

Intelligence (+10%)

Wilderness survival (+10%)

Tracking (+10%)

W.P. Staff (treat like W.P. Sword)

Two W.P.s of choice.

Hand to Hand: Expert

Hand to Hand: Expert can be changed to Martial Arts at the cost of one "other" skill.

O.C.C. Related Skills: Select 8 other skills. Plus select an additional skill at levels three, six, eight, eleven and thirteen. All new skills start at level one proficiency.

Communications: Any (+5%)

Domestic: Any (+5%)

Electrical: None.

Espionage: Any (+10%)

Mechanical: None.

Medical: First Aid, Paramedic or Holistic Medicine only.

Military: Any.

Physical: Any (+5% where applicable)

Pilot: Any

Pilot Related: Any

Rogue: Any (+5%)

Science: Any

Technical: Any (+10%)

W.P.: Any

Wilderness: Any (+10%)

Secondary Skills: The character also gets to select three secondary skills at levels one, five and ten. These are additional areas of knowledge that do not get the bonus listed in parentheses. All secondary skills start at base skill level. Also, skills are limited (any, only, none) as previously indicated on the list.

Standard Equipment: See the Pattern Staff, above. Additionally, rune warriors are issued two energy or rocket weapons of choice (typically a pistol and a rifle), a radio, survival knife, survival kit, two sets of traveling clothes, two sets of ceremonial robes, a backpack and a first aid kit.

Armor: None. Rune warriors cannot wear sealed/environmental armor. Their line patterns are constantly emitting magical energy; under most circumstances, this presents no problems, but if encased in sealed armor, the magical energy has the chance to build up and it starts eating at the armor! Damage is 1D4 M.D.C. points every hour, taken from the armor layers; the first 10 points will unseal the armor. In any case, rune warriors prefer to rely on their magical powers.

Money: 1D6×1000 credits.

Cybernetics: None. Will not accept cybernetic enhancements under any circumstances.

Nazcan Line Magic

The mystical drawings on the Nazca plateau are but one example of the magical powers of that lost culture. The Nazcans discovered millennia ago that symbols could be made to work powerful magic; this knowledge may date as far back as the pre-historic cave paintings in Europe 30,000 years ago. The fact that many ancient South American peoples practiced cave painting may be related to this practice. The Nazcans went beyond those primitive forms of associative magic; by 10,000 BC, their culture had mastered a system of magic that bridged the gap between an object and a symbol of an object. By drawing on the rich magical fields that existed on Earth at that time, the line makers could create magical constructs of pure energy. These constructs ranged from solid energy walls and constructs to energy to animated energy creatures.

The ritual of making the drawings became the focus of the magician's will and energy. The drawing also acted as a matrix that held pure magical energy and contained it in the desired form. To some degree, each pattern acts like a miniature system of ley lines and nexus points, storing and controlling magic to produce a particular effect. Most Nazca line creations shine like neon lights, and are constructs of energy made solid. Semi-transparent and luminous, they can be easily confused for holograms

or illusions, but their power is very real. An energy jaguar's claws are just as powerful, if not more so, than a real one's.

By making the lines permanent or semi-permanent, the magician can consistently create the magic effects automatically by spending P.P.E., but without taking any time to perform the "drawing" ritual. This was one of the reasons for the elaborate Nazca pottery; the drawings on those pots could be used by line makers as the focus for their magic. The Nazca Lines of the desert plateau are large-scale examples of this technique.

The other aspect of Nazca line drawing is its connection to ley lines and nexus points. The Nazcans were among the first cultures on Earth (matched only by the Atlanteans) to recognize, sense and study the unique network of magic that controls the flow of psychic energy across the planet. In fact, it was the knowledge of *lines* of mystic energy that prompted the use of *line drawings* for ritual magic. To the Nazca wizards, ley lines are part of a "cosmic drawing" whose very pattern is life and reality. Their magic drawings are an attempt to simulate these cosmic patterns on a smaller scale. The more powerful line makers can even extend ley lines by channeling and refocusing ley line energy!

Unlike traditional magic, which is based on the spoken or written word (casting spells, reading from scrolls, etc.), line magic uses drawings. When casting a spell, the line maker draws the desired pattern; when the drawing is completed, P.P.E. flows from the mage into the pattern, fueling it. Pre-made drawings can also be used, in which case the spell effect occurs immediately after P.P.E. has been spent on it. Patterns are often drawn on jars and ceramic objects, or woven in capes, carpets, etc. Only characters with skills in weaving can inscribe patterns in clothing, although patterns can also be drawn on body armor, vehicles and other flat surfaces.

Note: Characters of other magical O.C.C.s can learn to use line drawing rituals, but the alien style of magic requires a lot of work and is very difficult to operate and understand. First of all, the characters must gain the *art* skill to learn how to draw the pattern, and they never gain the bonuses that allow true line makers to make symbols without using drawing implements (see the **Nazca Line Maker O.C.C.** for more information). Furthermore, the art of magic drawing requires a different type of discipline, focus and precision that most other magic O.C.C.s will find awkward and disorienting — only the circle making diabolist has a knack for line making magic.

At second level and above, a mage (ley line walker, mystic, temporal mage, etc.) can learn, purchase or mystically acquire a line ritual. However, the power, range and effects of the line magic/spell functions at only half the level of the magician! For example, a fourth level ley line walker who learned a line ritual would only cast it at second level strength; a seventh level one would only cast it at third level of power (round down when halving levels). Only line makers, who have spent their lives studying these rituals, can use their powers at full strength (and are themselves penalized in that they cannot cast most regular spells).

Also note that line making magic is comparatively rare. It is a unique type of magic that was developed in one particular region of the world. Even dimension spanning Nazca mages are hesitant to share their secrets. Consequently, this form of magic is most common to the Empire of the Sun, Peru in general, and extremely rare beyond the South American continent.

Common Line Drawings

All line drawing rituals have three elements: drawing the design, the time it takes to draw (divided into minutes for long rituals or melee attacks/actions for short ones; approximately 3-7 seconds; most practitioners of magic have two actions per melee), and the P.P.E. cost. Range and area are typically determined by the drawing itself; magic effects with range are detailed in the ritual description. Unless otherwise indicated, spells that negatively affect the subject of a mystical attack can be resisted with a successful saving throw against magic.

Alphabetical list of Nazca Line Drawings

Close Rift (200+ P.P.E.)
Draught of Health (8 P.P.E.)
Earthquake Pattern (50-200 P.P.E.)
Energy Jar (20 P.P.E.)
Entryway (15 P.P.E.)
Feast Sign (6 P.P.E.)
Fire Lines (8 P.P.E.)
Greater Animal Drawing (18-72 P.P.E.)
Healing Pattern (20 P.P.E.)
Lesser Animal Drawing (6-24 P.P.E.)
Line Blast (30 P.P.E.)
Monster Drawing (25-120 P.P.E.)
Pattern Armor (45 P.P.E.)
Pattern of Control (30+ P.P.E.)
Pattern Wall (8+ P.P.E.)
Pattern of Wounding (40 P.P.E.)
Power Symbol (20 P.P.E.)
Symbol of Pain (8 P.P.E.)
Wield Lightning (25 P.P.E.)

Secret Line Magic

Create Ley Line Storm (800 P.P.E.)
Extend Ley Line (200+ P.P.E.)
Make Ley Line (300+ P.P.E.)
Open Rift (2000+ P.P.E.)
Permanency (Special)
Warrior Pattern (40 P.P.E.)
Activating Nazca Lines of the Plateau (Special)

Close Rift

Drawing Description: Two sets of arrows forming the sides of a triangle, aiming towards the rift.

Time to Draw: Two melee actions.

P.P.E. Cost: 200 plus 2 P.P.E. from the character's permanent P.P.E. base!

This ritual works just like the Close Rift spell (see the *Rifts RPG*, page 189), except that the ritual form with line magic will only take 1D6 minutes.

Draught of Health

Drawing Description: A circle within a square, with a snake twisting out of each corner of the square.

Time to Draw: Three melee actions.

P.P.E. Cost: 8

The drawing is done on the outside of a canteen, cup, glass or other drinking vessel. Traditionally, it was permanently inscribed on a ceramic jar. When the P.P.E. is expended, the drink-

ing vessel is filled with a glowing red liquid. Drinking this liquid will heal 1D8+2 hit points or S.D.C., or 1D4+1 M.D.C. for supernatural beings. The liquid must be drunk within 24 hours, at which point it will vanish.

Feast Sign

Drawing Description: A basket or jar, overflowing with food-stuff.

Time to Draw: Three melee actions.

P.P.E. Cost: 6

The drawing is typically made on a jar, basket or other food container. When the ritual is complete, six glowing, wafer-like, thin squares of magical energy appear in the container. These wafers will provide sustenance and nourishment for any living thing that eats to survive. Each spell casting provides enough to satisfy a human for three meals (2 wafers per meal; 6 wafers are created). Larger humanoids, or beings with higher metabolisms, will need to consume more to sustain themselves.

The energy wafers have a tingling "taste," with a faint scent of ozone. Although not filling, the energy creations will quell hunger and make people feel energized and revitalized in 1D4 minutes. No digestion process is needed, as the energy automatically bonds with the body. Even psi-stalkers will gain nourishment from these energy wafers; the equivalent of one P.P.E. point per each wafer (psi-stalkers need 50-100 P.P.E. per week).

Note: These wafers do nothing for thirst, vitamin deficiencies, or other nutritional needs (minerals, etc.); they only provide energy. Living exclusively on the energy blocks will have detrimental effects on humans after 1D4+2 weeks (dizziness, vision impairment, pangs of hunger even after eating the wafers, and other afflictions as a result of malnourishment — the body's way of letting one know it needs proper food and vitamins). If combined with vitamin supplements and/or normal foodstuffs, however, no negative effects apply.

Lesser Animal Drawing (Animal Type)

Drawing Description: A geometric, two-dimensional, line representation of a specific animal, at 1/5 to 1/20th scale.

Time to Draw: Small animals (cat-sized or smaller): 1 melee action. Medium sized (dog-sized to man-sized): 2 melee actions. Large (up to horse-sized): 3 melee actions. Huge animals (buffalo, elephants, etc.): 4 melee actions/one minute.

P.P.E. Cost: 6 for small, 10 for medium-sized, 15 for large and 24 for huge types.

Duration: The pattern is powered by the spell for 10 minutes plus one minute per level of experience.

This pattern creates an energy animal with S.D.C. and powers equivalent to the real life version, but look like they are made of glowing energy. The creature is a construct that will obey every command of its maker, and it has maximum S.D.C. and hit points common to that type of animal (see the *Palladium Book of Monsters & Animals* for stats of approximately 200 different animals).

Note: Each time the ritual is learned, the line maker knows how to create ONE type of energy animal. The ritual can be learned multiple times, each time learning the pattern of a new animal *type* or animal category. The specific animals must be

known to the line maker either from pictures or in real life, consequently, the animals and insects drawn most often reflect those indigenous to South America. Animal types/categories are as follows:

African Giants (elephant, rhinoceros, giraffe, etc.)
Apes (chimpanzees, gorilla, etc.)
Anteaters (all kinds, plus armadillos and tree sloths)
Arachnid (spiders and scorpions of all kind)
Bear (all types)
Birds: song types/small
Birds of prey/large
Bovine: cattle (ox, bull, cow, buffalo)
Bovine: deer (all kinds, plus sheep and lama)
Canine (dogs, wolves, etc.)
Feline (cats, jaguar, ocelot, puma, mountain lion, etc.)
Fish: General (all kinds)
Fish: Predators (sharks, barracuda, etc.)
Horse (all kinds, pony, donkey, mule, etc.)
Insects (wasp, bee, fly, etc.)
Lemurs (all kinds)
Monkeys (all kinds)
Mustelids (badger, weasel, skunk, etc.)
Pigs (wild boar, warthog, pig, etc.)
Sea mammals of the land and water (seals, otters, walrus)
Reptile: Lizards (lizards, caiman, alligators, etc.)
Reptile: Snakes (pythons, and all kinds)
Rodents (capybara, mice, rats, squirrels, etc.)

Some brief Animal Descriptions:

Alligator & Caiman: The same size and behavior as the real animals (but look like they are made of glowing energy). 40 hit points and 30 S.D.C. Bite inflicts 2D6+2 S.D.C. damage, slashing and tearing hands do 1D4 damage. Two attacks per melee. +3 to strike, +1 to parry and +2 to dodge. Average speed is 9 on land and 14 in water/swimming. Nightvision 40 feet (12.2 m), swim 90%, hold breath for up to four minutes, prowl in/under water 68%, excellent sense of smell and hearing, track by smell 55%.

Ape: Chimpanzee: The same size and behavior as the real animal. 48 hit points and 40 S.D.C. Bite inflicts 2D4 S.D.C. damage, slashing and tearing hands do 2D4+3 damage. Three attacks per melee. +3 to strike, +2 to parry and dodge, and can use simple weapons such as clubs, knives, swords, etc. Average spd is 10. Nightvision 15 feet (4.6 m), climb 60%, leap up to 10 feet (3 m).

Ape: Gorilla: The same size and behavior as the real animal. 80 hit points and 80 S.D.C. Bite inflicts 2D4 S.D.C. damage, slashing and tearing hands do 2D6+6 damage. Four attacks per melee. +3 to strike, +3 to parry, +1 to dodge, and can use simple weapons such as clubs, knives, swords, etc. Average spd is 12. Nightvision 15 feet (4.6 m), climb 40%, and prowl 40%.

Baboon: The same size and behavior as the real animal. 48 hit points and 10 S.D.C. Bite inflicts 2D6+3 S.D.C. damage, slashing and tearing hands do 2D4+2 damage. Three attacks per melee. +3 to strike, +2 to parry and dodge. Average spd is 12. Nightvision 40 feet (12.2 m), exceptional vision and hearing, track by smell 45%.

Badger & Wolverine: The same size and behavior as the real animals. 30 hit points and 10 S.D.C. Bite or slashing claws

do 1D6+2 S.D.C. damage. Three attacks per melee. +1 to strike and parry, and +3 to dodge. Average spd is 12. Nightvision 50 ft (15.2 m), track by smell 65%, and dig 5 feet (1.5 m) per minute.

Bear: Black and Brown: The same size and behavior as a real bear. 66 hit points, 80 S.D.C. Bite does 1D8+2 S.D.C. damage, slashing claws 2D6+6 damage, pouncing/ram does 1D6+4 and has a 1-50% chance of knocking its opponent down (victim loses initiative and one melee attack), but counts as two attacks. Three attacks per melee. +2 to strike and parry, +1 to dodge. Average spd is 22 but can run in bursts of speed at 30 mph (48 km) for up to 15 minutes.

Bear: Grizzly: The same size and behavior as a real bear. 120 hit points, 80 S.D.C. Bite does 1D8+6 S.D.C. damage, slashing claws 2D6+8 damage, pouncing/ram does 2D6+4 and has a 1-62% chance of knocking its opponent down (victim loses initiative and one melee attack), but counts as two attacks. Four attacks per melee. +2 to strike and parry, +1 to dodge. Average spd is 16 but can run in bursts of speed up to 20 mph (32 km) for up to 15 minutes.

Bird: Hawk or Falcon: The same size and behavior as the real animals. 16 hit points and no S.D.C. Bite 1D6 S.D.C. damage, slashing claws inflict 1D4+2 damage, and a diving claw attack 2D4+2 damage, but counts as two attacks. Three attacks per melee, +2 to strike and parry and +3 to dodge. Average speed flying is 50, about 35 mph (56 km). Nightvision 300 feet (91.5 m), exceptional vision and hearing, and track by smell 65%.

Bird: Eagle: The same size and behavior as the real animal. 24 hit points and 10 S.D.C. Bite 2D4 S.D.C. damage, slashing claws inflict 2D6+4 damage, and a diving claw attack 4D6+4 damage, but counts as two attacks. Four attacks per melee, +2 to strike and parry and +3 to dodge. Average speed flying is 50, about 35 mph (56 km), but can attain a speed of 75 mph (120 km) and maintain that speed for an hour. Nightvision 400 feet (122 m), exceptional vision and hearing, and track by smell 46%.

Boar or Wild Pig: The same size and behavior as the real animals. 40 hit points and 40 S.D.C. Bite/slashing tusks does 1D8+2 S.D.C. damage, head butt does 1D6+2, ram does 2D6+4 and has a 1-55% chance of knocking its opponent down (victim loses initiative and one melee attack), but counts as two attacks. Three attacks per melee. +1 to strike, and +2 to dodge. Average spd is 22 but can run in bursts of speed at 35 mph (56 km) for up to 30 minutes.

Canine: Fox, Coyote, Jackal, or Small Dogs: The same size and behavior as the real animals. 24 hit points, 10 S.D.C. Bite does 1D6+4 S.D.C. damage, slashing claws do 1D4 damage. Three attacks per melee. +1 to strike and parry, +4 to dodge. Average spd is 50, about 35 mph (56 km) and can run at that speed for 1D6 hours. Track by smell 60%, swim 50%, keen vision and hearing.

Canine: Wolf or Large Dogs: The same size and behavior as the real animals. 48 hit points, 40 S.D.C. Bite does 2D6+8 S.D.C. damage, slashing claws 1D4 damage, three attacks per melee. +3 to strike, +1 to parry, +6 to dodge. Average spd is 50, about 35 mph (56 km) and can run at that speed for 2D4 hours. Track by smell 85%, swim 65%, prowl 50%, keen vision and hearing, and nightvision 30 ft (9 m).

Elephant: The same size and behavior as the real animal. It can be ridden by the Line Maker who created it. 90 hit points

and 80 S.D.C. Three attacks per melee, tusk inflicts 2D6+6 S.D.C. damage, strike from trunk 1D6, leg kick/stomp 3D6+6 damage, head butt does 3D6+6, and a ramming charge and trample inflicts 6D6+6 damage and has an 80% likelihood of knocking opponents weighing less than 1000 lbs to the ground, causing them to lose one melee attack and initiative (counts as two attacks). Average spd is 10, about five mph (8 km), but can run as fast as 35 mph (56 km) for 30 minutes. Keen hearing and sense of smell, good vision, nightvision 40 ft (12.2 m), swim 90% and has prehensile trunk.

Feline: African Lion: The same size and behavior as the real animal. 52 hit points, 80 S.D.C. Bite does 2D4 S.D.C. damage, slashing claws 2D6+6 damage, four attacks per melee. +3 to strike and parry, +4 to dodge. Average spd is 22, about 15 mph (24 km), but can run in bursts at a speed of 25 mph (40 km) for 1D4 minutes. Track by smell 70%, swim 50%, prowl 70%, climb 30%, leap up to 15 feet high (4.6 m) and 20 feet long (6 m), keen vision and hearing, and nightvision 60 ft (18.3 m).

Feline: Bobcat, Lynx, Ocelot, Jaguar, Mountain Lion: The same size and behavior as the real animals. 42 hit points, 40 S.D.C. Bite does 1D6 S.D.C. damage, slashing claws 2D4+3 damage, four attacks per melee. +3 to strike and parry, +4 to dodge. Average spd is 22, about 15 mph (24 km), but can run in bursts at a speed of 30 mph (48 km) for 1D4 minutes. Swim 44%, prowl 86%, climb 90%, leap up to 20 feet high (6 m) and 20 feet long (6 m), keen vision and hearing, and nightvision 60 ft (18.3 m).

Feline: Leopard & Panther: The same size and behavior as the real animals. 48 hit points, 40 S.D.C. Bite does 1D6 S.D.C. damage, slashing claws 2D4+3 damage, four attacks per melee. +3 to strike and parry, +4 to dodge. Average spd is 22, about 15 mph (24 km), but can run in bursts at a speed of 35 mph (56 km) for 1D4 minutes. Track by smell 50%, swim 80%, prowl 90%, climb 75%, leap up to 20 feet high (6 m) and 40 feet across (12.2 m), keen vision and hearing, and nightvision 60 ft (18.3 m).

Feline: Tiger: The same size and behavior as the real animal. 68 hit points, 80 S.D.C. Bite does 2D6 S.D.C. damage, slashing claws 2D6+8 damage, four attacks per melee. +3 to strike and parry, +4 to dodge. Average spd is 22, about 15 mph (24 km), but can run in burst at a speed of 35 mph (56 km) for 1D4 minutes. Track by smell 50%, swim 80%, prowl 70%, climb 50%, leap up to 20 feet high (6 m) and 25 feet long (7.6 m), keen vision and hearing, and nightvision 60 ft (18.3 m).

Ferret, Mink, or Martin: The same size and behavior as the real animals. 12 hit points and no S.D.C. Bite and slashing claws inflict 1D4 S.D.C. damage. Three attacks per melee, +1 to strike and parry and +4 to dodge. Average spd is 10. Nightvision 40 feet (12.2 m), exceptional vision and hearing, track by smell 65%, climb 50%, prowl 65%, and swim 70%.

Horse: The same size and behavior as the real animal. It can be ridden by the Line Maker who created it. 48 hit points and 80 S.D.C. Three attacks per melee, bite inflicts 1D4 S.D.C. damage, front leg kick 2D6 damage, hind leg kick 4D6 damage, charging head butt does 2D4+10 and has an 80% likelihood of knocking opponents weighing less than 300 lbs to the ground, causing them to lose one melee attack and initiative (counts as two attacks). Average spd is 33, about 22 mph (36 km), but can run as fast as 45 mph (72 km) for 1D4 hours. Can also leap up to six feet high (1.8 m) and 12 feet long (3.6 m), keen hearing, and swim 50%.

Monkey: The same size and behavior as the real animal. 32 hit points and 10 S.D.C. Bite and slashing/tearing hands inflict 1D6+1 S.D.C. damage. Three attacks per melee, +3 to strike and parry and +5 to dodge. Average spd is 12. Nightvision 25 feet (7.6 m), exceptional vision and hearing, climb 95%, acrobatics 95%, leap 8 ft high (2.4 m) and 20 feet (6 m) across in trees, prehensile tail.

Rhinoceros: The same size and behavior as the real animal. It can be ridden by the Line Maker who created it. 84 hit points and 80 S.D.C. Two attacks per melee, jab with horn inflicts 2D6+4 S.D.C. damage, leg kick/stomp 3D6+4 damage, head butt with horn does 3D6+4, and a ramming charge and trample inflicts 4D6+6 damage and has an 80% likelihood of knocking opponents weighing less than 1000 lbs to the ground, causing them to lose one melee attack and initiative (counts as two attacks). Average spd is 14, about seven mph (11 km), but can run as fast as 30 mph (48 km) for 12 minutes. Keen hearing and sense of smell, poor vision, and swim 40%.

Scorpion: The same size as a common scorpion, it behaves as a living scorpion would, its sting is poisonous. Three attacks per melee, +2 to strike and dodge, spd 8, and can climb most surfaces except glass or highly polished metal.

Spider (non-poisonous): One to three inches (76 mm maximum) in diameter. Bite does one point of damage. Two attacks per melee, spd 10, and can climb most surfaces except glass or highly polished metal.

Spider (poisonous): Three inches (76 mm) in diameter. Bite does one point of damage plus 4D6 damage (roll to save vs poison—a successful save means no damage). Three attacks per melee, spd 12, and can climb most surfaces except glass or highly polished metal.

Snake (poisonous): About four to six feet long (1.2 to 1.8 m). Moves and behaves as a normal snake. Bite inflicts 1D4 S.D.C. damage and releases a poison that causes an additional 4D6 damage (roll to save vs poison—no damage if save is good). Two attacks per melee. +3 to strike and dodge, spd 7.

Wasp or Bee: The same size as the common insects, it behaves as a living bee or wasp. Its sting is painful, causing one S.D.C. point of damage per every two stings. Two attacks per melee, +2 to strike and dodge, spd walking 8, spd flying 37 (25 mph/40 km) and can climb most surfaces except glass or highly polished metal.

Greater Animal Drawing

Drawing Description: Fundamentally the same as Lesser Animal Drawing, but surrounded in a circle within a triangle.

Time to Draw: Three melee actions for a small creature, four for a medium-sized one, five for a large animal, and six for a huge one (see Lesser Animal Drawing for size determination).

P.P.E. Cost: 18 for a small creature, 30 for medium sized, 45 for large and 72 for huge ones.

Duration: Greater Animal Drawings last five minutes plus 1 minute per level of experience of the maker.

This pattern creates an energy animal with M.D.C. equal to its S.D.C., and equivalent mega-damage from its attacks; bite, claws, sting, etc. For example, an animal that inflicts 2D6 S.D.C./hit points from its bite, now does 2D6 M.D.C.!

Monster Drawing

Drawing Description: A fanciful pattern, usually with horns, clawed hands or tentacles, and sinister looking faces or of known monster species.

Time to Draw: Three melee actions for a small monster (less than 50 M.D.C.), four melees for a medium-sized monster (less than 150 M.D.C.), six melees for a large monster (less than 400 M.D.C.) and eight melees for a huge monster (500-1,000 M.D.C.).

P.P.E. Cost: 25 for a small monster, 50 for a medium-sized creature, 75 for a large one and 120 for a huge monster.

Duration: One minute per level of the maker.

These magic drawings create an energy monster with maximum M.D.C. and power. Only non-intelligent monsters can be created through this ritual. The construct will obey its maker and fight his enemies to the death. Nazca sorcerers use the creatures as bodyguards, mounts, and guardians. Once summoned, the monster will exist for one minute per level of the caster.

Note: Each monster species has an individual pattern that must be learned separately; so, for example, a line maker could have Monster Drawing: Pegasus and Monster Drawing: Fury Beetle. Each monster pattern counts as a specific line ritual. Most creatures from the *Rifts Conversion Book One, Rifts Atlantis, Monsters & Animals* and other sourcebooks are known to the Nazca, and they have line patterns for each of them.

Earthquake Pattern

Drawing Description: A double line with many complex geometric symbols in the middle, forming a triangle with three equal sides. There are three sizes; 5 foot (1.5 m), 10 foot (3.0 m), and 30 feet (9.1 m) long.

Time to Draw: 10 or 30 minutes for the two smaller ones, one hour for the largest ones.

P.P.E. Cost: 50, 100 or 200

These patterns can send impulses along ley lines to cause tremors or even full-fledged earthquakes. The same pattern can also prevent earthquakes from happening in an area. The smallest (5 ft/1.5 m) pattern affects a 50 foot (15.2 m) area up to one mile (1.6 km) away (the line maker must know or be able to see the area affected). The larger one affects a 200 foot (61.0 m) area up to ten miles (16 km) away, and the most powerful one affects a 600 foot (183 m) area up to 20 miles away (32 km). **Note:** The duration of the tremors is one minute per level of the maker.

The initial earthquake strength is relatively low (2.0 Richter); each minute after the first increases the severity by a full point on the Richter Scale; at levels 4-6, most buildings (those not built to withstand earthquakes or made of energy, including most S.D.C. structures) may collapse; level 9 earthquakes are the most powerful possible, and they will destroy almost anything in the epicenter (one-tenth of the overall area affected) and severely damage everything else, toppling all S.D.C. structures and damaging mega-damage ones (each structure loses half its M.D.C.). **Note:** During an earthquake, vehicles are shaken and control will be lost (including robot vehicles). The passengers inside are tossed around the vehicle, taking 1D4 S.D.C. damage every melee round/15 seconds if buckled into their seats, 4D6 S.D.C. damage if not. Furthermore, vehicular control is extremely difficult: -40% on the piloting skill for even the most basic maneu-

vers, -60% on stunts, and an additional -20% if speeding faster than 30 mph (48 kmph). The greatest danger to those in vehicles, robots, and walking in the streets are buildings toppling down on them and crushing or burying them alive! There is also some risk of fissures opening up in front or underneath them and swallowing them into the earth! Those on foot will be knocked to the ground and crawl or stumble at one-tenth their normal speed.

The pattern can also be used to help protect *against* earthquakes. The area affected is the same, but the duration is equal to the earthquake's, and the severity level of the tremors is reduced by 2 levels on the Richter Scale per level of the caster. For example, if an earthquake with a severity level of 5.6 struck an area protected by a second level magician, the severity would be reduced by four levels, to 1.6. A third level magician would drop the severity by six levels, meaning that while the earth shook all around, the area protected would suffer no ill effects whatsoever.

Energy Jar

Drawing Description: An intricate interlacing geometric pattern, typically drawn or painted on a jar or drinking vessel.

Time to Draw: 5 minutes (20 melee rounds).

P.P.E. Cost: 20

Can only be drawn at a ley line or nexus point. The pattern acts as an energy matrix which can store 2D6 P.P.E. per level of the caster inside the container. This energy can be kept inside the container until needed, but it is completely used up whenever the energy is released, whether the character wants to use it all or not. The energy can be used by *any* practitioner of magic. The container has to be at least the size of a canteen; a mage could expect to carry no more than 4-6 of these containers (in addition to other equipment) without being laden down and cumbersome. If the character has seven or more containers, the following penalties apply: reduce speed by 10% and initiative and parry and dodge rolls by two points.

Note: Energy Jars are for sale in the Empire of the Sun and in areas that trade with the Empire, such as New Babylon. Cost for these jars is typically 50 to 100 credits per P.P.E. point stored.

Entryway

Drawing Description: A doorway with crisscrossing diagonal lines is drawn on a wall or other surface.

Time to Draw: 2 melee actions.

P.P.E. Cost: 15

When activated, the pattern creates a doorway or opening on any non-living material. This can be a wall, fence, roof of a vehicle, etc. The maximum thickness of material that can be penetrated with this ritual is three feet (0.9 m). The area affected gets a save versus magic, at +3 if the material is an M.D.C. alloy. The ritual also does not affect energy force fields, magic walls/barriers, or living materials like a tree or human.

Fire Lines

Drawing Description: A serrated line surrounded by triangles.

Time to Draw: One melee round per 3 feet (0.9 m) of length.

P.P.E. Cost: 8 P.P.E. per 3 foot (0.9 m) section.

The line maker must draw the line on the ground. Like all other line patterns, once drawn, it can be activated at will. The pattern causes walls of greenish flame to shoot up ten feet (3.0 m) into the air wherever the lines are activated. Anything crossing the wall will suffer 6D6 M.D. energy damage.

Healing Pattern (Minor)

Drawing Description: A geometric human figure is drawn on the ground or on a bed (permanent patterns are often woven on blankets).

Time to Draw: Five minutes (20 melee rounds)

P.P.E. Cost: 20

The person to be healed must lay down on the pattern. When the spell is activated, magical energy surrounds the subject, healing 1D6×10 S.D.C. or hit points (or 1D4×10 M.D.C.) and curing any natural disease, infection or ailment (but not the effect of a curse or other magic). Minor crippling injuries, including broken bones, concussions and torn ligaments, will also be healed, but only if the subject is brought to full hit points and S.D.C. strength. The patient who continues to lay on the pattern will gain an additional 3D6 S.D.C. (or 2D6 M.D.C.) every hour he remains there, until he regains his full health/hit points/S.D.C. **Note:** The pattern will remain active for one hour for every level of experience of the caster.

Line Blast

Drawing Description: A snake in a square in a triangle.

Time to Draw: One melee attack.

P.P.E. Cost: 30 P.P.E.

Saving Throw: Special; can only be dodged, and the dodge roll must be 16 or higher.

This pattern can only be drawn on the ground within a mile (1.6 km) of a ley line or 2 miles (3.2 km) from a nexus point. Its power feeds off the ambient energy near the ley lines rather than on the power of the spell caster. When activated, it creates an arcing crackle of energy that inflicts 3D6 M.D. plus 1D6 M.D. per level of the caster on the target (range 300 feet/91.4 m). Once activated, the caster can use the line blasts for 4 melee rounds at level one, plus one additional melee round per level of experience. Each energy attack counts as one melee attack/action. The line maker must stay within 20 feet (6.1 m) of the line drawing to be able to use its power.

Drawing the line on the ground counts as one melee attack; once it is drawn it can be used at any time by simply spending P.P.E. energy — giving a Line Maker time to prepare is very dangerous. Also, it can be woven onto a carpet or blanket, ready to be activated whenever it is rolled on the ground (must still be near a ley line and the P.P.E. must be spent, however).

Pattern Armor

Drawing Description: Depicts a jaguar-headed warrior with a club and a spear, surrounded by snakes.

Time to Draw: 2 melee actions.

P.P.E. Cost: 45

The symbol can be drawn on a wall or armor, or woven into clothing. When activated, a neon-red suit of semi-transparent armor surrounds the caster or the subject of the line drawing (such armor can be used by characters other than the line maker, but this must be indicated in the drawing). This energy armor protects with 100 M.D.C. Furthermore, as long as the energy armor surrounds the wearer, it transforms his strength into supernatural P.S. (see *Rifts Conversion Book One*, page 22, for damage details)! The armor and its powers last for two minutes (8 melee rounds) per level of the line maker.

Pattern of Control

Drawing Description: Varies from the instructions made in the pattern, but are usually a pictogram symbolizing the circumstances or events needed to trigger the pattern. Any line maker seeing the pattern has +15% to his basic skill to recognize the pattern and the instructions it has set.

Time to Draw: 5 to 10 minutes depending on the complexity.

P.P.E. Cost: 30; does not count the P.P.E. cost of any pattern activated by this ritual.

This line drawing enables the magician to delay the triggering of another line ritual drawing until some event or circumstance has occurred. For example, a line maker could make a monster drawing (peryton) and add a Pattern of Control specifying that the monster will only appear if a stranger enters the chamber where both symbols are drawn. Or a symbol of agony will strike anybody opening the chest where the two drawings are made. When conducting the ritual, the P.P.E. for both the activated ritual and the pattern of control must be spent right there and then. The pattern of control will hold the P.P.E. of both drawings in the pictogram for one week per level of experience. If the two line drawings are within a mile (1.6 km) of a ley line or ley line nexus, duration is extended to one month per level of experience!

Pattern Wall

Drawing Description: Lines are drawn on the ground; the pattern determines the height, thickness, and roofing, if any, of the walls.

Time to Draw: Two melee actions per 6 foot x 6 foot (1.8 m) section of wall.

P.P.E. Cost: 8 per 6x6 foot (1.8 x 1.8 m) section.

This is the basic spell that enabled the Nazcans to build their energy buildings and cities. When activated, a wall of shining red, green, blue or yellow light (character's choice) appears as a sheet of energy and can be used like self-connecting building panels. If two walls are made at right angles to each other, or as a square/box, a roof can be made to cover it at no extra cost. Details like walls or windows can also be selected by the specific patterns of the line drawn.

Each 6x6 foot (1.8x1.8 m) section of wall has 200 M.D.C. By spending more power (at least an additional 8 P.P.E.), the line maker can extend the wall, and ultimately make an entire house or building, tower, etc. The walls each last one hour normally, but if placed within a mile of a ley line, they last eight hours, and if built on a ley line they will last 24 hours, and 48 hour at a nexus! The secret permanency power must be used to create a permanent structure.

Pattern of Wounding

Drawing Description: Small drawings of spears and arrows, made on a weapon's blade or hilt.

Time to Draw: One hour

P.P.E. Cost: 40

Note: Only one weapon can be enchanted per ritual.

This enchantment surrounds an archaic weapon with magical energy. The most common weapons used are clubs, spears, swords and axes. When activated, the weapons will do M.D. damage equal to triple the weapon's normal damage! For example, a long sword that normally inflicts 1D8 or 2D4 S.D.C. now inflicts 3D8 or 4D6 M.D.!

Once activated, the weapon will be surrounded by magical energy for one day per level of experience of the line maker. Only the creator of the line magic can power such weapons, but they can be used by anybody. However, if the line maker is killed or put into a coma, the weapon reverts to normal (unless permanency has been applied). Each weapon so empowered requires a separate ritual. **Note:** Some weapons are permanently enchanted; this requires the Permanence symbol (and a permanent P.P.E. sacrifice of 4 points). Such magic weapons are very rare and expensive; sold only at Nazca enclaves, for as much as 30,000+ credits.

Power Symbol

Drawing Description: A mace and a spear crossed together, drawn on the skin or armor, or woven into clothing.

Time to Draw: One melee action.

P.P.E. Cost: 20

Activating this pattern raises the P.S. of the subject by 6 (or to a minimum of 20, whichever is greater), and makes it supernatural (see *Rifts Conversion Book One*, page 22). The symbol also creates a skin-tight protective field around the character, protecting him with 20 M.D.C. +5 M.D.C. per level of the ritual maker. As long as the field is active, S.D.C. characters can punch or kick M.D.C. structures without any risks and inflict M.D. like a supernatural creature. If the field M.D.C. is depleted, however, the character still has supernatural strength, but punching any hard material will inflict damage to their "fragile" bodies. When without their magic armor, each punch or kick against a mega-damage being or structure causes the character to suffer 2 S.D.C. points for every M.D. point he inflicts.

Symbol of Pain

Drawing Description: A circle with four intersecting triangles touching it.

Time to Draw: One melee action if used in combat; one minute (four melees) per 3 foot area otherwise.

P.P.E. Cost: 8

Saving Throw: 16 or higher.

This pattern can be used in two ways. In combat, the line maker can make the drawing on the floor or a wall (or, if fourth level or higher, sketch it in the air) and point to the victim to inflict mystic agony (*range* is 30 feet/9.1 m plus 10 feet/3.0 m per level of experience). If the victim fails to save vs magic, he takes 1D6 S.D.C./hit points (or 2D4 M.D.C. if a supernatural being) and is racked by pain for 1D4 rounds. During that time, he cannot use magic and psionics (cannot focus his thoughts) and attacks/melee actions are reduced to one! During that period he can parry and dodge, but at -2! A successful save means no damage, pain or penalties.

In the alternative, the line maker can use the drawn symbol as an area effect attack (maximum area affected is equal to 3 feet/0.9 meters per level of the caster), which is then activated whenever somebody enters the area.

Wield Lightning

Drawing Description: Two zig-zagging snakes.

Time to Draw: Two melee actions if drawn on skin/clothing/armor; two melee actions per 3 foot (0.9 m) area if drawn as an area effect magic. An additional person can be granted lightning powers for every 3 feet (0.9 m) after the first.

P.P.E. Cost: 25

Duration: One melee round per level of the line maker.

The pattern can be drawn on skin or clothing, or on the ground. In the first two cases, the person on whom the pattern is drawn gains the power to shoot lightning bolts, inflicting 2D4 M.D. plus 1D4 M.D. per level of the line maker (range: 1000 feet/305 m). The spell subject is also immune to electricity and electrical attacks, and all other fire and energy attacks do half damage.

If drawn as an area effect magic, every person in the area when the ritual is activated will be able to cast lightning bolts (same damage and range)!

Secret Line Drawings

These line drawings are not commonly taught to beginning line makers. Advanced adepts (6th level and higher) who have performed a valuable service for the city of Nazca or the Inca Empire could, if they so request, be rewarded with one of these rituals. Magicians who do not specialize in line making are *never* taught these powers (an individual teacher might be persuaded to do otherwise, but very rarely).

Create Ley Line Storm

Drawing Description: Six snakes twisted like lightning bolts, each coming from the corner of a hexagon, with a circle in the middle. Drawn on the ground, or woven into a carpet.

Time to Draw: One hour (ceremonial magic only).

P.P.E. Cost: 800

This drawing can only be used within one mile (1.6 km) of a ley line, or two miles (3.2 km) from a nexus point. When activated, a devastating ley line storm (see *Rifts Atlantis* or *Rifts Underseas*) opens up to one mile away from the place the symbol was drawn. The ley line storm causes massive damage, twists reality and brings havoc on the area. The symbol is only used in times of war. The storm lasts for 5 minutes per level of experience. Once started, it is difficult to stop/cancel this magic (5% chance per level of experience).

Extend Ley Line

Drawing Description: A straight line with symbols of power on both sides.

Time to Draw: Two hours per 100 foot (30.5 m) stretch (minimum).

P.P.E. Cost: 200 per 100 foot (30.5 m) stretch, plus 1D4 P.P.E. from the character's permanent base.

This powerful line ritual extends the length of a ley line! In ancient times, teams of Nazca line makers were able to extend natural ley lines by hundreds of miles, creating dozens of new nexus points. This is a difficult and draining ritual, the magical equivalent of building a river canal, and it has a price in permanent P.P.E. lost. The other risk is that the interference with the Earth's natural field can have disastrous consequences. Whenever this ritual is successfully completed, there is a 1% chance that either a Rift or a ley line storm (50% chance of either; see *Rifts Atlantis* for information about ley line storms) will be opened. This chance is raised to 3% if the ritual is begun at noon

or midnight, 6% during the Vernal or Autumnal Equinox, 10% during the Summer and Winter Solstice, 12% during a lunar eclipse and 20% during a solar eclipse.

Unlike many other line rituals, this one is permanent, as is Make Ley Line, below.

Make Ley Line

Drawing Description: A straight line with symbols of power on each side.

Time to Draw: One day

P.P.E. Cost: 300, plus 1D6 from the caster's permanent P.P.E. base!

This closely guarded ritual is only taught to the grand masters of the Nazcas (8th level or higher), and is used very carefully, because tampering with such forces always has negative consequences. The ritual consists of drawing a straight line for 100 feet (30.5 m), and then concentrating P.P.E. on it and trying to reshape the Earth's magical fields to power this new ley line. The Earth gets a saving throw (this is always a ritual), at +3 to save. On a successful save, the magician loses the P.P.E., including the permanent loss, and does not make a new ley line. Even on a success there is danger; a ley line storm or a Rift may appear; use the guidelines given for Extend Ley Line, above, but at double the percentages!

Open Rift

Drawing Description: An elliptical pattern surrounded by power symbols, drawn on the epicenter of a nexus point.

Time to Draw: Two hours.

P.P.E. Cost: 2,000 plus 1D6 from the caster's permanent P.P.E. base.

This massive ritual will open a Rift into another world! The Rift will remain open for 3D6 minutes. It can lead to a world the line maker has personally visited (88% chance the Rift will lead there), a world he has studied carefully for years (66%), a world he has heard of (40%), or a random place (the Game Master decides what is at the other side of the Rift), or roll on the following table. Use this table also if the attempt to go to a specific world failed:

01-10% Netherworld: The Rift opens to one of the hell dimensions; they can be, at the Game Master's discretion: Dyval, Hades, or Tartarus (see the *Rifts Conversion Books: One or Two*); the characters may be attacked by demons or devils (15% chance as soon as the Rift is opened, 20% chance every day the characters venture into this realm).

11-20% Divine Realms: The Rift leads to one of the home dimensions of a pantheon (see *Rifts Conversion Book: Two Pantheons of the Megaverse* for more information about the pantheons and the entities that dwell within). The gods and/or their servants may be amused at the intrusion, or may react violently to this "invasion."

21-30% Wormwood: The Rift opens to the demon-ridden dimension of Wormwood (see the *Rifts Dimension Book One: Wormwood* for more information). The characters are at risk of being attacked on sight by the inhabitants of that world, good or evil. This is a world at war where anybody can be assumed to be an enemy.

31-40% Phase World/The Three Galaxies: The Rift leads to the fabulous planet *Phase World* (most likely to the under-

ground catacombs of Center, the largest city in the Megaverse) or to one of the hundreds of worlds of the Three Galaxies. There, the characters will have to deal with cosmic heroes and villains, pirates, and monsters. Phase World and the Three Galaxies are described in the *Rifts Dimension Book Two: Phase World*.

41-50% The Xiticix Homeworld: The dimensional opening connects Earth to the alien homeworld of the Xiticix insectoids (see the *Rifts RPG*, page 253). The alien insectoids will attack anyone on sight!

51-60% Space Shift (Minor): The Rift opens up somewhere else on Earth, 1D6×100 miles (160 to 960 km) in a random direction. If this leads to sea, there is a 25% chance that the Rift opens underwater — and that thousands of gallons of water come crashing down on the caster and anybody standing in front of the Rift!

61-70% Space Shift (Major): The Rift opens up somewhere else on Earth, but very far from the characters. Select or roll randomly (this table assumes the characters opened the Rift in South America; if that is not the case, replace South America for the area in which the dimensional portal was opened): 01-20% Japan; 21-30% Central America (Yucatan or Mexico), 31-40% North American Mid-West, 41-50% North American West, 51-60% England, 61-70% NGR (or Europe), 71-80% Atlantis, 81-90% Africa or 91-00 China or Australia. Where exactly in that region, and what reception the characters receive upon arrival, is up to the Game Master.

71-80% Time Shift (Minor): The characters do not travel in space, but in time. Those crossing the Rift will find themselves back to where they started, but 3D6×10 hours will have passed! The characters suffer no ill effects.

81-90% Time Shift (Greater): As above, but 1D6×10 days have passed and can be the past or future!

91-00% Other: The characters appear in a completely different dimension, time or place — maybe the world of another RPG, or 20th Century Earth, or the Nightlands (see the *Nightspawn RPG*) or any realm or time the Game Master cares to use.

Additionally, the standard chances/risks of an entity, monster or random creature emerging from the Rift apply.

Permanency

Drawing Description: A square drawn around another pattern, with a triangle at each corner.

Time to Draw: Twice as long as the line drawing affected.

P.P.E. Cost: Varies; the character making the drawings and conducting the ritual must first create and activate a different ritual that he wants to make permanent. The permanency magic is then performed at the P.P.E. cost of one-tenth the first spell, but this P.P.E. cost is taken from the PERMANENT P.P.E. base of the line maker and is lost forever!

Makes a drawing's magic permanent until the drawing is destroyed. Requires a sacrifice of P.P.E. equal to 1/10 the P.P.E. spent on the creation to be made permanent. The powers of the rune warriors are an example of permanency symbols.

Warrior Pattern

Drawing Description: A man-sized drawing of a warrior with snakes instead of hair.

Time to Draw: Three melee actions.

P.P.E. Cost: 40

The warrior pattern summons an energy entity with I.Q. 10 (alignment anarchist or aberrant) and gives it physical form in the shape of an energy humanoid wielding a club and a spear. The warrior has 200 M.D.C., is +2 to strike, +4 to parry and dodge, and inflicts 3D6 M.D. with his club or 4D6 M.D. with his spear. The construct can be given verbal instructions, and will fight until its M.D.C. is depleted, at which time the entity will leave this plane of existence.

The Secrets of the Nazca Lines

Many modern archaeologists, UFOlogists, and scientists have pondered the mystery of the Nazca lines. Why would a primitive people build huge drawings whose patterns could only be seen from the air? Dozens of different theories claiming that the lines were anything from ancient airstrips meant for extraterrestrial visitors, to ceremonial drawings meant for balloon-riding priests, to simple ritual centers aimed at invisible gods. The truth, however, was far different. The Nazca lines were indeed meant for alien visitors, but not as airstrips or welcome signals. They were weapons, a magical defense grid that tapped the power of ley lines to destroy an invading armada; specifically the Arkhons.

The line network used the energies once applied to creating the magic walls and buildings to fire beams of devastating energy. The giant drawings also came to life as gigantic energy beings, able to destroy spaceships and crush robots. When they were activated, they lit up the sky for a thousand miles (1600 km) and smashed the proud Arkhon fleet.

Today, the drawings are under the care of the Empire of the Sun — Nazca line makers and their Inca partners. The power the lines use is such that they can only be activated briefly without risking overload, the death of the line makers activating them, or the temporary or even permanent draining of the ley lines which power the line drawings.

The Super Nexus Point: A super-powerful Nexus point is located on the Nazca Plateau. This is the place where dozens of ley lines were extended to intersect at a single point. The area's ley line energy is so strong the lines can be seen with the naked eye as glowing blue walls. Rifts open up regularly, but a permanent team of Nazcan line makers are on watch to ensure that no monsters or dangers emerge there. The Super Nexus also supplies much of the power needed to power the giant drawings and line grids.

Using the Great Nazca Lines

Access to the Nazca lines is restricted by the Empire of the Sun, but the plateau is so big that it is impossible to patrol the entire area, even by the gods and their godlings. Arkhon teams have tried to destroy the drawings using explosives, but have failed every time. Magicians, renegade line makers, and other adventurers have sometimes managed to bypass the roving Inca patrols and reach the lines. On two occasions, evil line makers managed to activate one of the animal drawings and used it for their own nefarious purposes.

All line drawings are placed over ley lines, and the line makers who want to activate them can draw on that power. Furthermore, the power pattern makes it easier to draw energy to use for this purpose; when activating any of the great drawings of the Nazca Lines, the magician gains an additional 10 P.P.E. per level of experience. This is counterbalanced by the fact that trying to draw power from the ley line for any other purpose is more difficult. Reduce available ley line energy by 20% when the energy is used for other spells; this applies to a one mile/1.6 km area around the drawing.

The Nazca Energy Beings in Combat: These energy entities are nearly invincible in combat. Only spaceships or large armies can stop these constructs, and even then the outcome is in doubt. Even ultra-powerful beings like gods or alien intelligences would not take fighting these creatures lightly. The constructs are immune to illusions and most spell effects such as pain, carpet of adhesion and similar powers. The spell *impervious to energy* protects its user against such attacks as lightning bolts and light beams, but is ineffective against the creatures' physical attacks, such as bites and punches. The entities are also immune to all forms of mind control, possession and charms. Only brute force, and immense power can destroy them.

Killing or subduing the person controlling the drawing is a much easier tactic. Typically, the line maker is surrounded by bodyguards and followers while he is in the trance that enables him to control the energy beings, plus he can direct the energy constructs to come to his defense. Furthermore, the link also protects him from any mind-altering spells, but not other common magic effects. If the character is knocked unconscious or killed, the energy construct carries out the last orders it had been given for 1D6 melee rounds, and then vanishes.

The Hummingbirds

Size: 150 to 900 feet (45.7 to 274.3 m)

These stylized hummingbirds are drawn in the middle of three ley lines, and can be brought to life by triggering the ancient power matrix they represent. Any line maker or group of line makers can activate a hummingbird by spending 1,200 P.P.E.; the magician can draw on the power of the ley line to do so.

Activating the pattern brings to life a giant energy creature, that looks like a hummingbird. The energy constructs have 3,500, 7,000 and 10,000 M.D.C., respectively. Each takes half damage from all non-magical weapons, regenerates at the rate of 1D4×10 M.D.C. per melee round, and can strike with its beak, inflicting 4D6×10 M.D. to small and medium-sized objects (less than 30 feet/9.1 m tall) and 2D6×100 M.D. to large objects like ships, starships, buildings, etc.

Combat Bonuses: Three attacks per melee, +4 to strike, -2 to dodge. The bird can fly through the air at an incredible Mach 6, and in space it can reach Mach 12 (twelve times the speed of sound). **Special Power:** By beating its wings at supersonic speed, the hummingbird can create debilitating vibrations within a 300 foot (91.4 m) area! Everybody (friend of foe) in the area has to make a save vs lethal poison or be stunned (lose initiative and one melee per attack) for 1D4 rounds.

Once activated, the hummingbird will obey the mental commands of its creator. The line maker or leader of the ceremonial group who summoned the hummingbird goes into a trance, un-

able to move or act while he controls the creature. The creature will last for one hour per level of experience of the caster.

The Lizard

Size: Over 600 feet (183 m) long.

The Lizard is a symbol of rain and fertility; the Nazcans had used it before as a tool of rainmaking, similar to the Tree of Life (see below). When it was used against the Arkhon, however, the line makers altered the pattern to create a devastating weapon of war. Activating the lizard costs 1,200 P.P.E. The giant energy creature has 12,000 M.D.C.; its bite automatically swallows anything smaller than 40 feet (12.2 m) tall (the act of being swallowed inflicts 2D4×10 M.D.) and spits them out when the lizard uses his breath attack (see below). Against larger objects, the bite does 2D6×100 M.D.! Its tail attack inflicts 2D6×10 M.D. on small (less than 40 feet/12.2 m tall) targets, or 3D6×100 M.D. on large targets.

Combat Bonuses: Three attacks per melee, +3 to strike, cannot dodge.

Special Powers:

Breath Attack: Once every other melee round, the lizard can release winds of beyond hurricane force; over 500 mph (800 kmph), nearly the speed of sound! This devastating windstorm will knock down robots and tanks, blow away human sized creatures for 1D6×100 feet (30.5 to 183 m), and inflict 4D6 M.D. to anything in the blast radius of the breath attack (100 foot/30.5 m area!). This attack only works in an atmosphere.

Teleport: The lizard can teleport up to 100 miles away (160 km) on the Earth's surface, and thousands of miles if teleporting into space. Activating this power requires an additional expenditure of 100 P.P.E. The lizard cannot carry passengers.

The Monkey

Size: 150 feet (45.7 m)

This stylized monkey with a long, snaking tail is one of the most powerful Nazca symbols. It is also the most draining one to draw, always requiring a permanent expenditure of P.P.E.! Activating the line drawing costs 2,000 P.P.E. plus a permanent loss of 1D4 P.P.E. This loss affects all living beings (P.P.E. donors) involved in the ritual! If P.P.E. is reduced to 0 or below in this way, the person dies. This influx of power creates a giant energy being with 25,000 M.D.C. Its punch does 4D6×10 M.D. to small (less than 30 feet/9.1 m tall) objects, and 3D6×100 M.D. to larger ones. Its tail does the same amount of damage, plus it can snake around large vehicles or buildings and squeeze them, inflicting 1D4×100 M.D. every round. Furthermore, once per melee the monkey can fire energy bolts from its eyes, inflicting 2D4×100 M.D. (small vehicles and robots who dodge the beam's main cone suffer only 2D6×10 M.D.). **Range:** 4000 feet (1220 m).

Combat Bonuses: Five attacks per melee, +4 to strike, cannot dodge. **Teleport:** The monkey can teleport up to 100 miles away (160 km) on the Earth's surface, and thousands of miles if teleporting into space. Activating this power requires an additional expenditure of 100 P.P.E., however. The monkey cannot carry passengers.

The Spider

Size: 120 feet (365 m)

This drawing creates a giant flying spider, able, among other things, to ensnare enemies with energy webs. It costs 1,000 P.P.E. to activate this drawing. The spider has 10,000 M.D.C. Its bite does 5D6×10 M.D.C.

Combat Bonuses: Four attacks per melee, +4 to strike.

Special Power: Energy Webs: The Spider can “spin” energy webs that ensnare and consume the targets. Each web attack covers an area of 60 feet (18.3 m)! Webbing can be fired with a range of 4000 feet (1200 m). Dodging is possible, but at -6. If snared, the victims are trapped until they can break loose (possible only for those with robotics or supernatural P.S. of 30 or higher; takes 1D6 melee rounds) or if they can inflict 100 M.D.C. on the web section. Meanwhile, the ensnared victims suffer 1D4×10 M.D. at the end of every melee round if they are M.D.C. beings/or materials, or 1D4×10 S.D.C. points otherwise (armor is consumed first, followed by flesh and bones). Ensnared aircraft will crash unless the pilot makes a piloting roll at -30%. Large starships will only take damage, unless covered with multiple webbings.

Flight: The spider can fly at speeds of up to Mach 2 in an atmosphere, and Mach 5 in space.

The Tree of Life

Size: 300 feet (91.4 m)

This was an older line drawing, originally used for bringing rain and other peaceful purposes, but at the time of the invasion it was redesigned to use its power against the Incas’ ancient enemies. It appears that this tree is related to the Millennium Trees found in Europe, Africa and Asia, although such trees do not exist in America, or it might be connected to the fabulous Tree of Life of innumerable legends. When activated, a massive tree of energy appears to rise up into the sky and disappear from view (30,000 M.D.C.). This activation costs 2,500 P.P.E. Once activated, the tree can change weather conditions anywhere within an area of 100 miles (160 km). Storms and hurricanes can be directed to hit enemy formations and vehicles. By spending another 100 P.P.E., the line makers can also cause the tree to trigger ley line storms!

Combat Bonuses: Can generate energy blasts inflicting 2D6×10 M.D. six times per melee round, at +4 to strike. **Range:** One mile (1.6 km). No other combat bonuses apply.

The Energy Line System

Size: hundreds of miles of lines, scattered over a 500 square mile (1295 sq. km) area.

This is the mysterious grid of lines, some of which extend up to five miles (8 km) in length, and sometimes drawn up in strange geometric patterns. About half of these lines trace ley lines, and are often the result of extending a ley line. The others are actually a giant version of the **Line Blast ritual** (see above). Activating these giant symbols costs 400 P.P.E. per outlet, and releases a blast that inflicts 2D4×100 M.D.! These blasts can hit only target airborne objects, but they have incredible range, able to hit targets in orbit! Small objects, such as power armor and fighter aircraft, can dodge these blasts on a roll of 9 or higher; spaceships and other large flying objects do not get a dodge!

The Pantheon of the Sun

The Pantheon of the Sun is an ancient and once powerful assemblage of deities, worshipped on several dozen worlds across the Megaverse. Viracocha and Inti, the main deities of this pantheon, are ancient beings who “walked between the worlds” before humans arose on Earth. Originally, Viracocha was a being of pure energy, as strange and inhuman as an alien intelligence. While that is still his true shape, Viracocha has learned to adopt a more humanoid aspect to better interact with other beings. Inti followed suit, but he continues to be surrounded by an energy aura that has led to his identification with the sun (and other stars in other worlds). Unlike most alien intelligences, however, the two gods had a genuine love and respect for all living beings. In those early days, the two gods formed alliances with beings who shared their goals and created the Pantheon of the Sun. These allies included the elemental deities Pachamama and Illapa and many other gods, as well as thousands of godlings and tens of thousands of demigods. For eons, these gods protected many worlds from the depredations of the Splugorth, vampires and other dangers.

Misfortune can befall the most powerful beings, however, and the gods of the Sun were no exception. First, the largest world under their control fell to **The Mechanoids**. Then, they tried to establish themselves on Earth at a time when the mystic energies of the planet were low and erratic, and finally, they lost the worship of the Inca Empire at the worst possible moment, fighting against an invasion of their dimensional realm at the hands of the minions of Ahriman (see *Rifts Conversion Book Two: Pantheons of the Megaverse*). The Pantheon was cast down, and the gods were forced into stasis to survive the catastrophe.

With the Coming of the Rifts, the pantheon has been revived, and they are now establishing themselves again on Earth. The gods still look back at the times when they were champions of entire planets, and find their still weak hold in South America to be small and confining. This is their last chance for glory and power. If the new Inca Empire falls, so do they. Consequently, they plan on spending the next few centuries strengthening and expanding that nation.

Viracocha, the All-Father

Little is known of the origin of this powerful being. He first appeared, with his brother (or son?) Inti, during a chaotic period of the Megaverse, an apocalyptic war called **The Shattering**. Beings of evil related to the Horsemen of the Apocalypse (see *Rifts Africa*), literally smashed whole planets with their powers. The Old Gods, deities now long forgotten by all but the most ancient living beings in the Megaverse, were all destroyed fighting The Shatters of Worlds. Viracocha and Inti were members of a new generation of deities who had to come to the rescue of the



infinite worlds. With their help, The Shatterers were destroyed, or perhaps only imprisoned. Some rumors (circulating only among the oldest gods) claim that Viracocha was himself a Shatterer who turned against his former peers. This seems difficult to believe, since Viracocha has always been known as a defender of the Megaverse.

The god's true body is a shining orb of pure dimensional energy. When dealing with humanoid beings, however, he usually takes on the form of a tall man with glowing yellow eyes. The god's features and body were originally Caucasian, but now he has reshaped his humanoid body to more closely resemble a native of the Andes. He dresses in traditional Inca vestments, but in battle wears a suit of complex and stylized body armor and wields two energy swords. Most of the god's powers relate to dimensional energies; Viracocha can unleash ley line storms, close and open Rifts, and manipulate magical fields. Additionally, he wields a vast number of magical abilities and powers. Once, he was one of the most powerful beings in the Megaverse. Now he is a shadow of his former self, but still as dedicated as always.

Alignment: Principled

M.D.C.: 15,000 (75,000 in the city of Cuzco). At the height of his power, the god had 150,000 M.D.C.!

Attributes: I.Q. 28, M.E. 30, M.A. 22, P.S. 45 (supernatural), P.P. 26, P.E. 25, P.B. 20 (not applicable in energy form), Spd. 40 (200 in energy form).

Disposition: Viracocha is friendly but somewhat reclusive and distant toward others. When he looks at somebody, he appears to be able to see right into the soul of the person, know-

ing his thoughts and emotions (see psionic powers, below). He has little time for idle chatter, but he will listen to people who need help, even if it is for emotional troubles. People of evil and anarchist alignments anger him, with the exception of some aberrant characters with rigid codes of honor. He will not strike without provocation even if faced with evil beings, unless they are alien intelligences, vampires or other inherently evil creatures.

Horror Factor: 15 (awe)

Level of Experience: Equivalent to a 20th level ley line walker and shifter.

Natural Abilities: See the invisible and in total darkness (range: 2000 feet/610 m), bio-regeneration 1D4×100 M.D.C. per minute, immune to normal heat and cold, and takes half damage from mega-damage energy attacks. Healing touch restores 1D6×10 S.D.C. or M.D.C. Immune to all forms of mind control or charms, and can exorcise minor spirits and demons at will (no savings throw; major demons can save vs ritual magic, at -4 to save, to resist the exorcism).

Dimensional Powers: By spending 100 P.P.E., Viracocha can close a Rift (same as the spell, but there is no saving throw and no permanent P.P.E. expenditure!). With 200 P.P.E., Viracocha can open a Rift to any dimension he has visited (which are many), and keep it open for an hour. While the Rift is open, the god can deny entrance to anything or anybody trying to cross over (gods and major entities/intelligences can resist this by making a saving throw vs ritual magic at -5 to save!).

Ley Line Storms: The god can start or stop a ley line storm (see *Rifts Atlantis*, *Rifts England* or *Rifts Underseas* for more information). This action costs 150 P.P.E.

Dimensional Blasts: Viracocha can fire bolts of pure cosmic energy. These bolts are +4 to strike and inflict 1D4×10 M.D. to supernatural beings and mega-damage materials, and 5D6 S.D.C. to humans and non-supernatural creatures. The bolts can hit anything within his line of sight! Additionally, those hit by the beams must roll on the following table:

01-20% Lucked Out! No additional effects.

21-35% Dimensional Wrenching: The victim is pulled in several directions at once, including fourth-dimensional vectors! As a result, the character is nearly pulled inside out, suffering an additional 4D6 M.D. or S.D.C., plus he is at -4 to strike, parry and dodge for 1D4 melee rounds.

36-50% Temporal Distortion: Age. The target ages 2D4×10 years! If the character is aged near the normal life span of his race, he loses half his melee actions, all combat bonuses, and reduces his P.S., P.B. and P.E. by 25%! If he is taken past the normal life span of the race, he is down to one melee attack/action, has no bonuses and an additional penalty of -2 on all combat actions. Furthermore, the ancient character will collapse from exhaustion after 1D6 melees of combat! This aging effect is temporary and will disappear in 1D4 hours. Beings of races with long life spans will typically be unaffected by this power, as will gods and alien intelligences. Cyborgs are still affected, although their physical abilities are not altered.

51-60% Temporal Distortion: Youth. As above, but the character becomes 5D6 years younger! For humans, no major effects are felt unless the regression takes them to age 13 or less. Children will not be able to use the weapons, armor and equip-

ment they once had. Combat bonuses are all lost, and they lose half their attacks. If reduced to an age of 5 to 1, they are unable to use any skills or fight in combat. If reduced to less than one year of age, the character is temporarily turned into a newborn, completely helpless! Any cybernetic or bionic implants temporarily disappear when regressed to an early age. This effect lasts 1D4 melee rounds.

61-75% Temporal Shift: The character jumps 2D6 melee rounds into the future! It appears that the character disappeared (or was disintegrated) by the blast, but at the allotted time he will return to the exact same spot. If another object is sharing the space, both take 1D4×10 M.D. or S.D.C. damage as they push each other away.

76-90% Spatial Shift: The target is teleported 4D6×10 feet (12.2 m to 73 m) in a random direction (roll 1D4, with 1 being north and going clockwise). If another object is sharing the space, both take 1D4×10 M.D. or S.D.C. damage as they push each other away. Note that nobody, including Viracocha, will know whether the character has jumped in time or space unless they can see where the character reappeared.

91-00% Spatial and Temporal Shift: Combines both effects, with the same results. The character will appear in the new place at the allotted time. As in the two examples above, he will appear to have been disintegrated.

Optional 00: If 00 is rolled, roll again. If the second roll is 91-00, the victim is teleported to a different dimension! Game Masters should use this only if such an event would be appropriate for his campaign and the situation.

O.C.C. Skills of Note: Magically knows all languages, literate in Dragonese/Elven, Spanish, Quechua, and American. Plus demon and monster lore 98%, faerie lore 98%, detect ambush and concealment 98%, and W.P. sword, W.P. shield and W.P. archery and targeting.

Combat abilities: Equal to hand to hand: martial arts plus special bonuses.

Attacks Per Melee Round: Seven

Damage: As per supernatural P.S. While in energy form, it can create pseudopods (tentacles) that inflict normal punch damage.

Bonuses (all): +5 on initiative, +8 to strike, +11 to parry and dodge, +6 to roll/pull punch, +6 save vs magic, +10 to save vs horror factor.

Magical Knowledge: Knows all spells from levels 1-15; equal to a 20th level ley line walker.

P.P.E.: 10,000 (100,000 when he was at his peak).

Psonian Powers: Has all healing and sensitive powers and empathic transmission, group mind block and mind block auto-defense; equal to a 15th level psychic.

I.S.P.: 1,000

Vulnerabilities/Penalties: Takes triple damage from rune swords of evil alignment.

Alliances and Allies: In addition to the other gods of the pantheon, Viracocha has had dealings with the gods Zurvan, Ra and Brahma (see *Rifts Conversion Book Two: Pantheons of the Megaverse*) and other gods of light.

Weapons: Two energy swords, similar to psi-swords, spring to his hands whenever he wills it. The energy blades inflict 1D6×10+10 M.D. in addition to normal hand to hand damage!

Body Armor: Enchanted plate armor, highly stylized. 2,000 M.D.C.

Money: As the titular head of the Inca Empire, Viracocha has access to literally billions of credits' worth of cash, weapons and vehicles.

Inti, the Sun God

Inti is somehow related to Viracocha; it is unknown whether he is the son or brother of the god, or simply a member of the same species, clan or race. Like Viracocha, Inti is an energy being that typically appears as a glowing ball of blinding light, which explains the god's identification with the sun. Even his human guise glows with unnatural brilliance, making it difficult to look at the god directly. Inti never wears any clothing, and appears like a human body made of pure energy. His powers appear to be light and energy-related, and he lacks most of Viracocha's dimensional abilities.

The sun god shares Viracocha's desire to defend the Megaverse from those who would conquer, despoil or destroy it. His deepest hatred is reserved for creatures of the dark and night, including vampires. There are rumors that the deity once did battle with a group of god-like beings known as the *Nightlords* in a mysterious, shadowy dimension. Inti supposedly lost the encounter and barely escaped with his life, leaving behind over a hundred dead True Incas (demigods). The god has sworn revenge and is trying to find a way to return to that dark plane of existence. He wants to wait until he is once again at the peak of his powers.

This desire to regain his powers may lead to danger, however, because Inti is pressing for an expansion of the Empire of the Sun to gain more followers. This would be started with missionaries and heroic champions to win the hearts and minds of outsiders, and might be followed by the conquest of surrounding areas (military or otherwise). Although the god does not want to forcibly convert others, in his desire to become a more powerful force of good, he is beginning to overlook the ethical implications of what he is proposing. Inti is also growing more and more violent towards the Arkhons, and his proposed solutions to the "alien problem" are getting extremely bloodthirsty. Viracocha is worried that this might cause his ancient comrade to fall from grace.

Alignment: Scrupulous with unprincipled or anarchist leanings.
M.D.C.: 10,000 (50,000 in Cuzco). At the peak of his power, he had 100,000 M.D.C.

Attributes: I.Q. 22, M.E. 26, M.A. 21, P.S. 35, P.P. 24, P.E. 27, P.B. 19 (not applicable in energy form), Spd. 60/200 in energy form.

Disposition: Inti is less even-tempered than his brother, and has been known to fly into a rage if sufficiently provoked. Acts of injustice and savagery (like an Arkhon massacre) can enrage the god into taking action. Once, he personally followed and killed every member of an Arkhon patrol that bombed a hospital, causing over two hundred deaths. At the same time, he is beginning to be tempted by his desire for power. The god might be tricked to commit evil or reckless acts to gain power or to destroy an enemy.

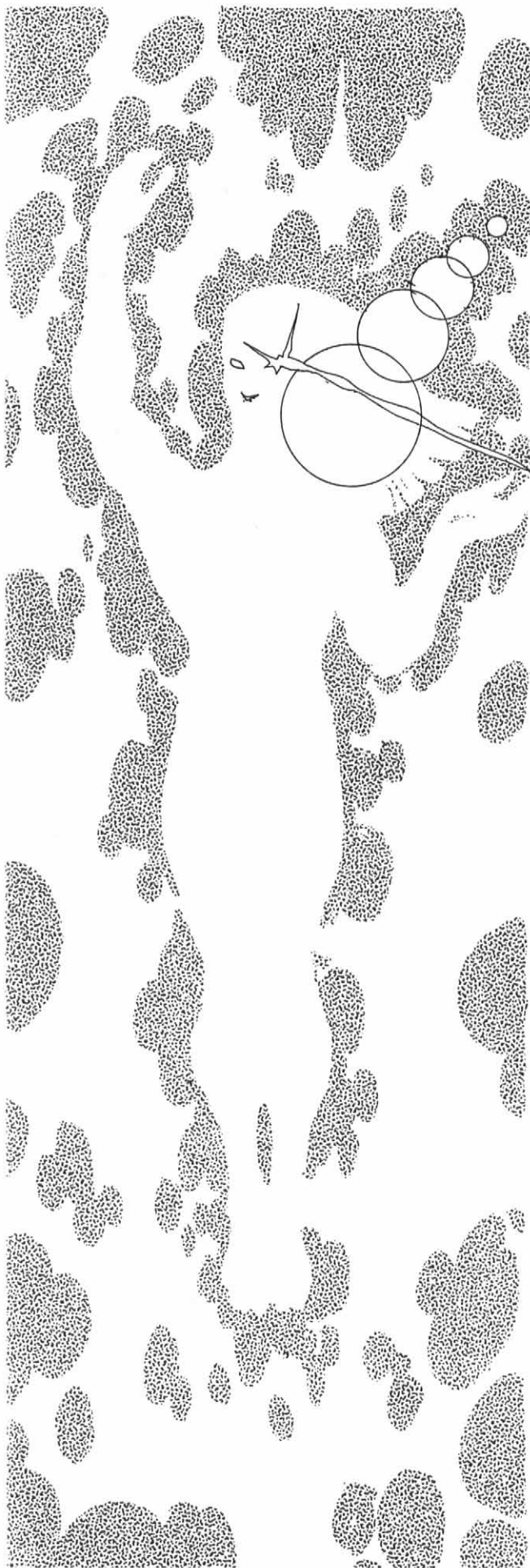

SIEMBIEDA '95

Horror Factor: 14 (awe)

Level of Experience: 15th level ley line walker and psychic.

Natural Abilities: See the invisible and in total darkness (range: 2000 feet/610 m), bio-regeneration 1D4×100 M.D.C. per minute, immune to normal heat and cold, and takes half damage from mega-damage energy attacks. Healing touch restores 1D4×10 S.D.C. or M.D.C.; and dimensional teleport 88%, but only to dimensions the god has visited (which are many).

Energy Powers: Inti can manipulate light in a number of ways. These include increasing radiance to blinding levels. This light harms vampires like normal sunlight. Inti can also fire energy blasts that can inflict as much as 4D6×10 M.D. (the god can control the intensity of the blasts in 1D6 M.D. increments), with a range of 2000 feet (610 m) and at +3 to strike. Inti can also create energy fields with as much as 500 M.D.C. (creating a force field costs 100 P.P.E.) and use them around himself or to protect/imprison targets up to 1000 feet (305 m) away.

O.C.C. Skills of Note: Magically knows all languages, literate in Dragonese/Elven, Spanish, Quechua, and American. Plus knows demon and monster lore 98%, faerie lore 98%, detect ambush and concealment 98%, and holistic medicine 98%.

Combat abilities: Equal to hand to hand: martial arts with special bonuses.

Attacks Per Melee Round: Six

Damage: As per Supernatural P.S.

Bonuses: +3 on initiative, +7 to strike, +10 to parry and dodge, +4 to roll with impact, +6 to pull punch, +10 to save vs horror factor. These include all bonuses available to the god.

Magical Knowledge: Knows all spells from levels 1-15. Equal to a 15th level wizard. **P.P.E.:** 5,000

Psionic Powers: Has all sensitive and physical powers, equal to a 15th level mind melter. **I.S.P.:** 700

Vulnerabilities/Penalties: Takes triple damage from rune weapons of evil alignment.

Alliances and Allies: In addition to the gods of light, for the last hundred years or so, Inti has been in contact with an ancient Temporal Raider (see *Rifts England*, page 72) called *Eingred*. *Eingred* has been spinning tales of great sources of power in other dimensions, and Inti is beginning to believe the creature. Unknown to him, the temporal raider is working side by side with a goqua (see *Rifts Conversion Book One*) who is trying to corrupt the god. Inti is being tricked into abandoning his principles for the sake of power and vengeance.

Weapons and Armor: None. Inti relies exclusively on his powers.

Money: Inti has access to billions of credits in cash and equipment.

Pachamama, the All Mother

There are many legends of living worlds in the Megaverse. The fabulous world of **Wormwood** is one of them. The planet **Paxull** was another. Paxull was a living elemental world, and Pachamama (then called simply the Paxa, the Great Mother) was as much a part of that world as the brain is part of the human body. She was a semi-elemental being associated with the earth,

a creature who could feel, monitor and understand everything that occurred within the living planet! Paxa lived in happiness, in a world completely alien to human thought and emotion, but yet wonderful in its own way. A world where everything had a place and lived in peace with all around it.

This peace was shattered by the coming of three Dominators (see *Rifts Dimension Book Two: Phase World*), beings of near-godlike power who loved to conquer and plunder for its own sake. Paxull was an ideal place for these raiders, full of mineral wealth, and seemingly unused to the ways of war. The invaders were surprised by the spirited resistance the living world displayed. Under the leadership of Paxa, the elemental beings of the planet fought for their survival with incredible courage. One of the Dominators was killed, and hundreds of their robotic servants were destroyed. The two remaining despoilers, however, simply took their giant ships up to orbit, and bombed the helpless planet. Paxa felt the world die. Her scream for help transcended the dimensions and attracted the attention of Viracocha and Inti. The two gods were able to trace the cries for help and teleported to Paxull. They arrived just in time to witness the death-blow to the planet, as an antimatter device literally carved out its heart!

Inti and Viracocha each went after one of the Dominators. After a savage battle, the evil creatures were destroyed. Unfortunately, there was little they could do to repair the damage the fiends had inflicted on the world. Paxull was dying, and with it, everything that lived in it. Amidst the carnage, Viracocha found a life force that was semi-independent from the whole; it was Paxa, who, in her role as the guiding force of the planet, had to distance herself from it. In a unique feat of psychic surgery, they managed to sever Paxa's life energy from the dying planet's. The operation almost killed the god-like being, but she survived even after her world was transformed into a crumbling ball of dust.

At first, Paxa bore nothing but hatred toward her rescuers. The ache of loss was too strong to endure, or so she thought. It took all of Viracocha's patience and wisdom to teach her otherwise. Eventually, Paxa's feelings changed from resentment to love, and she became Viracocha's lover and joined his pantheon. The goddess discovered that she could still link to the living spirit of every planet that contained the spark of life. She could help life flourish and sense its presence whenever she touched the earth. This connection was something wonderful, but also a constant source of pain. Every time the Pantheon of the Sun lost a world, she felt the pain most severely. It was as if she was a matron who, having lost her first child, adopted and cared for other children, only to see them die in turn. The Andean natives of Peru named her Pachamama, the "Lady of the Earth." She has resolved that this world will not die.

Originally, Paxa's form was utterly inhuman, a mound of earth that could produce limbs at will, with no apparent sensory organs. With Viracocha's help, she learned to adopt and cherish a humanoid form, and now she can appear at will as a stunningly beautiful woman, an attractive but stern elderly lady, or any form in between.

Alignment: Principled

M.D.C.: 12,000 (60,000 in Cuzco).

Attributes: I.Q. 30, M.E. 28, M.A. 32, P.S. 28, P.P. 20, P.E. 30, P.B. 24 (in human form), Spd. 70



Disposition: The goddess often has a distracted appearance, owing to the fact that she is constantly listening to the "music of life" as she calls it. She is extremely compassionate and friendly even towards her lowest servants, and loves all life. Pachamama is not incapable of killing when necessary, however; to the goddess, death is a part of life and nothing to be hated. Needless death is something else altogether, and she despises those who inflict torment and torture. The goddess also hates the undead, who are a mockery of all she holds dear. She has so far been blocked from discovering where the Blood Weeper (described elsewhere) has his city of the dead, but if she ever finds it she will fall upon it with a vengeance.

Horror Factor: 12 (awe)

Level of Experience: Equal to a 20th level warlock and mind melter.

Natural Abilities: Bio-regeneration 2D6×10 M.D.C. per melee round, see the invisible, takes half damage from all non-magical attacks.

Link with the Earth: This powerful ability is partially psionic and partially magical. Pachamama can become one with any planet that has life on it. Through this link, she can sense where and how much life is in the world, and can even find the whereabouts of any individual she knows as long as that person is standing on/over soil or earth; concrete/paved roads, inside buildings and similar man-made structures will *block* her senses. The goddess can also sense earthquakes, volcanic activity, hurricanes, weather patterns, Millennium Trees, ley lines, Rifts and other phenomena, anywhere on the planet! However, she can only pay attention to five or six events at any given time.

Powers Over Life: Pachamama can cause crops to grow 20% faster than normal and can increase crop yields by as much as 50%, over an area of 200 miles (320 km). The goddess does not use this power much, because such changes will bring bad consequences at a later date. For example, a nearby region might suffer because of the goddess' interference. She can also heal others of up to 100 points of damage (S.D.C. or M.D.C.) every melee round! She can even bring back the dead (75% chance, at -1% per day since the death of the person, to a minimum level of 20% for up to a year, or 10% if the person has been dead for more than one year).

O.C.C. Skills of Note: Magically knows all languages, literate in Dragonese/Elven, Spanish, Quechua, and American. Plus demon and monster lore 98%, faerie lore 98%, holistic medicine 98%.

Combat abilities: Equal to Hand to Hand: Basic.

Attacks Per Melee Round: Five

Damage: As per supernatural P.S.

Bonuses: +1 on initiative, +5 to strike, +6 to parry and dodge, +4 to roll/pull punch, +4 to save vs magic, +10 to save vs horror factor. These include all bonuses available to the god.

Magical Knowledge: Knows all earth warlock spells. Equal to a 20th level warlock. **P.P.E.:** 9,000

Psionic Powers: Has all sensitive, healing and physical powers, all at 20th level of proficiency, plus psi-sword (14D6 M.D. or 2D4×10 M.D.) **I.S.P.:** 2,000

Vulnerabilities/Penalties: None

Alliances and Allies: Pachamama has some connections to the elemental plane of earth; she can actually understand the alien beings that inhabit this plane, and she is greatly respected and admired by them.

Minions: Pachamama can summon 2D6 minor earth elementals and in an emergency, call as many as 5,000 minor earth elementals and 500 greater ones!

Weapons and Armor: None

Money: Has access to billions of credits.

Illapa, God of Thunder & Storm

This semi-elemental god has control over the weather and has been worshipped throughout the Megaverse as a fertility deity, bringing rains in return for the worship of the faithful. Illapa was an independent deity on a small, sparsely populated world when he first met Viracocha and his companions. Illapa's world was being plagued by demons and evil entities. His few remaining worshippers, priests, and even the god himself had been unable to stop the demons' depredations. Viracocha was able to follow the monsters to their plane of origin, where, together with Illapa and the gods of his growing pantheon, they confronted the demon lord responsible for the raids. The demon was no match for the combined might of the gods, and was quickly defeated. Illapa realized that this and similar threats to the Megaverse had to be dealt with, so he joined the Pantheon of the Sun.

During the first Inca period, Illapa was widely worshipped. Any children born in an open field during a thunderstorm were dedicated to him as a priest, and was said to be a "son of Illapa."

This custom is still followed in the new Empire, and those priests are gifted with increased elemental powers.

Illapa usually adopts a humanoid shape when appearing in front of his worshippers, dressed in traditional Inca clothing, surrounded by a crackling aura or energy, sometimes with electrical arcs forming over his head. He wields two powerful rune weapons, the mace of the elements and the golden sling of thunder. The god often ventures into the astral plane, from which he visits priests and heroes with dreams and visions. These visitations occur most often during storms, at which time the priests of Illapa often go into a trance to receive visions, inspiration and divine guidance.

Alignment: Principled

M.D.C.: 9,000 (45,000 in the Cuzco area).

S.D.C./Hit Points: Astral form has 4,000 S.D.C. and has no connecting silver cord.

Attributes: I.Q. 22, M.E. 18, M.A. 22, P.S. 40, P.P. 26, P.E. 23, P.B. 4, Spd. 60 running, can fly at up to Mach 10.

Disposition: Illapa is both a warrior and fertility god. He is concerned with the welfare of his people, and is ready to fight for them. The god hates weather-manipulating deities who use their powers to blackmail or dominate helpless beings. One of the chief offenders of this type of control is the Aztec god Tlaloc (see *Rifts Conversion Book Two: Pantheons of the Megaverse*). Tlaloc is just now becoming active in the Yucatan area, so the two gods are likely to clash. In fact, Illapa wants his pantheon to declare war on the Aztec gods. Viracocha prefers to wait and see what the Aztec are up to before he declares war, and Inti wants to regain more power before striking. If Tlaloc's crimes continue, Illapa may find himself unable to control his rage and a god war may rage in South America.

Horror Factor: 13 (awe)

Level of Experience: Equal to a 20th level air and water warlock.

Natural Abilities: Turn invisible at will, see the invisible, bio-regeneration 3D6×10 M.D.C. per minute, takes no damage from electrical attacks (including magical lightning) and half damage from all non-magical energy attacks. Can fly at speeds of up to Mach 10, teleport without error up to 100 miles (160 km), and dimensional teleport 88%, but only to places the god has personally visited (which are many).

Weather Control: Once every hour, Illapa can start or stop rain over a 100 mile (160 km) radius. By spending 100 P.P.E., he can reshape the weather over a 500 mile (800 km) radius! The god uses this power sparingly, however, because such manipulations of weather often have unpredictable and negative consequences, including droughts in other areas, flooding, hurricanes, storms, and other problems.

Elemental Control: Illapa can try to control any air or water elemental within his line of sight. Most elementals will respect and obey him without having to use this power, but if they choose to disobey the god, they must make a save versus ritual magic or they will be coerced into obeying him. Additionally, Illapa can negate any air or water elemental spells by spending 15 P.P.E. (no saving throw applicable!).

Astral Powers: The god can transform his whole body into an astral form, unfettered from the real world. No body is left behind as Illapa ventures into the astral plane. While in astral form, Illapa can use any of the abilities of astral travelers,

plus he can enter the dreams of people sleeping or meditating. During these visitations, Illapa can create images and entire landscapes, hiding his true identity or appearing "in person" to offer advice or guidance to the dreamer.

O.C.C. Skills of Note: Knows all languages magically. Literate in over 20, including Quechua, Spanish, Aymara and English/American. Plus demon and monster lore, faerie lore, and wilderness survival, all at 98%, plus W.P. archery and targeting and W.P. blunt.

Combat abilities: Equal to Hand to Hand: Martial Arts with extra bonuses.

Attacks Per Melee Round: Eight

Damage: As per supernatural P.S.

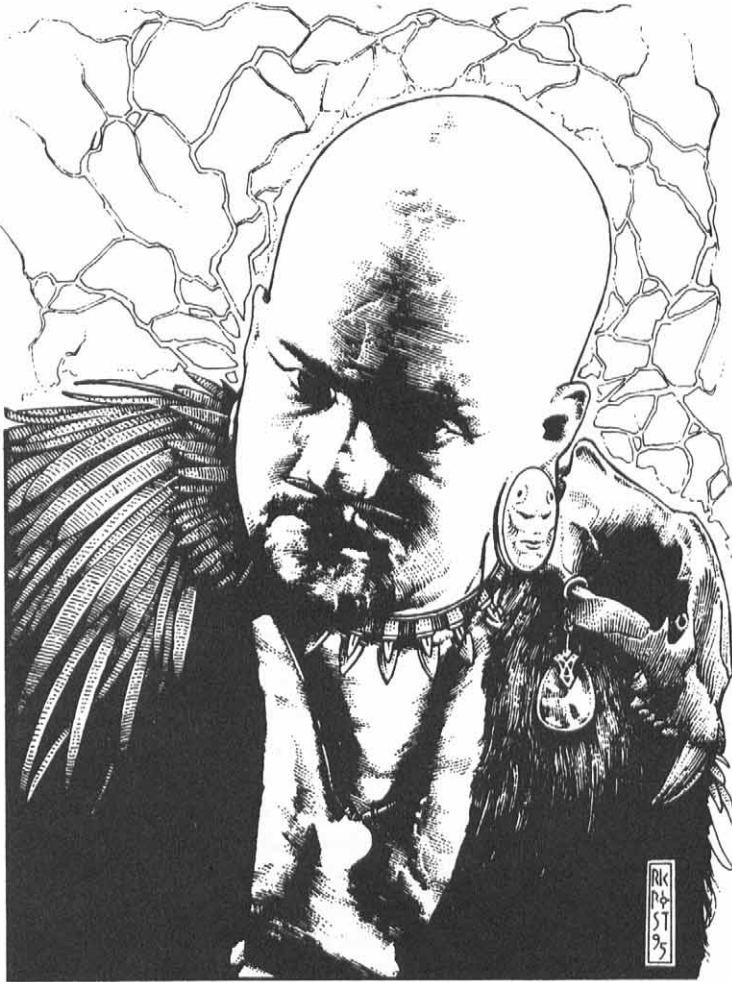

Bonuses: +3 on initiative, +10 to strike, +12 to parry and dodge, +6 to roll with impact, +8 to pull punch, +5 to save vs magic, +8 to save vs horror factor. These include all bonuses available to the god.

Magical Knowledge: Knows all air and water warlock spells from levels 1-8 at 20th level proficiency. **P.P.E.:** 6,000

Psionic Powers: All sensitive powers (plus see his special astral powers, above). Equal to a 10th level psychic. **I.S.P.:** 700

Vulnerabilities/Penalties: None.

Alliances and Allies: As a warlock god, Illapa has connections with the elemental planes, specifically the air and water planes. Some elemental intelligences know and respect the god, but others have come to hate and resent the deity's influence.

Weapons:

The Mace of the Elements: This wooden club is made of the living wood of a Millennium Tree and then empowered by magical runes and holy symbols. The mace is indestructible and has the following powers:

- Inflicts 3D4×10 M.D. Any creature that takes extra damage from Millennium Trees will be affected in the same way by the club.
- Can cast the following spells three times each per day, at 10th level potency: rain dance, summon storm and drought.
- Can heal 2D6+6 S.D.C./hit points or M.D.C. up to six times a day.

The Golden Sling: This sling shoots lightning bolts, inflicting 2D6×10 M.D., with a range of 4000 feet (1220 m).

Body Armor: Typically none.

Money: As a god of the Pantheon of the Sun, Illapa has access to the entire Imperial treasury — billions of credits in cash, vehicles and equipment.

Manco Capac, The First Inca

The first and foremost among the True Incas, Manco Capac has served loyally at Viracocha's side for over 20,000 years. Manco Capac has acted as Viracocha's messenger, herald, secret agent and scout in hundreds of missions and adventures. He has confronted the minions of the Splugorth, vampires, demons, and even stranger beings and creatures, and he has traveled to hundreds of worlds and dimensions. His leadership and heroism gained the pantheon an empire on Earth, and he is recognized as the savior of the gods.

Although he could have been acclaimed as the High Priest or ruler of the Empire of the Sun, Manco Capac has kept a relatively low profile since the god's return. He prefers to be in the forefront of battle rather than sitting on a throne, and he often hides his true identity from his mortal allies and companions. On more than one occasion, a simple peasant soldier or militia member has turned out to be Manco Capac in disguise, revealing his powers only when it became a matter of life and death. The godling has spent years fighting the Arkhon threat, but lately he has been sent out on missions beyond South America. Some of those missions involve exploration and discovery. The gods wish to know more about Rifts Earth, so Manco Capac and his Chosen have been dispatched to explore the world. It was Manco Capac who discovered that the Aztec god Tlaloc was active on Earth (see Illapa, above, for the results of this discovery); this discovery ended up in a short fight between the evil god and Manco Capac, a fight the godling barely survived by fleeing. Manco Capac agrees with the god Illapa that the Aztec gods must be dealt with, but has to admit that the Empire of the Sun has more than enough enemies at the moment.

The True Inca is rarely in Cuzco for more than a week at a time before he goes off on yet another mission. Realizing he could not do everything that was required of him, Manco Capac decided to recruit a group of like-minded champions. This band of heroes is known as the **Heroes of the Sun** or **Manco Capac's Chosen** (see below).

Manco Capac — Godling

Alignment: Scrupulous

M.D.C.: 601

Attributes: I.Q. 17, M.E. 20, M.A. 18, P.S. 32, P.P. 22, P.E. 25, P.B. 22, Spd. 30

Disposition: The character is truly a heroic figure, yet Manco Capac can be surprisingly humble and down to earth. He has a sense of humor about most things, and is unexpectedly friendly and warm towards the common people, always ready to offer a soothing smile to calm frightened children and reassure adults. When confronted with supernatural evil, he will become a grim avenger, giving no quarter to such beings as vampires, demons and devils.

Horror Factor: 10 if his true nature is revealed, 11 if his true identity is revealed.

Level of Experience: 14th level True Inca (Godling)

Natural Abilities: See the invisible, regeneration (1D4×10 M.D.C. per minute/4 melee rounds), and nightvision 200 feet (61.0 m), and can exorcise spirits (60% plus 3% per additional level), and is immune to all forms of possession and mind control.

O.C.C. Skills of Note: Dragonese/Elven 98%, Quechua 98%, Spanish 98%, American 98%, demon and monster lore (98%), wilderness survival (98%), W.P. energy rifle, energy pistol, sword, archery and targeting, blunt and heavy energy weapons.

Combat abilities: Hand to Hand: Martial Arts plus boxing and special bonuses.

Attacks Per Melee Round: Seven hand to hand or two by magic.

Damage: As per supernatural P.S.

Bonuses: +4 on initiative, +7 to strike, +10 to parry and dodge, +5 to roll with impact, +6 to pull punch, +2 save vs magic, +8 to save vs horror factor.

Magical Knowledge: Knows all spells from levels 1-3 plus carpet of adhesion, heal wounds, call lightning, fire ball, fly as the eagle and mystic portal. **P.P.E.:** 305

Psionic Powers: Knows all sensitive and healing powers. **I.S.P.:** 132

Vulnerabilities/Penalties: None per se.

Alliances and Allies: See the Heroes of the Sun, below.

Weapons:

The Sword of Manco Inca: This was a Spanish greatsword that was captured by one of the last Inca kings, who called himself Manco Inca. The sword was enchanted and blessed by the greatest Inca sorcerers and priests of the time, and after the death of Manco Inca it was kept hidden in a remote mountain fortress. Manco Capac found the sword, which after the Coming of the Rifts had become a powerful holy weapon, and he has kept it as his sidearm of choice.

The powers of the Sword:

- Inflicts 6D6+6 M.D.
- Can heal 1D6+6 S.D.C. or M.D.C. points six times a day.
- Does double damage to vampires and alien intelligences.
- Can sense evil as per the spell (equal to an 8th level spell), six times per day.
- Can cast the Armor of Ithan spell (100 M.D.C.) around the wearer, three times per day.

Body Armor: Gilded Body Armor (70 M.D.C.).

Money: Has access to 4D6 million credits on a moment's notice, and ten times as much if he needs it in a matter of a day or so.

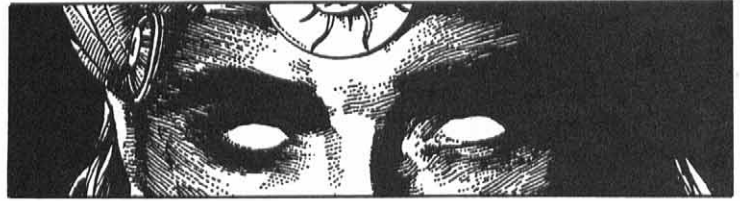

The Heroes of the Sun: Manco Capac's Chosen

In his travels through the Megaverse, Manco Capac has encountered a number of champions dedicated to fighting the forces of darkness. Some of these heroes have joined forces with the godling and eventually created the organization known as *the Heroes of the Sun*. This group often operates independently of the gods, even though its members answer to Manco Capac. The god Viracocha has granted the heroes permission to act as they see fit, and all members have the military rank of captain and can command and deputize other soldiers in the war against the darkness. Any abuse of powers will bring down the rage of Manco Capac and the gods themselves, but in the 300 year history of the Chosen, no such incident has occurred.

The Chosen are experienced warriors, magicians and supernatural creatures of a good alignment. Among their number are beings who are more powerful than Manco Capac himself, but all respect the godling's experience and abilities. Typically, members are assigned missions, including quests for lost or stolen artifacts of power, exploration and espionage, rescue missions, hunting monsters and supernatural predators, and other missions.

Members of the Chosen:

There are about 200 Heroes of the Sun active at any one time. The exact numbers keep changing, but some of the most notable members include:

- 12 dragons: 10 hatchlings of different species (including a Chiang-Ku dragon, see *Rifts England*), and 2 adult dragons.
- 4 Cosmo-knights (see *Rifts Dimension Book Two: Phase World*), levels 1-6. These champions are often sent to other places in the Megaverse for important missions. A fifth cosmo-knight tried to leave Earth's atmosphere and has not been heard of since.
- 10-20 True Incas (godlings and demigods), Manco Capac's personal retainers.
- 9 Anti-Monsters (see *Rifts South America: One*) who have decided to fight for all of humankind.
- 10-20 True Atlanteans, including several Undead Slayers.
- About a dozen godlings and demigods from other pantheons.
- Dozens of assorted D-Bees, mutants and beings with special or unique powers and a courageous spirit.
- Dozens of magicians, psychics, cyber-knights and other champions.

Using the Heroes of the Sun in Your Campaign

An entire campaign could be based around the adventures of the Chosen. The player characters could come from all parts of the Megaverse, from different areas of Rifts Earth and places like Wormwood, Phase World or even other RPG or fictional settings. They could be official members of the Heroes of the Sun or adventurers and heroes who the Chosen regard as worthy associates, potential new members or simply people worth helping.

The Heroes of the Sun can provide focus and direction for any group of heroes, assigning missions and quests, and identifying places and perpetrators of great evil. Alternatively, the player characters need not be associated with the Chosen.

As an alternative, they might encounter members of this group in diverse situations; maybe both the player characters and the Chosen are seeking the same object or person. Do they have the same intentions towards that object? Will they fight over it? Any number of plot lines and scenarios can be built around this organization.

Forces of Darkness

Not all the supernatural beings who returned to Peru after the Great Cataclysm are benevolent. Many are evil predators and despoilers, a threat to both the Empire of the Sun and all mortals on the continent. The two most important supernatural threats to the Andean civilizations come from the mythical past: the Ancients, undead beings of immense power, and the Pucara or Red Giants, an ancient race that was driven into hiding by early humans and who now want revenge.

The Ancient R.C.C. Incan Undead

The practice of mummification was common in the Andes region before the rise of the Incas. The early True Incas did not condone it, however, because it smacked of necromancy. After the gods and their progeny had left the Incas, mummification was revived. The human Incas had seen how the slumbering gods had been kept in a holy magical place from which they eventually awakened. In an attempt to imitate that feat, the bodies of Emperors and noblemen were specially treated, freeze-dried, dressed in luxurious cloaks and masks, and stored in *huacas*, places of magic. Magical rituals were conducted throughout the mummification process, but the weak magical energies of pre-Rifts Earth were not enough to allow the rituals to work in their entirety.

Over the centuries, many mummies were destroyed, buried under avalanches, burned by European explorers, or looted for gold and jewels. A few were kept in museums, displayed for the entertainment of modern peoples, and a small number, maybe no more than a few dozen, remained hidden in ancient huacas, in their original resting places.

Unknown to the ancient weavers of magic, their rituals had worked far better than they would know. The life-force of the mummified Incas had been bound to their mummified bodies. These unfortunates were trapped in immobile, useless bodies! Centuries passed, and many of the once-proud Incas became insane due to their long imprisonment. A few managed to travel astrally, and wandered the world as formless spirits, or journeyed into the mysterious astral plane. Some of those travelers learned many secrets of magic and psionics, and they communi-

cated them to their fellow mummies. They even managed to curse many of the looters and despoilers of their tombs. Despite, or maybe because of their astral powers, the mummies were all consumed by insanity and hatred for all living things.

When the Great Cataclysm struck, the rituals that had preserved the Incas' bodies for centuries suddenly flared in power. The Ancients' bodies moved, fueled by supernatural energies. Mummified bodies broke out of museum display cases, buried tombs, and other resting places. Many spent the next few months plunging into an orgy of destruction, killing terrified humans even as their cities collapsed. Others hid in the mountains, revealing themselves only to a chosen few, who worshipped the mummies as gods.

When the true Inca gods returned to Earth, however, they saw these beings as aberrations to be destroyed. The Ancients plaguing the city of Cuzco were hunted down and destroyed by the gods in spectacular but one-sided battles. Even with all his supernatural and undead powers, an Ancient was no match for a full-fledged deity. The rest fled and hid. Many turned to the most powerful among them, the former **Emperor Yahuar Huacac** (see below), for guidance. The dreaded "Blood Weeper," over a dozen Ancients, and hundreds of followers retreated to a remote mountain fortress, and now dwell therein, in the so-called **City of the Dead**. Other Ancients work alone or in small groups, hiding in the vast Andes chain, or in the teeming jungles, where they work mischief on humans and other easy victims.

The Ancients all look like dried-out corpses. Their skin clings to their bones, their eyes are sunken, and their faces look like skulls with wrinkled skin. Their hair is typically long, and their ears are pierced with the traditional Inca earplugs. Many wear their burial masks and cloaks to cover their withered forms. Despite their apparent frailty, the Ancients are incredibly strong, able to crumple stone in their bare hands, and are supernatural beings who can survive attacks from M.D. weapons.

In addition to their supernatural attributes, the Ancients have a host of magical and psionic powers, learned over centuries of astral travel. Additionally, they have an undead withering touch they can use at will; this touch causes the victim to shrivel up and weaken, prolonged or repeated touches can kill all but the most powerful entities — even gods can be harmed and weakened by this evil power. Thankfully, the effects are temporary, unless the victim is killed by them.



For all their power, the Ancients have one fear: fire. Even normal flames will harm their undead flesh. To protect themselves, these creatures enchant their garments or project magical force fields to keep dangerous flames at bay.

Note: The Ancients are powerful, evil entities not suitable as player characters.

Alignment: Any evil, but usually miscreant or diabolic.

Attributes: I.Q. 3D6+8, M.E. 3D6+6, M.A. 3D6, P.S. 4D6+24, P.P. 3D6+8, P.E. 3D6+4, P.B. 1D6, Spd. 4D6+6

Size: Average height is five feet, five inches (1.65 m).

M.D.C.: 1D4×1000

Horror Factor: 14

Average Life Span: Undead; will never age or “die,” but can be destroyed.

Experience Level: Average 1D4+5

Natural Abilities: Undead being that can exist indefinitely.

Night vision (range: 2000 feet/610 m; can see in total darkness), regenerate 2D6×10 M.D.C. every minute (4 melee rounds); but see vulnerabilities, below. The undead fiends also take half damage from all non-magical weapons except those that are fire-based (includes plasma weapons, but not ion, particle beam or laser weapons).

Withering Touch: On a successful hand to hand attack (does no damage other than the withering touch), the Ancient can use his withering touch on a victim. The target can try to save against magic (14 or higher against this powerful effect); on a *successful* save the victim takes 2D6 damage to either M.D.C. or hit points, and is -1 to strike, parry and dodge for that round.

If the save fails, the victim takes 1D4×10 to M.D.C. or hit points, and is racked by pain from the draining. All attacks, bonuses and skills are reduced by half for 1D4 melee rounds; furthermore, the victim’s P.E. is temporarily reduced by 1D6; this temporary loss is cumulative, and should P.E. be reduced to zero or below, the character falls into a coma and must roll to survive it! Powerful supernatural beings like godlings, dragons or demigods are at +25% to survive the coma (gods are temporarily knocked unconscious for 1D4 melee rounds). This P.E. loss is temporary; mortals regain P.E. at the rate of one per day; supernatural beings regain 1D6 P.E. per day, and gods regain it at the rate of 1D6 per minute!

The withering touch can affect characters wearing body armor, but not those wearing power armor or piloting a robot or vehicle. Full conversion Cyborgs take no M.D.C. or hit point damage, but do suffer the weakening and draining effects of the touch.

Undead Control: The Ancients have great power over all types of undead. They can raise, animate and control 1D6 dead per level of experience. They can also attempt to control vampires (use the tables in *Rifts Vampire Kingdoms*, and treat the Ancient as a Master Vampire from another intelligence). Ancients are immune to mind control, mental effects, possession of other undead, as well as the vampire’s slow kill bite.

R.C.C. Skills: Quechua and five other languages at 98%, seven Technical skills at +20%, and ten additional skills at +5% (if applicable); typically weapon proficiencies, hand to hand skills (basic counts as one selection, expert counts as two, and martial arts or assassin counts as three selections), wilderness or domestic skills, and similar areas of knowledge; very rarely will they be interested in technological skills.

Combat: As per skill, but has one additional melee attack bonus.

Damage: As per supernatural strength (see *Rifts Conversion Book One*, page 22). When fighting vampires, the Ancient’s attacks do damage as a master vampire (see *Rifts Vampire Kingdoms* for more information).

Bonuses: +1 to strike, +1 to parry, +2 to dodge, +3 to save vs magic, +9 to save vs horror factor, plus attribute and skill bonuses.

Magic Powers: Knows all spells from levels 1-5, plus three spells from each level equal to or lower than their experience level (so an 8th level Ancient would know all spells levels 1-5 and three spells each from levels 6, 7 and 8), and one spell from each of the higher levels (so in the previous example, the Ancient would also know one spell each from levels 9-15). Spells can be chosen from the common magic list or from the *necromantic* spell list (see *Rifts Africa*; half are necromancers). Spell strength improves with level as a ley line walker.

P.P.E.: 2D6×100, plus 50 per level of experience.

Psionic Powers: Knows all sensitive powers plus psi-sword and four super powers of choice. **Master psionic. I.S.P.:** 3D6×10 plus M.E. attribute. Add 12 I.S.P. per additional level of experience.

Vulnerabilities/Penalties: Fire! Even S.D.C. fire does damage (1D6 M.D. from a blow with a torch; 6D6 M.D. if tossed into a bonfire). M.D. fire attacks do double damage. Magic or psionic fire does triple damage!

Dependency on the Draining: The Ancients must drain a victim using Withering Touch at least once a month; after a month without “feeding” in this manner, the monster will lose 3D6×10 M.D.C. that cannot be healed or regenerated until he has fed. Additional months do the same amount of damage. If M.D.C. is reduced to zero in this manner, the Ancient will crumble to dust and cease to exist.

Alliances and Allies: Ancients often work with one another. Also, they sometimes form alliances with other undead creatures (including vampires), demons, necromancers, and other powerful, evil beings.

Weapons: Most ancients have enchanted clubs (inflict 3D6 M.D. in addition to supernatural strength damage); a few have captured energy weapons, TW weapons, or other magical weapons; they covet rune weapons, but very few have them.

Body Armor: Enchanted poncho and face mask: 120 M.D., and protects from flame attacks until destroyed.

Money and Equipment: Ancients sometimes accumulate a hoard of plunder worth 1D6 million credits; they have little equipment, as they need very little for their survival. Their allies, servants and followers may be equipped with technological or magical weapons.

Yahuar Huacac, the Blood Weeper

Little is known about the reign of *Yahuar Huacac* (the name is actually a nickname, the Quechua words for “Blood Weeper”), the seventh Inca Emperor. For some reason, no records of his reign were kept, and only a few fanciful stories about his nickname have been passed down over the generations. The reason behind this silence is a combination of shame and fear. The crimes of the Blood Weeper were such that future Incas decided to erase them from the memories of the people, so it was made forbidden to speak his name, or tell stories about Yahuar Huacac. Thus, the oral historians of the Incas were ordered

to forget everything about him and the horrible secret Yahuar Huacac kept.

Before his rise to the throne, the young prince was kidnapped by the Incas’ enemies, and carried through many remote and strange areas of the Andes. At some point, Yahuar met an ancient sorcerer living in the mountain. The sorcerer was an evil necromancer, so feared by the surrounding communities that nobody dared stand against him. The necromancer showed the impressionable youth the evil, twisted power of the forces of darkness, and took him on an astral voyage to the *Realms of Death*. The experience completely transformed the prince. When he returned, his eyes wept bloody tears whenever he was saddened, enraged or joyous!

Eventually, Yahuar Huacac returned to Cuzco and became the ruler of the Empire. He was beset by bouts of madness during which he would murder innocent people, laughing maniacally and weeping blood as he tortured and mutilated. Other times he behaved normally, and fathered a son and continued expanding the empire. As soon as his heir was born, however, the child was kept hidden, to spare him from the erratic murderous rages of his father.

At the end of his life, Yahuar Huacac had acquired a diabolical reputation as a murderous madman and practitioner of the black arts. He was mummified, but his body was interred far away from Cuzco, high in the mountains. There, Yahuar Huacac’s, an undead, formless spirit hovered near his body, slowly growing in power. He had learned the secrets of necromancy, and further travels into the Death Realms strengthened his magical abilities. He made pacts with supernatural intelligences to further his power to the point that he rivals the gods in sheer might, and surpasses most of them in malevolence.

The pursuit of power is Yahuar Huacac’s only concern. Power over the living and the undead, as well as power over the material and astral planes. This Ancient is even more powerful than the rest of his unholy kin. The mummy still can weep tears of blood — tears that can cause fear and burn through flesh and stone! Also, Yahuar has links to the gods of darkness, and can call upon some of these evil beings for assistance.

A sadistic, erratic murderer in life, the Blood Weeper has become even worse in Undeath. Centuries of jealousy against the living has only sharpened his lust for inflicting pain and misery. His **City of Death** is a hellish place, where howls of agony and despair can be heard, day or night, echoing through stone walls and houses. His “court” is a huge chamber, decorated with skulls and gruesome, mutilated corpses. He is attended by vampires, zombies and demons. His principal advisor is a disgusting Goqua (see *Rifts Conversion Book One*) named **Sinchi Yahuar**, the Lord of Blood. This evil trickster is the chief spy, diplomat and organizer of the city, and he is dedicated to the destruction of the Empire of the Sun, just as his master is. Rumor has it that Sinchi Yahuar was nearly destroyed by Viracocha millennia ago, during a conflict over a tribe of humans the goqua was preying on. Thus, the disgusting creature has sworn revenge on the god’s entire pantheon.

Yahuar Huacac hates his former gods. Even before his death, he had rejected them and the forces of light for the powers of darkness. After the Great Cataclysm, he fought Manco Capac and his band of heroes, demigods and warriors. Despite his powers, Yahuar Huacac was forced to retreat after his demon and

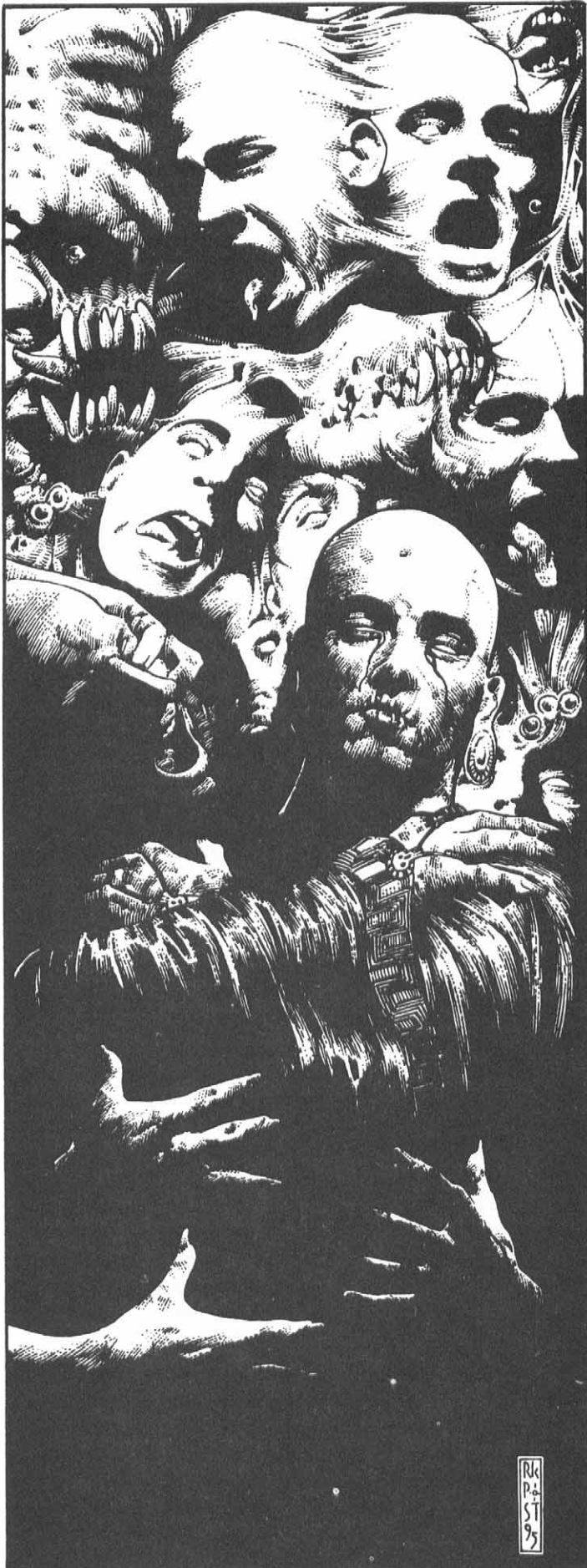

vampire bodyguards were destroyed. The Ancient has sworn revenge against the godling, and he will reserve his worst tortures for the Heroes of the Sun and any other friend or ally of Manco Capac.

Alignment: Diabolic and maniacal.

M.D.C.: 6,000 (enhanced through the power of the forces of darkness).

Attributes: I.Q. 25, M.E. 19, M.A. 13, P.S. 40, P.P. 23, P.E. 18, P.B. 3, Spd. 22

Disposition: Whatever little humanity was left in the murderous necromancer has been burned away by his years as an Undead. The creature lives only to increase his power, both magical and political. His dream of reclaiming the Inca Empire has now been twisted, and he wishes to rule a huge realm of the walking dead that extends from coast to coast. A land where no living being survives.

Horror Factor: 16

Level of Experience: 12th level Ancient and Necromancer

Natural Abilities: Nightvision (range: 2000 feet/610 m; can see in total darkness), regenerate 2D6×10 M.D.C. every minute (4 melee rounds), but see vulnerabilities, below. Takes half damage from all non-magical weapons except those that are fire-based.

Blood Weeping: When angered or gripped by a strong emotion, Yahuar starts weeping blood. His horror factor is raised to 18 when this occurs. The fiend can also fling droplets of blood by shaking his face. Range is limited to 10 feet (3 m) and counts as an additional attack that inflicts 4D6 M.D. on any material (the blood burns like acid), plus victims must save vs magic or be consumed by fear! Fright-filled characters will wish to flee from the Blood Weeper; if they are unable or unwilling to escape, they must make a save vs horror factor 18 at the beginning of every round; the effects of a failed horror factor save are standard (see *Rifts RPG*, page 114); people who successfully save vs magic are unaffected.

Withering Touch: Same as the Ancient R.C.C.; see that description for details.

Undead Control: As a powerful necromancer, the Blood Weeper has great power over all types of undead, even beyond the capabilities of normal Ancients. He can raise, animate and control 3D4×10 dead every day. He can also attempt to control vampires (use the tables in *Rifts Vampire Kingdoms*, and treat the Ancient as a Master Vampire from another intelligence). Like all Ancients, the Blood Weeper is immune to the mind control of other undead, as well as possession and the vampire's slow kill bite.

Necromantic Powers: Yahuar Huacac has all the standard necromantic powers described in *Rifts Africa*. Among these is the ability to wear magically animated remains of supernatural creatures as armor, control the dead, and access to many powerful spells.

Vulnerabilities: Same as the Ancient R.C.C.

R.C.C. Skills of Note: Literate and fluent in the following languages (98%): Spanish, Quechua, Aymara, Creole and American. Plus demon and monster lore 98%, vampire and undead lore 98%, and W.P. sword.

Combat abilities: Equal to Hand to Hand: Assassin

Attacks Per Melee Round: Seven or two by magic.

Damage: As per supernatural P.S.

Bonuses (all): +1 on initiative, +9 to strike, +9 to parry and dodge, +4 to roll with impact, +4 to pull punch, +3 to save vs magic, and +10 to save vs horror factor.

Magical Knowledge: Knows all spells from levels 1-10, plus all necromantic spells (see *Rifts Africa*). **P.P.E.:** 1,500

Psionic Powers: Knows all sensitive powers plus empathic transmission, hypnotic suggestion, mentally possess others, psi-shield, and psi-sword (12D6 M.D.). **I.S.P.:** 241

Alliances and Allies: Sinchi Yahuar, a Goqua (see *Rifts Conversion Book One*), is his trusted advisor. He also has a tentative alliance with a vampire intelligence, and often consorts with necromancers, alien intelligences, demons, vampires, and other enemies of humanity.

Minions: Dozens of lesser Ancients, zombies, mummies, skeletons, ghouls, dar'ota, dybbuk, a couple of evil dragons, and undead of all kinds.

Weapons: Relies on his powers and psi-sword.

Body Armor: Enchanted poncho and face mask: 120 M.D., that protects from flame attacks until destroyed.

Money: The Blood Weeper has over 10 billion credits in gold, jewels, captured equipment and other treasure. Most of it is buried in the catacombs beneath the City of the Dead, protected by all manner of demons and supernatural monsters.

The Pucara, the Red Giants

Population Breakdown: 200,000, scattered among several dozen kingdoms in Peru and the southern portion of South America (most stay in the mountains).

In the years following the coming of the rifts, a race of tall red-skinned giants has plagued the Andes and surrounding lands. Alternatively called the Pucara, the Red Giants, or the Red People, these strange creatures have become one of the scourges of the region. They have seemingly appeared out of nowhere and launch raids against all people. Both the Incas and the Arkhons have suffered from those raids, as the Pucara attack all others without prejudice. The natural assumption is that, like the Brod-kil, Larhold, and other alien creatures, the Red People are D-Bee monsters. The Nazca people know the bitter truth, however. These giants are *native* to Earth, and have a rightful claim as the oldest inhabitants of the Andes mountains!

Thousands of years ago, even as the predecessors of the Nazcans were first coming south from North America, and as the Atlanteans were beginning to build their civilization, an ancient race dwelt in the mountains. Perhaps they migrated from another dimension, or maybe they evolved on Earth; nobody knows. The Pucara (or "the People," as they called themselves) had an old and advanced civilization before the first humans ever set foot on the continent.

Living high in the mountains, these giants were masters of psionic powers, which included control over the earth and stone, somewhat similar to those of Atlantean stone masters. Some Red Giants even claim that it was they who taught the secrets of stone magic to the first Atlanteans (this claim is a lie; the giants' earth control is psionic in nature, while the Atlanteans' stone

mastery is magical). They had no central empire, but a number of small kingdoms. Warfare between those tiny nations was common and brutal. These conflicts kept the Red Giants too busy to notice the small human nomads that started moving into the jungles and lowlands. Content in their great mountain castles, the Pucara paid no heed to those "unimportant savages."

Two millennia later, things changed, as Atlantis rose to the height of its power, Lemuria flourished to the West, and the Nazca peoples discovered the secrets of line magic and started building their energy cities on high mountain plateaus. Contact between the Giant Kings and the Nazca sorcerers became inevitable. The Red People were divided on this issue: some kings and their advisors believed that peaceful coexistence with the Nazca was not only possible, but desirable. Most of them, however, reacted with either greed or fear; greed for the secrets of line making magic, and fear that the rapidly multiplying humans would overrun them. In two thousand years, while the numbers of the Pucara had barely increased by one-fifth, humans had multiplied tenfold! The giant race was long-lived, but took years to reproduce; humans were the total reverse. Already they outnumbered the Red People; in a few centuries, many feared there would be too many for the two races to survive.

Fear and greed won out. For the first time in the Pucara's history, a High King was selected, the most brutal and warlike conqueror among them. The High King and a mighty army descended from the peaks of the Andes, slaughtering everyone in their path. Most of the first victims were primitive villagers with no contact with the Nazca, but soon a stream of refugees reached the Nazca plateau, bringing news of the destroying army.

The Nazca sorcerer-kings reacted swiftly, creating a new breed of soldier, the dreaded *Rune Warriors*. The Nazca hosts, armed with magical weapons, and drawing on the power of the great network of ley lines they had built, prepared for the oncoming enemy. It took years before the Pucara invaded the Nazca kingdom. In the meanwhile, they butchered tens of thousands of innocent humans. Potential young civilizations, some of which might have one day rivaled Nazca or Atlantis, were wiped out. Then the Pucara and the Nazcans collided.

The battle that followed was referred to as legends of the end of the world. Earthquakes and ley line storms were launched against each other. Airborne sorcerers exchanged lightning bolts while armies battled and bled below. The Red Giants were outnumbered, but their size, strength and psychic prowess more than made up for it. Their greatest mind mages controlled human soldiers, created terrifying illusions, sent rocks raining down on the heads of their enemies, and melted the ground beneath them! In response, the Nazcas released the raw power of their line drawings, creating giant energy creatures, releasing bolts of pure force, and shattering the giants' formations.

The Nazcas prevailed. They had numbers and magical power on their side, and they enjoyed unified command, while even the High King of the Pucara could not count on the full obedience of his warriors. Dozens of groups of Red Giants, starting with the ones who had opposed the war, retreated from the field of battle. Dividing in the face of the enemy, the Pucara host shattered like a dropped glass bottle, with fragments fleeing in every direction.

The war was not over, however. Enraged by the crimes the Red Giants had committed on their way to the plateau, the



Nazcans swore revenge, and their own armies pursued the fleeing enemies, killing them without quarter. When the Nazca forces reached the first giant stronghold, they utterly destroyed it with a ley line storm. They did the same to the second and third ones. Realizing they now were faced with a fight for survival, the remaining Pucara Kingdoms united once again, and forced battle on the narrow mountain passes where they had the advantage. Though they fought ferociously, the giants were completely outnumbered, and the Nazcans were relentless. Defeat followed defeat, and more strongholds fell. This savage conflict lasted twenty years.

At its end, less than one in ten Pucara survived, huddled in the last stronghold, besieged by bloodthirsty Nazcans. The greatest of the giant psychics came up with a desperate escape plan: using their powers, they burrowed deep into the mountain side, miles into the sheer rock, and fashioned an enormous underground complex. While the bulk of the Red People took refuge there, a sacrificial rear guard made a last stand against the Nazcans, dying to the man, but causing the stronghold to collapse, sealing the escape tunnel and convincing the Nazcans that the Pucara were no more.

The Red People now refer to the Nazca as the “sun stealers,” because they pushed the giants underground to hide in holes, depriving them from the pleasure of living under the sky and enjoying the warmth of the sun for millennia. Secure in their underground lair, the Pucara remained in hiding, terrified that if they were found, the humans would finish what they started. They were not to see the sun until the Great Cataclysm, when an earthquake collapsed an exterior wall and revealed the chaos outside. Despite having lived peacefully among themselves for centuries, the Red Giants had long memories. A few of their oldest leaders remembered the days of their childhood, when their kind had been slaughtered and forced into the darkness. Their words inspired a desire for revenge. Once again, “the People” split into factions. The greatest number wanted to go outside, reclaim their ancient holdings and extract bloody vengeance. Others counseled prudence and caution, to stay inside the mountains where it was safe. A third faction wanted to go outside, but pursue a peaceful existence.

The hostile group acted first, dispatching small bands of giants to kill every human they could find. These bloodthirsty warriors built hidden fortresses in the highest peaks and mountains. The Incas were also hated and seen as the heirs of the Nazca, and therefore, just as responsible for the “crimes” against them. Consequently, the hated Nazcas and the Empire of the Sun face the giants’ most terrible wrath and suffer their worst atrocities. The Pucara are so adept at hiding themselves that nobody has a good guess as to how many of the giants exist, or where their strongholds lie. Worse, the giants are the masters of the mountains, and know where every other nation and culture is gathered. Not even the mysterious City of the Dead is a secret from them (they know its location, but have done nothing against it, realizing rightly that the undead hate humans as much as the Pucara do and are engaged in their own campaign to destroy them — a worthy cause).

The Pucara attack the Arkhons and the Megaversal Legion in addition to the native humans. Their raids sometimes reach the lands of Santiago and Cordoba. Through these raids, the Red Giants have acquired a number of high-tech weapons, although

they do not have any means to keep them in repair or supplied, except by stealing more. Over the years, the creatures have amassed large arsenals of technological weapons, which they use in addition to their psionic powers.

For the moment, the giants have ignored many D-bee tribes and clans, unless they associate with humans. Those who befriend humans are slaughtered at their side! The Pucara have not yet sought the alliance of other, non-human beings, but this is a possibility in the future, particularly if that potential ally is a race of giants.

Pucara Red Giant R.C.C.

The Pucara are giant humanoids, averaging 20-24 feet (6.1-7.2 m) tall. Their skins are bright scarlet and hairless, and their bodies are broad-shouldered and heavily muscled. Their faces have very small noses, with six long but thin, slitted eyes arranged in a semi-circle. Their mouths are thin slits, and their faces are narrow and vaguely skull-like. Little knobs and spines are arranged around the head and cheeks. The Pucaras muscle structure is different than humans', making the creatures appear somewhat lanky, even gawky. The giants are incredibly strong and able to powder granite between their fingers; they are easily capable of crushing a human with a careless swat.

The Red Giants do not depend solely on their great physical strength. All Pucara are master psionics, with the unique ability to manipulate rock, making it flow like melted wax and reshaping it at will. The Pucara can hide beneath rock and emerge from it like an amphibious predator leaping out of water. Time after time, their powers have allowed them to ambush the most careful and watchful human warriors, and then they slip away, literally into the mountain, and disappear. Their most powerful psychics are trained in special monasteries to become the greatest warriors and mystics (see the **Pucara Mind Mage O.C.C.**, below); fortunately they are a comparatively small group within the Pucara race.

It is important to note that not all the Pucara seek to destroy humans. Many just wish to be left alone (most of these remain underground and avoid contact with surface beings). A small percentage have returned to live on the surface and enjoy the sun and the wind, and have made a valiant effort to befriend humans and other races. So far, these non-hostile Pucara have only managed to make friends with individual members of other races. The depredations of their murderous brethren have made most humans suspicious or hateful towards all Red Giants. This has also led to tragedy, as a number of peace-loving giants have been slain by frightened or vengeful humans who regard all Pucara as evil monsters.

All Red Giants are trained for war; the threat of humanity has kept the entire race prepared for war for thousands of years, and most of the giants are itching to use their skills in combat. Typical Pucara war bands have 3-12 (3D4) warriors, often supported by one or two Pucara mind mages.

Alignment: Any, but most revenge-minded Pucara are aberrant, miscreant or diabolic.

M.D.C.: 1D6×100 plus P.E. attribute. Add 10 M.D.C. per level of experience.

Attributes: I.Q.: 3D4+8, M.E.: 3D4+12, M.A.: 3D6, P.S.: 4D6+24, P.P.: 3D6, P.E.: 3D6+10, P.B.: 2D6, Spd.: 2D4×10

Size: 20 to 24 feet (6.1 to 7.2 m).

Weight: 3,000-4,000 pounds

Horror Factor: 11

Average Life Span: Average of 600 years, but a small percentage (less than 1%) somehow live ten or twenty times as long as normal. Some of the longest-lived Red Giants have lived for over 10,000 years. This appears to be a mutation that also renders such characters sterile after their first 800 years of existence.

Experience Level: Varies. Average NPC is 1D4+2. Player characters start at the first or second level.

Natural Abilities: Superior nightvision (can see in total darkness and in the infrared spectrum, to a range of 2000 feet/610 m), does not need air to breathe or eat (can survive underwater or even in the vacuum of space), getting energy instead from ambient P.P.E. (which means in a low P.P.E. environment on another world, their psionic and natural powers are reduced by 25%), rapid healing (4D6 M.D.C. per hour of rest), immune to mind control and possession, and highly resistant to magic.

Stone Powers: The Pucara have the ability to psionically manipulate rock and stone. By spending 10 I.S.P., the character can reshape up to 20 pounds (9 kg) or a two foot (0.6 m) section of stone or rock per level of experience. The stone can be remolded in any shape the Pucara wishes it to, but the process is long and takes about one minute per 20 pounds (9 kg) of rock. Or the character can greatly speed the process by spending 30 I.S.P. and turning a similar amount of stone into a semi-liquid substance. If this is beneath the feet of an enemy, the victim will sink in the liquid stone unless he can dodge (must roll a 16 or higher). The Pucara can then cause the stone to harden, trapping the victim until 10 M.D. is inflicted on the rehardened stone. A favorite Pucara ploy is to create a hole on the side of a mountain, hide in it and re-cover it with stone, and when the enemy passes by, cause the stone to turn liquid and spring into ambush! Only a detect ambush roll at -50% will detect such a hiding spot.

Telekinetic Stone Missiles: As long as the Pucara have rocks and stones handy, they do not lack for missile weapons. The Red Giants can cause rocks to strike at incredible speeds. The telekinetic powers not only launch the rocks, but temporarily surround them in an M.D.C. energy field that allows them to inflict mega-damage. The rocks will fly out of or off the ground towards the target. By making a called shot, the Pucara can have a rock leap from anywhere within 30 feet (9.1 m) of him to strike. This attack can also be used to strike an unsuspecting foe from behind (no dodge possible). The telekinetic stones are at +3 to strike and inflict 4D6 M.D. at level one; add 1D6 M.D. at levels three, five, seven, nine, eleven, thirteen and fifteen. This power costs 4 I.S.P. per "shot" and has a range of 1000 feet (305 m); each "shot" counts as one melee action.

Strengthen Molecular Bonds: By using this power, the Pucara can manipulate stone at the molecular level, making stone ultra-hard. The character can actually transform ordinary stone into M.D.C. materials using this power! All Pucara weapons, armor and fortresses are made of stone strengthened in this way. The power is expensive and time consuming, tak-

ing 30 I.S.P. and 1D6 hours per pound (0.45 kg) of stone, but once the process is finished, the material is super-strong, able to hold an edge like metal and able to inflict and sustain mega-damage.

Combat: As per hand to hand skill.

Damage: As per supernatural P.S.

Bonuses: +4 to save vs magic, +5 to save vs horror factor; all in addition to attribute and skill bonuses.

Magic Powers: None, and never learn any. The Pucara are natural, master psionics and rely entirely on their natural powers;
P.P.E.: 2D4+4

Psionic Powers: Considered to be a master psionic. Select two powers from each of the sensitive, physical and healing categories. At every level after the first, select one additional power from any of those three categories per level of experience. Their special psionic stone powers take the place of super-psionic abilities.

I.S.P.: 2D6×10 plus M.E. attribute number, and 3D6 I.S.P. per level of experience.

Vulnerabilities/Penalties: None.

R.C.C. Skills:

Language and literacy: Pucara (98%)

Language: one of choice (+15%)

Basic math (+15%)

Climbing (+10%)

Detect concealment (+10%)

W.P. Blunt

W.P. Sword

W.P. two of choice

Hand to Hand: Expert

Hand to Hand: Expert can be changed to Hand to Hand: Martial Arts or Assassin at the cost of one "other" skill.

R.C.C. Related Skills: Select eight other skills. Plus select one more skill at levels three, five, seven, ten, twelve and fourteen. All new skills start at level one proficiency. Most Pucara do not learn many technologically oriented skills, but a few have managed to learn some basics.

Communications: Basic radio only.

Domestic: Any (+10%)

Electrical: None.

Espionage: Wilderness survival, tracking, camouflage and detect ambush only.

Mechanical: Any

Medical: Holistic medicine only.

Military: None.

Physical: Any except acrobatics.

Pilot: Any

Pilot Related: Any

Rogue: Any (+2%), except computer hacking.

Science: Any

Technical: Any (+10%)

W.P.: Any

Wilderness: Any (+5%)

Secondary Skills: The character also gets to select six secondary skills. These are additional areas of knowledge that do not get the benefit of the bonuses listed in parentheses. All secondary skills start at the base skill level. Also, skills are limited (any, only, none) as previously indicated in the list.

Alliances and Allies: None at this time. Most Pucara are at war with humans and distrust all other humanoids, or are hiding from all other races on the planet.

Weapons: Typical Red Giant weapons include giant stone axes (3D6 M.D. plus P.S. damage) and hammers (4D6 M.D. plus P.S. damage). Many giants (40%) have one captured energy weapon and 1D4 spare E-clips for it.

Body Armor: Plate armor made of solid stone (150 M.D.C.) or lighter half plate (90 M.D.C.); both weigh well over a hundred pounds (45 kg).



Pucara Mind Mage O.C.C.

The Pucara Mind Mage is a powerful psychic, trained in special schools to be the best combination of warrior and mystic possible. These powerful warriors not only have the powers and skills common to all Pucara, but also have super-psionic powers. Typically, there are only a handful of these psychics in any Pucara stronghold (one in one hundred), and rarely more than one in a war band, unless the group is after a very important goal. Many mind mages become chieftains or even kings, and killing or injuring them is considered to be the ultimate offense against the entire race.

O.C.C. Abilities and Bonuses

1. R.C.C. Powers: Pucara Mind Mages have all the powers and bonuses of the Pucara race described previously.

2. Enhanced Psionic Powers: At first level, the character can select three powers from each of the three categories, and two from the super-psionic category. Every level after the first, the character can select an additional two powers from *any* category. Restrictions that apply to mind melters also apply to these characters.

3. Enhanced I.S.P.: 4D6×10 plus M.E. attribute number. Add 15 I.S.P. per level of experience.

Attribute Requirements: M.E. 15 or higher.

O.C.C. Skills:

Language and literacy: Pucara (98%)
Language: one of choice (+15%)
Basic math (+15%)
Climbing (+10%)
Demon and monster lore (+10%)
Detect concealment (+10%)
W.P. Blunt
W.P. Sword
W.P. two of choice
Hand to Hand: Martial Arts

R.C.C. Related Skills: Select nine other skills. Plus select two more skills at levels three and six, and one at levels eight, ten, twelve and fourteen. All new skills start at level one proficiency. Most Pucara do not learn many technologically oriented skills, but a few have managed to learn some basics.

Communications: Basic radio only.
Domestic: Any (+10%)

Electrical: None.

Espionage: Wilderness survival and detect ambush only.

Mechanical: Any

Medical: Holistic medicine only.

Military: None.

Physical: Any, except acrobatics.

Pilot: Any

Pilot Related: Any

Rogue: Any, except computer hacking.

Science: Any

Technical: Any (+10%)

W.P.: Any

Wilderness: Any (+5%)

Secondary Skills: The character also gets to select six secondary skills. These are additional areas of knowledge that do not get the benefit of the bonuses listed in parentheses. All secondary skills start at the base skill level. Also, skills are limited (any, only, none) as previously indicated in the list.

Standard Equipment: Same as the Pucara R.C.C.

Weapons and Equipment of the Empire of the Sun

Most of the technology of the pre-Rifts nations of Peru and Bolivia was lost during the Great Cataclysm. A few energy weapons from that period have been hoarded and jury-rigged over the centuries, but the bulk of the Inca's technological weapons come from the city-state of **Arequipa**, or from trade with the D-Bee/Human nation of **New Babylon** (described under the *Silver River Republics*). A few other goods and products also come from other SRRs, including the nation of Santiago. The Empire is a big market for *Glitter Boy* power armor. Glitter Boys are

liked because they look like homages to the sun god, plus they are extremely efficient weapons.

Some Inca soldiers also use captured Arkhon weapons. Arequipa has one of the few factories where Arkhon weapons can be converted and retooled to accept Earth energy clips. The factory only works on captured weapons; the Peruvian scientists lack the technology to understand, let alone replicate, the alien weapon systems. See the **Arkhon Threat Section** for more information about the weapons and armor of these alien invaders.

Inti-10 Variable Laser Pistol

Just released by the factories of Arequipa, the Inti laser line is the pride of the Empire. The frequency of the laser beams can be changed which allows it to defeat laser-resistant armor like the Glitter Boy and similar alloys. Unfortunately, this weapon was developed as a countermeasure against Arkhon body armor, and in that regard, it is a failure (see the **Arkhon Threat section** for more information). Still, this serviceable pistol has been adopted as the Imperial armies sidearm of choice. The variable frequency laser system will defeat laser-resistant armor 1D4 attacks after the first hit.

Weight: 2 lb. (0.9 kg)
Mega-Damage: 2D4+2 M.D.
Rate of Fire: Standard.

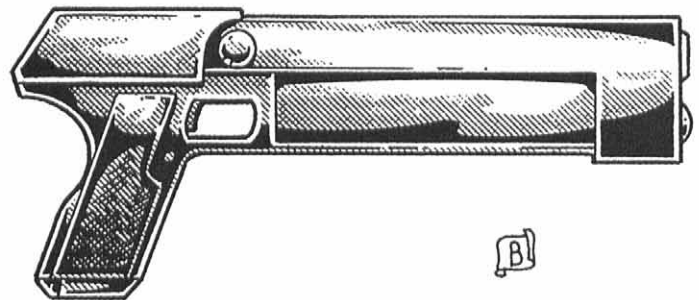

Effective Range: 1000 feet (305 m)
Payload: 10 shots.
Cost: 10,000 credits

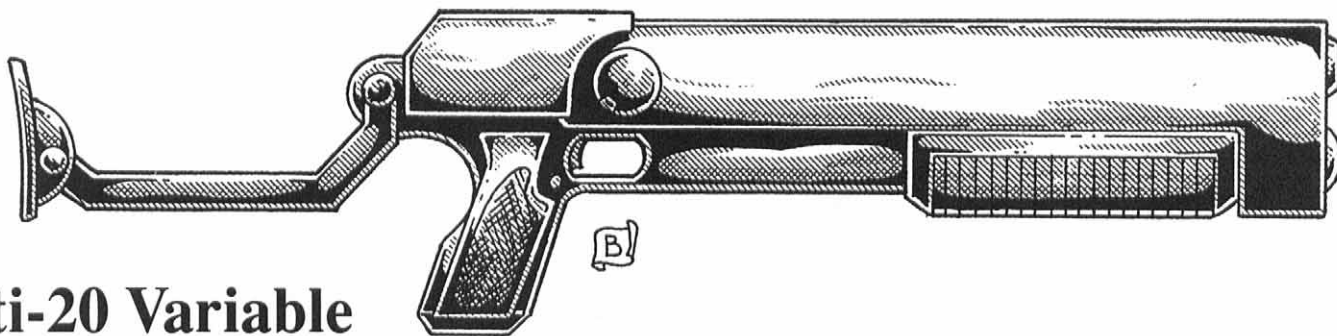

Inti-20 Variable Laser Rifle

A rifle version of the laser pistol, the Inti-20 is the standard issue long-arm of the Inca Army, equipping about 60% of the infantry (the other 40% use rocket rifles). The variable frequency laser system will defeat laser-resistant armor 1D4 attacks after the first hit.

Weight: 4 lb. (1.8 kg).

Mega-Damage: 2D6+6 M.D. per single shot or 1D4×10+10 M.D. for a triple pulse.

Rate of Fire: Standard.

Effective Range: 2000 feet (610 m)

Payload: 24 shots.

Cost: 18,000 credits.

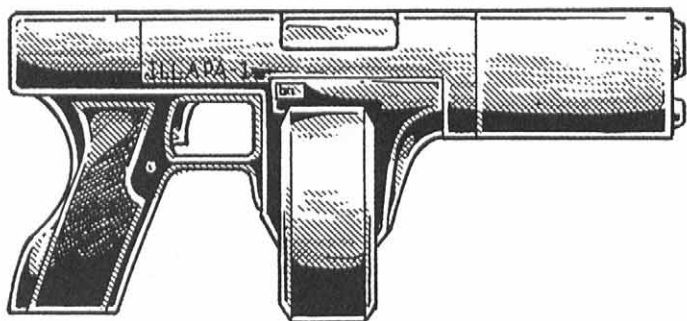

Illapa-1 Rocket Pistol

Named after the Inca thunder god, the Illapa fires 15mm explosive bullets. These fat pistol bullets (about half as thick as a .45 round) are fed from a drum magazine located in front of the trigger guard, making it a front-heavy and rather clumsy gun. The 15mm explosive rounds are comparable to lasers in terms of damage and penetration, however, and they work very well against Arkhon composite armor.

Weight: 5 lb. (2.25 kg).

Mega-Damage: 2D6+4 M.D. per shot.

Rate of Fire: Standard.

Effective Range: 600 feet (183 m).

Payload: 80 shots in drum magazine or 20 in a small clip.

Cost: 14,000 credits; each bullet costs 20 credits.

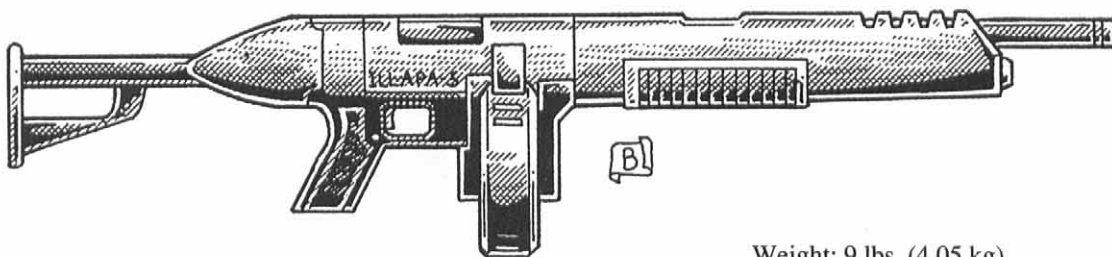

Illapa-5 Rocket Rifle

The Illapa-5 rifle fires 15mm "long" cartridges. These rifle warheads are longer and pack more punch than the pistol ammo, and have much better range. Like all Illapa weapons, the ammunition is carried in a drum magazine, somewhat similar to the magazine in the Thompson sub-machinegun (but the gun design is far different). Some 30-50% of the Inca troops are equipped with this weapon, especially when facing off the Arkhon aliens, whose armor is highly resistant to energy weapons.

Weight: 9 lbs. (4.05 kg).

Mega-Damage: 4D6 M.D. per shot. A three round burst does 1D4×10 M.D., and a 10 round burst inflicts 2D4×10 M.D.

Rate of Fire: Selective fire; single aimed shots, 3-round bursts, and 10-round bursts. The weapon has a disengage mechanism that prevents full-automatic fire (the gun stops cycling after 10 rounds have been shot and until the soldier releases the trigger and presses it again).

Effective Range: 2400 feet (731.5 m)

Payload: 60 shot drum magazine.

Cost: 26,000 credits

Gilded Body Armor

The pride and joy of the Arequipa armorers, Gilded Body Armor is designed for both looks and strength. The suit is reserved for officers, soldiers in crack assault units, and other elite forces. Gilded armor consists of solid metal plates and a helmet simulating the half-moon headgear of the Inca sun-god, Inti. The face-plate is sometimes sculpted with a face mask, and the armor can be decorated with fantastic designs and elements. Nazca line makers sometimes have magic patterns permanently inscribed in the armor (these patterns are destroyed when half the M.D.C. of the armor is depleted). The only defect of the armor is that it is somewhat cumbersome.

- 70 M.D.C.
- Weight: 21 lb. (9.5 kg).
- Fair to good mobility: -10% prawl penalty.
- Cost: 50,000 credits

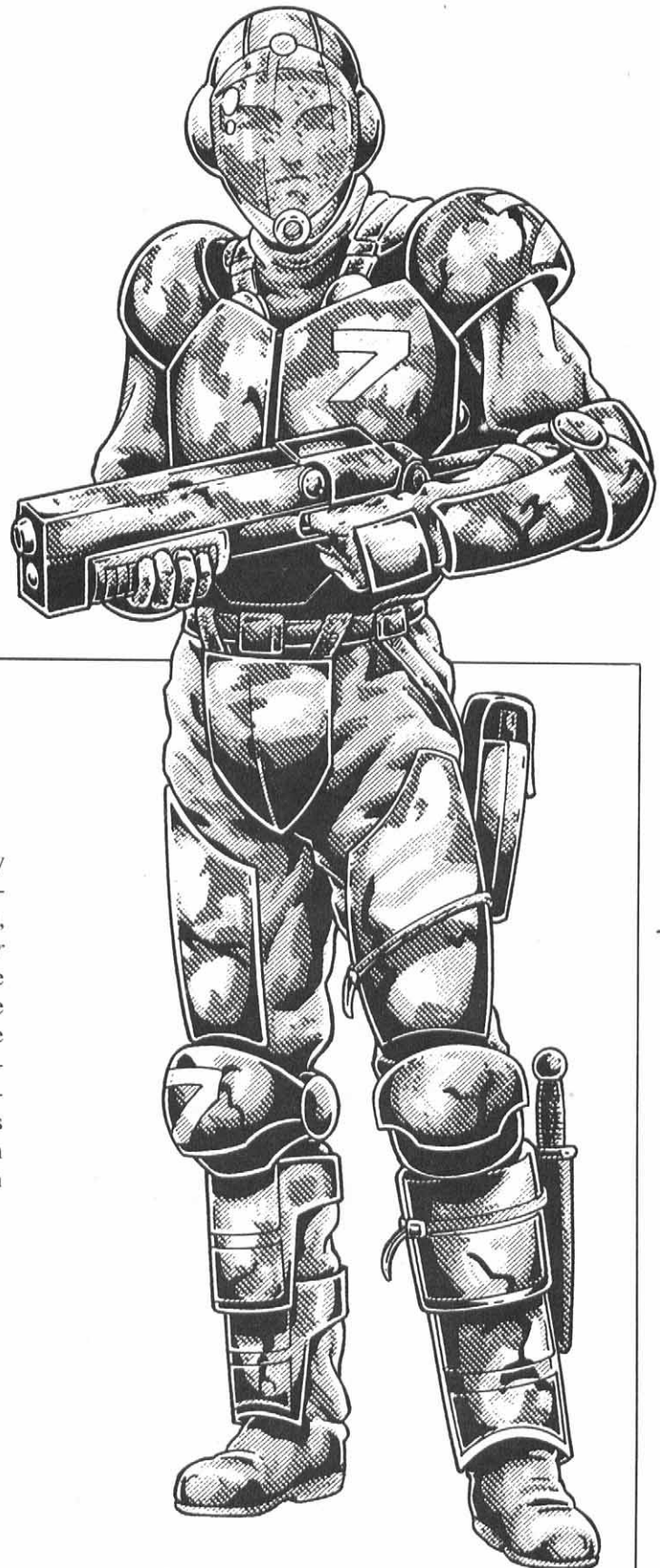

Sinchi Body Armor

Sinchi (“chieftain” or “warlord”) body armor is commonly worn by the rank and file of the Inca army. The armor is a serviceable military suit based on pre-Rifts Peruvian Army designs, and is somewhat similar to the North American *Urban Warrior* suit. The Sinchi is a jumpsuit with solid plates protecting the chest, forearms, thighs and shins. Articulated plates protect the elbows and knees, and a helmet with face-plate protects the head. The army issue is painted with mountain camouflage patterns (brown and black shades, designed to meld with the surroundings; jungle units use a green-black pattern). The suit is light and easily used and the favorite of priests and magicians in war zones; often repainted a colorful red or yellow, or with feathers attached to the helmet.

- 45 M.D.C.
- Weight: 10 lb. (4.5 kg).
- Good mobility: -5% prawl penalty.
- Cost: 25,000 credits.

Nazca Power Armor

This is a recent Inca-Nazca collaboration, in service for the last 5 years. Inca priests channeled some of the energies of the Pantheon of the Sun to permanently power the patterns imprinted on this metal and ceramic suit. The basic design of the suit is pre-Rifts Peruvian; an oversized, heavily armored suit meant to destroy Glitter Boys. Although the blueprints survived in the city of Arequipa, the technology to build and power this powerful model was lacking. The Incas and the Arequipan weaponsmiths collaborated on this creation, one of the few techno-wizard items in the Empire. Advisors from New Babylon also helped with the engineering. The result was a suit of power armor, powered entirely by magic!



The armor is humanoid, with overlapping curved plates, most of them triangular or spiked, which give the armor a vaguely demonic look. The head has a central “V” plate that extends beyond the head like a set of horns. The suit has no apparent eyes, because the Peruvian designers had decided to rely on fiber-optic multiple visual sensors distributed in three “bundles” on the armor. This makes it impossible to blind the armor by destroying

the head. V-shaped forearm blades were designed to have vibro-energy fields, but the Peruvians could not replicate this technology; however Nazca magic makes the blades even more effective.

The pilot is inside the torso, safe even if the robot head is destroyed. The suit's size makes the pilot's compartment very cramped. The pilot sits with his knees drawn up towards the body, and the armor is designed for soldiers less than six feet (1.8 m) tall; most Inca soldiers are 5'8 to 5'10 (1.7 to 1.75 m), so they can endure the conditions without much trouble. Taller pilots will be extremely uncomfortable: more than two hours in the compartment will be painful and distracting (reduce all combat bonuses by -2 after two hours); the maximum height for use with this armor is 6'4 (1.9 m).

The original design called for the use of the most advanced M.D.C. materials available on pre-Rifts Earth, alloys that only the NGR has access to in the post-apocalyptic years. The best the Arequipans could come up with was a suit of "soft" M.D.C. materials, large and heavy but with less protection than a much smaller suit. However, this offers adequate protection until the magic of the suit can be activated and the armor's mega-damage capacity is dramatically increased.

Inscribed on the armor are a number of Nazca line patterns. When activated, a skin-tight energy field surrounds the suit, strengthening its structure and turning it into a super-hard magical alloy, highly resistant to conventional weapons. The power armor can be magically "empowered" with a simple verbal command form inside the suit. However, this magical energy reserve has its limitations. The magically enhanced armor is only available for a total of eight hours a day (24 hour period). This means the pilot should not squander the power and use it only when going into certain battle. Once activated, the extra protection will remain until turned off. When reactivated, it will heal any damage from earlier battles. Once all of the magic mega-damage has been depleted, the physical armor becomes vulnerable to attack and destruction. The armor does, however, automatically regenerate to maximum M.D.C. at the beginning of every new 24 hour period. **Note:** The main pattern energizes the suit, allowing the wearer to move and fight with supernatural strength and speed. Other line drawing magic makes the forearm blades lethal slashing, mega-damage weapons. Finally, the suit can fire blasts of pure ley line energy from its hands.

Not all the weapon systems of the suit are magical. The Nazca Power Armor is equipped with a two-stage rocket rifle. The rifle uses a small charge to fire the rocket out of the gun; the rocket's own engines fire up some ten yards away (30 feet/9.1 m), propelling the weapon at the speed of a mini-missile, although for a shorter distance. The rockets are laser-guided; the rifle has laser sights, and the rocket flies towards the target illuminated by the crosshairs. The problem is that the crosshairs are visible to the naked eye; one's opponent can see a small red dot appear on him, and knows that he has been targeted. This drawback can be an advantage if the purpose is to intimidate rather than destroy. Mounted below the rocket rifle is a slender machinegun used against enemy infantry or lightly armored vehicles. Other weapons include a conventional missile launcher mounted on the back (inspired by the "backpack launchers" used by the Arkhons).

In the five years since its adoption, the Nazca PA has proved itself against the Arkhon Death Cyclops and Stormwind suits. The Nazca is easily the match for half a dozen Stormwinds, and can fight against the Death Cyclops one-on-one. The power armor's supernatural strength enables it to tear through even the

Death Cyclop's thick armor, so the Arkhons have learned to fear it in hand to hand combat situations. The aliens' tactic is to avoid closing in, and instead, overwhelm the suit with ranged or indirect (mortar) fire. The suit's inability to fly also makes it vulnerable to both the Stormwind and the Ghost Wasp, which can attack it from the air. Overall, however, this armor is one of the mainstays of the Inca Army.

The great cost in both industrial and magical manpower has limited the number of Nazca PAs in manufacture. Currently, only 100 of these suits are produced every year; there are some 250 suits in service; 65 have been destroyed, and 30 or so are missing, assumed to have been captured or destroyed. The Arkhons are known to have five or so captured suits; they are trying to understand its mechanisms, but their lack of magical knowledge severely hampers their research.

Model Type: NPA Mark I

Class: Heavy Armored Infantry Assault Suit

Crew: One

M.D.C. by Location: Attributes in parentheses apply when the suit is not powered up or when the first number has been depleted. The number in parentheses is the M.D.C. of the actual suit when not magically enhanced. The higher number is the magic M.D.C. that is available at the beginning of every new day for a maximum of 8 hours. Once the magical M.D.C. is depleted or the time limit reached (and the magic protection turns off), damage comes off the number in parentheses.

Arms (2) — 240 each (80 each when not magically energized)

Rocket Rifle/Machinegun — 120

Legs (2) — 300 each (100 when not energized)

Missile Launcher (1, on back torso) — 100

Head — 250 (90 when not energized)

* Main Body — 600 (200 when not energized)

* Depleting the M.D.C. of the main body will cause the robot armor to completely disintegrate. **Note:** The suit does not appear to suffer apparent damage until reduced to below the M.D.C. listed in parentheses! This is one of the features of the magic and serves to create the illusion that the enemy is inflicting little or no damage.

Speed

Running: 60 mph (96 kmph) maximum. The act of running does not tire the operator.

Leaping: The powerful robot legs can leap up to 30 feet (9.1 m) high or across.

Flying: Not possible.

Statistical Data:

Height: 11 feet (3.3 m)

Width: 6 feet (1.8 m)

Length: 4 feet, 6 inches (1.4 m)

Weight: 1.3 tons fully loaded

Physical Strength: Equal to a P.S. of 35 (supernatural, not robotic).

Cargo: None.

Power System: Magical; the suit's energies need to be replenished every five years.

Market Cost: Not for sale! Only troops loyal to the Empire of the Sun (Inca Warriors, regular Inca soldiers, etc.) will be issued these rare and valuable suits. Stolen/captured suits sold on the black market would cost upwards of 10 million credits; their magical energy life will only last 1D4 years.

Weapon Systems

1. Rocket Rifle/15mm Machinegun: This oversized rifle is an over-and-under design. The upper gun is a 60mm rocket launcher that fires laser-guided missiles (less complex and shorter-ranged than common mini-missiles). Eight rockets are in an oversized vertical magazine on top of the gun. The lower, smaller gun is a 15mm machinegun firing explosive bullets, an oversized version of the Illapa rifle, fed from a big drum magazine in front of the trigger. The rocket system is fired by a small charge from the rifle and then ignited in the air (eliminating the need for a backblast tube). As he fires, the shooter has to keep the laser crosshairs on the target; for targets less than 600 feet (183 m) away, this takes effectively no time (one melee attack). Targets beyond 600 feet (183 m) need two melee rounds of aiming before the rocket gets to them.

Primary Purpose: Anti-armor, anti-personnel.

Secondary Purpose: Defense.

Mega-Damage: **Rockets:** Explosive warheads inflict 1D6×10 M.D. to a 3 foot (1.0 m) area. Fragmentary warheads do 5D6 M.D. to a 20 feet (6.1 m) area. **Machinegun:** A burst is 10 rounds and inflicts 2D4×10 M.D. Can only fire bursts.

Rate of Fire: Equal to the combined number of hand to hand attacks of the pilot.

Effective Range: 2000 feet (610 m) for both weapons.

Payload: Rockets: 6 in magazine; two additional magazines can be clamped to the sides of the suit.

Machinegun: Oversized drum magazine has 300 rounds (30 bursts). A spare can be clamped in back, below the back-mounted missile launcher (see below). Changing magazines counts as one melee action/attack.

2. Short-Range Missile Launcher: To counteract the Arkhons' superiority in artillery and mortars, the Nazca PA is supplied with a backpack launcher and eight short-range missiles. These missiles can be targeted by forward observers to hit targets beyond the sight of the pilot. They are also the best weapon system to deal with flying robots and the Arkhon attack fliers.

Primary Purpose: Bombardment, anti-aircraft.

Secondary Purpose: Defense.

Mega-Damage: Varies with missile type, typically 1D6×10 or 2D4×10.

Rate of Fire: One at time, or in volleys of two or four missiles.

Effective Range: 1-3 miles (1.6 to 4.8 km).

Payload: Eight missiles.

3. Energy Blasters: There are no visible weapon mounts for these blasters because they are magic in nature; an extension of the same energies that keep the armor suit powered up. These energy blasts are used as backups for when the ammo of the other weapon systems is used up.

Primary Purpose: Anti-armor, anti-personnel

Secondary Purpose: Defense.

Mega-Damage: 5D6 M.D. per blast.

Rate of Fire: Equal to the number of hand to hand attacks of the pilot.

Effective Range: 1000 feet (305 m)

Payload: Effectively unlimited.

4. V-Blades: The forearm slashing blades are surrounded by the same energy field that strengthens and energizes the suit. As long as the energy field is on, the blades inflict 3D6 M.D. in

addition to the suit's supernatural P.S. damage (for a total of 7D6 M.D.). When the suit is reduced to 200 M.D.C. or less, the blades only do 3D6+4 M.D.

5. Hand to Hand Combat: Rather than use a weapon, the pilot can engage in mega-damage hand to hand. See Power Armor Combat training (*Rifts RPG*, page 44) for more information.

Mega-Damage:

Punch: 4D6 M.D. Kick: 5D6 M.D.

Power Punch: 1D4×10 M.D. (counts as two attacks)



Armor of the Sun

This is not truly a suit of power armor, but a holy talisman of the Pantheon of the Sun which, when activated, encases the wearer in a flaming golem-like creature! This magical item is not mass-produced; the gods of the pantheon have created about 100 amulets, all of which are in the hands of loyal Inca Warriors, demigods, or other champions. The strength and power of the armor are directly linked to the willpower and mental endurance (M.E.) of the wearer; the stronger the will of the wielder, the stronger the suit.

The amulet is a golden medallion, fashioned like a spiked sun. The wearer can activate it by touching the medallion and concentrating (takes one melee action). An instant later, the character has been replaced by a huge golden figure, humanoid, with a broad back, thick limbs, and an Inca helmet seemingly sculpted into its head. The figure appears to be burning, but the flames never consume it, just extend all around him like the corona of a star. While inside the construct, the "pilot" can see through its eyes and use all of its senses. The armor of the sun is

NOT a technological suit of power armor, however; it has none of the special sensors, communication systems and other gear commonly found in such suits. Instead, it has several magical powers and abilities.

Among other things, the armor of the sun can fly, run at great speeds, and shoot searing bolts of magical plasma. It is totally immune to fire and highly resistant to energy attacks. The armor can be made to shine with a blinding, searing intensity, able to harm vampires and other creatures of the night. The armor's very touch can melt iron and cause flammables to ignite. The supernatural strength of the construct can threaten mega-damage creatures and vehicles that can resist the flames.

The armor's wearer can wear any sort of personal armor, but not power armor or exoskeletons. When the effect is over or the sun armor is destroyed, the wearer appears in its stead. The amulet can be activated up to six times a day, and each activation can last up to two hours. If the armor is destroyed, it cannot be reactivated for 24 hours, but it does regenerate to full M.D.C. by the end of that time. **Note:** Any damage suffered by the suit carries over from activation to activation so canny characters cannot deactivate and activate the armor to get a brand new suit.

Model Type: SOL-I **Class:** Magical Construct Assault System

M.D.C. by Location: The M.D.C. of the Sun Armor is determined by the Mental Endurance (M.E.) of the wearer. There is a limit to the armor, however, regardless of how strong the will of the wearer is; this limit is listed in parentheses.

Arms — M.E. x10 (Maximum 250)

Legs — M.E. x15 (Maximum 375)

Crew: One

Head — M.E. x10 (Maximum 300)

* Main Body — M.E. x20 (Maximum 600)

* Depleting the M.D.C. of the main body shuts down the enchantment, causing the armor to disappear. The wearer, clad in his normal clothing/body armor, will appear where the construct stood, unharmed but now vulnerable to attack. The armor is not available again for 24 hours after its destruction!

All components of the armor heal at the rate of 1D6x10 M.D. per hour. Deactivating and activating the armor does NOT bring back a brand-new suit of armor; damage is constant until it regenerates (the regeneration continues whether or not the suit is active, however).

The armor takes no damage from flame attacks, including plasma and magical fire, and takes half damage from energy attacks.

Speed

Running: 100 mph (160 kmph) maximum. The act of running does not tire the operator; the armor's magical power provides all the energy.

Flying: 200 mph (320 kmph) maximum.

Range: Limited only by the number of activations (12 hours a day total), for a maximum range of 2400 miles (3840 km) per day. Maximum flying altitude is limited to 15,000 feet (4572 m).

Statistical Data

Length: 3 feet (0.9 m)

Height: 7 feet (2.1 m)

Weight: 800 lbs. (362.4 kg).

Physical Strength: P.S. 40 (supernatural)

Width: 4 feet (1.2 m)

Cargo: None; clothes, body armor and carried weapons disappear when the armor is activated, and reappear afterwards.

Power System: Magical; needs to be magically recharged (1,000 P.P.E.) every two years.

Market Cost: Never sold by the Empire of the Sun; a stolen amulet could cost as much as 10+ million credits.

Weapon Systems

1. Fiery Aura: The suit is surrounded by flames that can be extended up to 6 feet (1.8 m) away from the suit. The power is usually only activated when the suit is flying, or the armor would melt and scorch the very ground around it. Incoming enemy missiles take damage from the aura before striking the character; if the damage is enough to destroy them, the armor only takes half damage!

Primary Purpose: Defense

Secondary Purpose: Anti-personnel

Mega-Damage: Anything coming into range of the field of flames takes 4D6 M.D.

Rate of Fire: Always on, damage occurs instantly; if the object/person remains in the field of effect, it/he will take 4D6 M.D. every 5 seconds (12D6 M.D. or 1D6x12 M.D., after a full melee round!).

Effective Range: 6 feet (1.8 m).

Payload: Unlimited.

2. Flame Blasts: The suit can fire fiery blasts from its hands or eyes. Damage can be adjusted in increments of 1D6 M.D.

Primary Purpose: Anti-armor

Secondary Purpose: Defense.

Mega-Damage: 1D6 M.D. to 1D6x10 M.D.

Rate of Fire: Equal to the number of hand to hand attacks of the pilot.

Effective Range: 2000 feet (610 m)

Payload: Effectively unlimited.

3. Blinding Aura: The suit can increase its brightness until it dazzles anyone in the area of effect. People looking directly at the suit will be blinded unless they roll a saving throw of 16 or higher (-8 to strike, parry and dodge for 1D6 melee rounds). Characters with polarized helmets, goggles, etc., need to roll a 13 or higher to save vs the blinding effects, and even then they are at -3 to all attacks for 1D4 rounds. Targets inside power armor and robots suffer no ill effect.

Primary Purpose: Anti-personnel

Mega-Damage: None, except vampires (-3 to save vs blindness and suffer 2D6 damage per melee round exposed to the light).

Rate of Fire: Equal to the number of hand to hand attacks of the user; typically never used more often than once per round.

Effective Range: Area bathed by light can be adjusted in 10 foot (3.0 m) increments, up to a radius of 200 feet (61 m).

Payload: Unlimited.

4. Magical Systems: The suit does not have radar, radio or other normal features of armor. However, its magic can replace many systems:

Environmental System: The armor protects the wearer from all extremes of temperature, gases, toxins and hostile environment.

Sensors: The suit can see the invisible and sense magic (range 2000 feet/610 m).

Communication: The suit can send telepathic messages to a psychic or magician (including priests and True Incas) up to one mile (1.6 km) away.

5. Hand to Hand Combat: Rather than use a weapon, the pilot can engage in mega-damage hand to hand combat. Use the following bonuses rather than the standard Power Armor Combat bonuses:

- One hand to hand attack per melee (plus those of the pilot)
- +2 to strike and parry, +1 to dodge, +2 to dodge when flying,

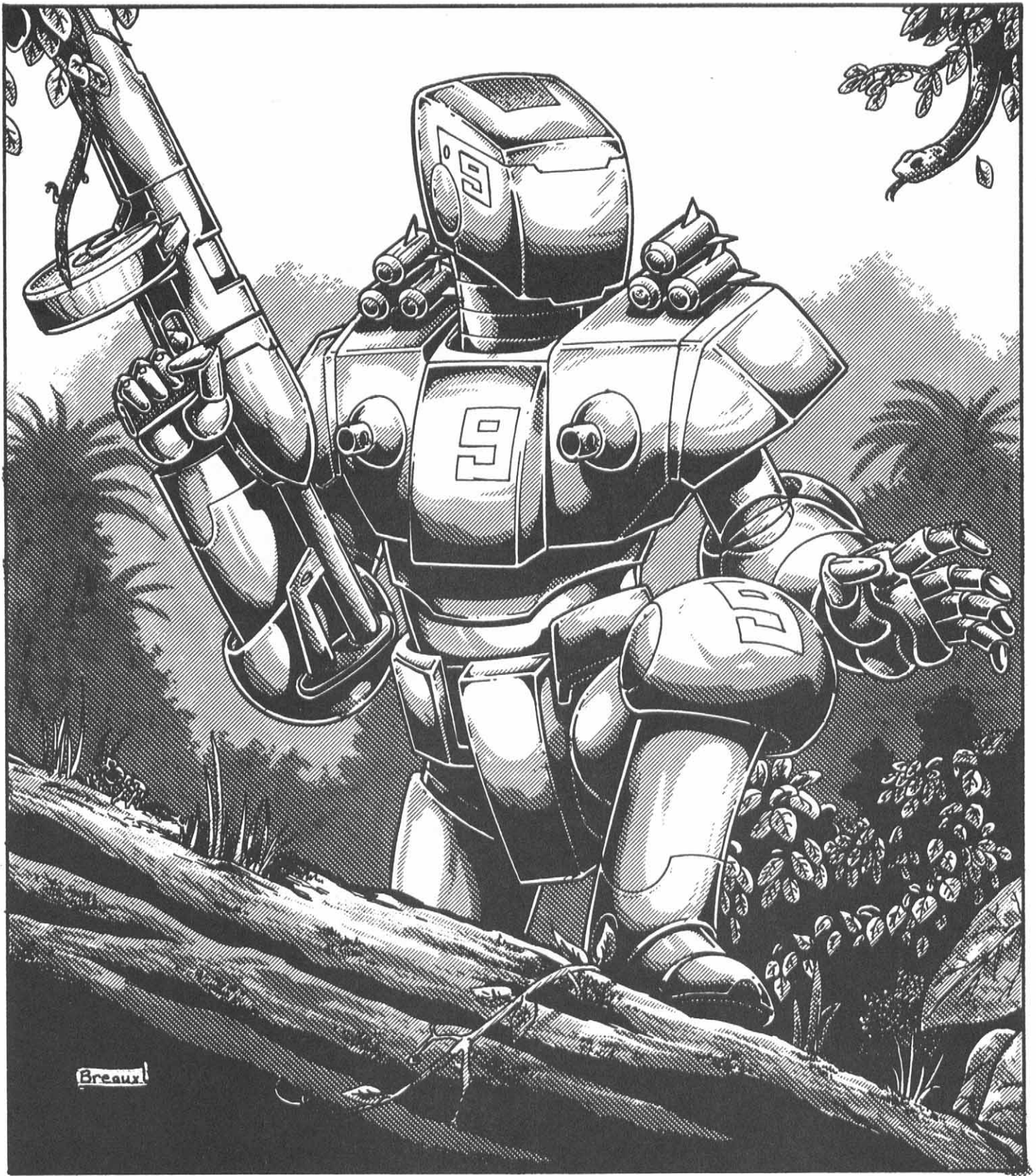

- +2 to dodge with punch, fall or impact.
- Add an additional melee attack at levels six and twelve.

Mega-Damage:

Punch: 5D6 M.D.

Power Punch: 1D6×10 M.D. (counts as two attacks)

Kick: 6D6 M.D.

Leap Kick: 1D6×10+6 M.D. (counts as two attacks)

Atahualpa Combat Suit

This simple power armor was the first working model developed by the armorers of Arequipa, and it has had over two centuries of service. Its simplicity, sturdiness and relative cheapness have continued to make it the most commonly produced suit of armor in the Empire. Over 5,000 of these suits are still in mili-

tary service, and thousands more are in the hands of local militias and volunteers.

The Atahualpa is a fully sealed suit of armor with no apparent eyes. The head/helmet is nearly featureless (the sensors are hidden in a manner similar to a two-way mirror), and it is rather square and unattractive. The torso armor is a solid, broad-shouldered, central block; a flexible, thin middle joins the torso to a smaller block protecting the pelvis/hip area. The arms and legs are relatively thin, but the elbows and knees are big, round, almost cartoonish-looking, as are the feet and hands. Three mini-missiles are mounted over each shoulder. As a primary sidearm, the pilot carries an oversized version of the Illapa rifle, with a much larger drum magazine. Two chest guns fire conventional S.D.C. 12mm bullets, or can fire explosive rounds to act as a back-up.

Model Type: AC-1

Class: Infantry Combat Exoskeleton

Crew: One

M.D.C. by Location:

Illapa Giant Rifle — 120

Arms (2) — 80 each

Mini-Missile Launchers (2, on shoulders) — 60 each

Legs (2) — 120 each

* Head — 60

** Main Body — 200

* Destroying the head of the power armor will eliminate all forms of optical enhancements and sensory systems. The pilot is forced to rely on his own human vision and senses. All power armor combat bonuses are lost. Hitting the head requires a called shot at -3 to strike.

** Depleting the M.D.C. of the main body will shut the armor down completely, making it useless.

Speed

Running: 50 mph (80 kmph) maximum. Note that the act of running does tire out the operator, but at 30% of the usual fatigue rate thanks to the robot exoskeleton.

Flying: Not possible.

Statistical Data

Height: 8 feet (2.4 m)

Width: 6 feet (1.8 m)

Length: 4 feet (1.2 m)

Weight: 1,200 lb. (544 kg)

Physical Strength: Equal to a P.S. 30

Cargo: None.

Power System: Nuclear; average energy life is 10 years.

Market Cost: 1.5 million credits

Weapon Systems

1. Illapa Giant Rifle: This is a standard Illapa rifle, but with larger handles to allow the power armor to use it, and a larger drum magazine.

Primary Purpose: Assault

Secondary Purpose: Defense.

Mega-Damage: 4D6 M.D. per shot. A 3-round burst does 1D4×10 M.D., and a 10-round burst inflicts 2D4×10 M.D.

Rate of Fire: Selective fire; single aimed shots, 3-round bursts, and 10-round bursts. The weapon has a disengage mechanism that prevents full-automatic fire (the gun stops cycling after 10 rounds have been shot and until the soldier releases the trigger and presses it again).

Effective Range: 2400 feet (731.4 m)

Payload: 600 round magazine; that's 60 ten round bursts.

2. Mini-Missile Launchers (2): These mini-missile launchers are fed from internal magazines, allowing the power armor to launch several volleys of up to six missiles before running out of ammo. Often, each launcher is loaded with a different type of missile to allow for a variety of missions.

Primary Purpose: Varies with missile type.

Secondary Purpose: Defense.

Mega-Damage: Varies with missile type.

Rate of Fire: One at a time or in volleys of three or six missiles.

Effective Range: About one mile (1.6 km).

Payload: 18 total; 3 in each launcher and six more in integral magazine, for 9 per launcher.

3. Chest Guns: These guns fire 12mm bullets, used against S.D.C. targets. The gun can also be loaded with explosive rounds that enable it to damage M.D.C. targets.

Primary Purpose: Anti-personnel

Secondary Purpose: Defense.

Mega-Damage: Standard rounds: 2D6×10 S.D.C. (1 M.D.) per burst of 10 rounds or 4D6×10 S.D.C. (2 M.D.) per simultaneous double burst from both guns (counts as one melee attack). Explosive rounds: 2D6 M.D. per burst of 10 rounds or 4D6 M.D. per simultaneous double burst from both guns (counts as one melee attack). Can only fire bursts.

Rate of Fire: Each burst counts as one attack per melee.

Effective Range: 3000 feet (915 m)

Payload: 2000 rounds per gun; that's 200 bursts.

4. Hand to Hand Combat: Rather than use a weapon, the pilot can engage in mega-damage hand to hand combat. Refer to the *Power Armor Combat* section in the *Rifts RPG*, page 44.

Solar Combat Armor

In an attempt to find a technological equivalent to the Armor of the Sun, the armorers of Arequipa worked for years trying to develop a flame-covered suit of powered armor. In the end, they did not have the technological development necessary to produce this system, but their efforts intrigued the D-Bee engineers of New Babylon (see the **Silver River Republics**). A team of experts from the Babylonian Guilds worked on the project independently, and years later, produced a successful "flaming armor" suit. The prototype was sold to the Empire, and it proved to be a highly popular and effective model. By 100 P.A., the Solar Combat Armor was assembled in Arequipa, although many parts still need to be imported from New Babylon.

The principle behind the Solar Power Armor is highly innovative. The armor is covered by a number of magnetic field generators and plasma dischargers. When the flame system is activated, plasma is released at a constant rate by the dischargers. The plasma is then captured by the magnetic field generators and kept in a constant flux, about an inch away and around the armor. The magnetic field protects the armor surface from damage, projecting 90% of the heat outward, towards the enemy. The plasma field acts as a shield against flame attacks, and it also ignites or melts any materials that come into contact with it. The plasma makes the suit very effective in hand to hand combat. The main disadvantages of the flame system are that it

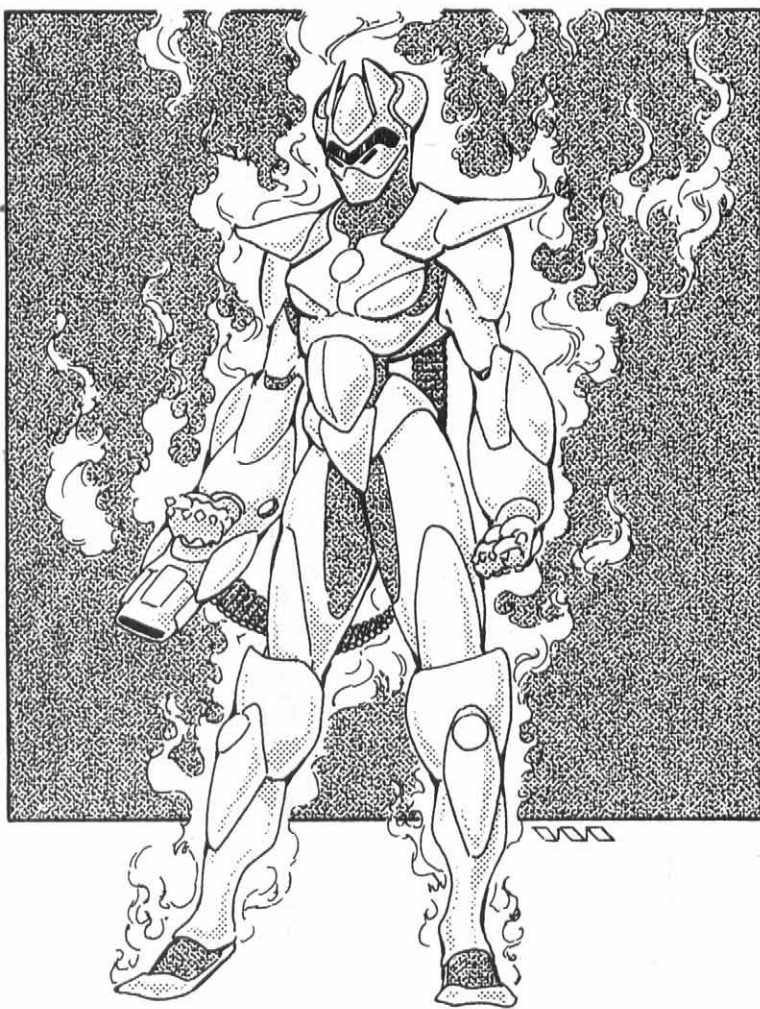

makes the suit detectable by any heat sensors or heat-seeking missiles, and the fiery plasma field can be seen by the naked eye for miles around. On the other hand, the plasma projectors can fire bolts of mega-damage flames from six different positions, enabling the pilot to engage targets in all directions. Also, the plasma field can be turned off instantly, which will invariably confuse heat-seeking missiles and sensor systems.

In addition to the plasma projectors, the suit has one integral rail gun built into its right arm and fed from a central magazine in the torso. The rail gun is highly effective against Arkhon Cerasteel armor and makes a good back-up for the plasma system. Finally, the Solar Combat Armor has a set of lasers installed in the eyes of the suit. Its flying propulsion system is much faster than the magical flight of the Armor of the Sun, making it a good answer for the fast attack fliers used by the Arkhons. The main drawback to the armor is its high cost, which limits the number the Empire of the Sun can put in the field.

Model Type: SC-Mark III

Class: Airborne Assault Exoskeleton with Plasma Field System

Crew: One

M.D.C. by Location:

Arms (2) — 120 each

Legs (2) — 200 each

* Head — 120

** Main Body — 320

* Destroying the head of the power armor will eliminate all forms of optical enhancements and sensory systems. The

pilot is forced to rely on his own human vision and senses. All power armor combat bonuses are lost. Hitting the head requires a called shot at -3 to strike.

** Depleting the M.D.C. of the main body will shut the armor down completely, making it useless.

Speed

Running: 60 mph (96 kmph)

Flying: 400 mph (640 kmph) maximum.

Range: Can fly for up to 24 hours without overheating. Maximum altitude is 20,000 feet (6096 m).

Statistical Data

Height: 7 feet (2.1 m)

Width: 4 feet (1.2 m)

Length: 3 feet (0.9 m)

Weight: 500 lbs. (226.5 kg).

Physical Strength: Equal to a P.S. 35

Cargo: None

Power System: Nuclear; average energy life is 15 years.

Market Cost: 20 million credits.

Weapon Systems

1. Plasma Projectors (6): These plasma projectors appear to be small knobs on the hands, chest, back and knees of the armor. The projectors can be used in two modes; first, to release the plasma used by the fire system (see below). The second, more common use is to fire plasma blasts at a distance. Although the six projectors do not add to the number of attacks the pilot has, the pilot can engage targets without having to aim a weapon at them; all he needs to do is activate the projector facing the target. As a result, when using this system the pilot gains a +1 to initiative.

Primary Purpose: Anti-armor

Secondary Purpose: Defense

Mega-Damage: 1D4×10+10 M.D. per blast. A simultaneous double hand blast does 2D4×10+20 M.D. (does not get an initiative bonus).

Rate of Fire: Equal to the combined number of hand to hand attacks of the pilot.

Effective Range: 2000 feet (610 m)

Payload: Effectively unlimited.

2. Arm Mounted Rail Gun: The rail gun barrel is mounted on the right arm of the suit, and it is fed rounds from a disintegrating belt that is coiled inside the arm and torso. Reloading the gun is a cumbersome process if not done at a military base where they have the right tools for the job, and requires taking off the suit.

Primary Purpose: Assault

Secondary Purpose: Defense

Mega-Damage: A burst is 80 rounds and does 1D6×10 M.D. Can only fire bursts.

Rate of Fire: Equal to the number of hand to hand attacks of the pilot.

Effective Range: 4000 feet (1220 m)

Payload: 2000 rounds, that's 25 bursts. Reloading takes 5 minutes in a military hangar.

3. Eye Lasers: These are a final backup weapons system for the armor suit.

Primary Purpose: Anti-personnel

Secondary Purpose: Defense

Mega-Damage: 2D6 M.D. per eye, or 4D6 M.D. per simultaneous double blast.

Rate of Fire: Equal to the number or hand to hand attacks of the pilot.

Effective Range: 1000 feet (305 m)

Payload: Effectively unlimited.

4. Plasma Field System/Flame System: This is a constant stream of plasma, held in place around the suit by a magnetic field. The field inflicts 3D6 M.D. to anything it touches. In hand to hand combat, it adds 3D6+6 M.D. to the hand to hand damage normally inflicted by punches and kicks. Additionally, any flammable materials within 10 feet (3.0 m) of the armor will ignite!

5. Hand to Hand Combat: Rather than use a weapon, the pilot can engage in mega-damage hand to hand combat. Use the bonuses listed under the Robot and Power Armor Combat skills, with the following modifiers to damage:

Punch: 1D6 M.D. (4D6+6 M.D. when the plasma field is on).

Power Punch: 3D4 M.D. (5D6+6 M.D./counts as two attacks when the plasma field is on).

Kick: 2D6 M.D. (5D6+6 M.D. when the plasma field is on).

Body Block Ram: Same as kick.

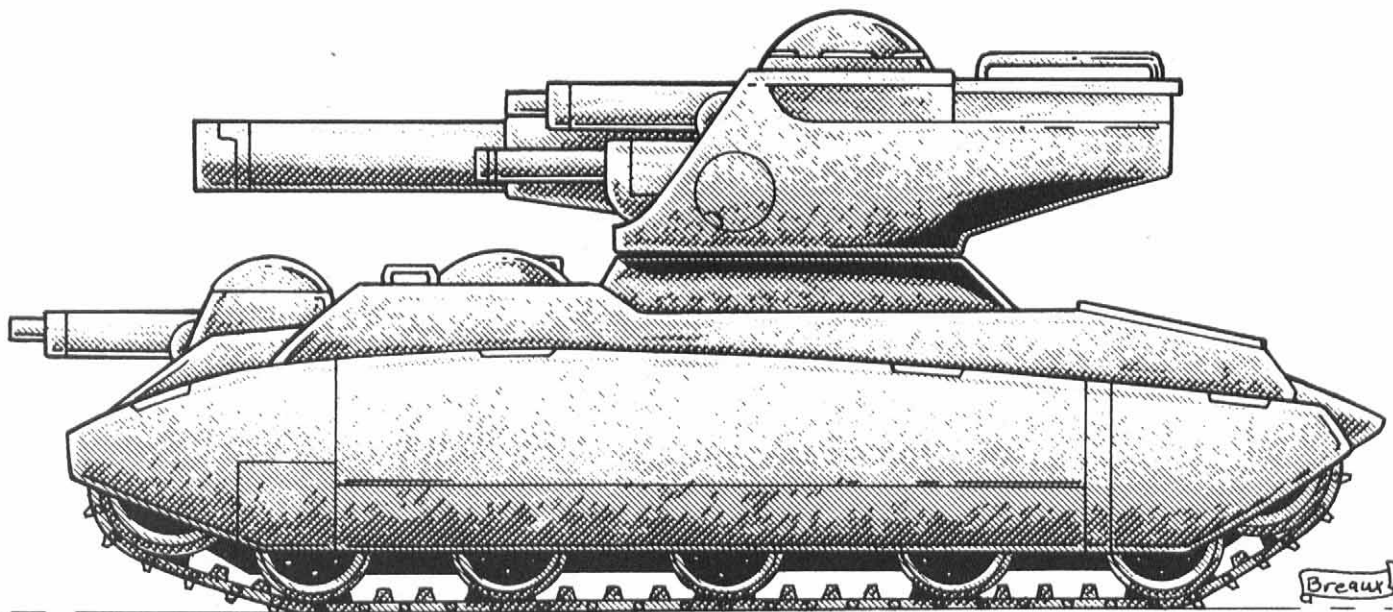

Slinger Light Tank

The Slinger H-1 is the only armored vehicle built in the Empire of the Sun. Slingers are manufactured in Arequipa, and are light tracked vehicles designed to be operated by two people, a driver and a gunner/commander. The tank is tiny, barely taller than a normal human. The commander sits half inside the main body, and half inside the turret; his seat rotates with the turret, and he has control over all of its weapon systems. The turret is armed with either a conventional 90mm cannon (the H1-C) or with a laser cannon (the H1-L). It also has a coaxial 15mm machinegun and an automatic grenade launcher. The pilot has access to a bow-mounted machinegun of the same make.

The tank does not use a nuclear power plant (very hard to manufacture in the Empire of the Sun). Instead, it is powered by diesel or electric engines. Although the tank is not extremely powerful or well-armored, it has done relatively well against the more advanced Arkhon war machines. Entire armored divisions depend almost exclusively on this vehicle for its armor and firepower.

Model Type: H1-C or H1-L

Class: Light Battle Tank.

Crew: Two; a pilot and a commander/gunner.

M.D.C. by Location:

Turret/Main Gun — 120

Bow-Mounted Machinegun — 40

* Track Treads (2) — 60 each

** Main Body — 220

* Depleting the M.D.C. of a tread will immobilize the tank until it is replaced. Replacing a tread will take 1D4×10 minutes by a trained crew (2 replacements are carried on board) or three times as long by the inexperienced.

** Depleting the M.D.C. from the main body will shut the tank down completely, rendering it useless.

Speed

Driving on the ground: 60 mph (96 kmph) maximum. Cruising speed is typically 40 mph (64 kmph).

Flying: Not possible.

Range: 400 miles (640 km) with electric or combustion engine.

Statistical Data

Height: 7 feet (2.1 m)

Width: 6 feet (1.8 m)

Length: 9 feet (2.7 m)

Weight: 5 tons

Cargo: Small storage compartment for two energy riles, and two 1 foot squared (0.3×0.3 m) areas for personal effects.

Power System: Gasoline or Electric.

Market Cost: 90,000 credits with all weapon systems.

Weapon Systems

1. Laser Cannon (H1-L Model): About 40% of all tanks are armed with this laser cannon. Although the laser has a greater payload than a conventional cannon, it is less effective against Arkhon armor.

Primary Purpose: Anti-armor

Mega-Damage: 1D6×10+10 M.D. per blast.

Rate of Fire: Each blast counts as one attack per melee.

Effective Range: 4000 feet (1220 m)

Payload: 500 shots per power battery (basically a giant E-clip that weighs 100 lb./45 kg).

2. 90mm Cannon (H1-C Model): The other 60% of the tanks use a conventional cannon instead of the laser. The cannon can use a variety of ammunition and is more effective against alien vehicles and robots.

Primary Purpose: Assault

Secondary Purpose: Defense

Mega-Damage: High-Explosive: 1D4×10 M.D. to a 20 foot (6.1 m) area. Armor-Piercing Sabot-Discarding Solid: 2D4×10+10 M.D. (no blast radius).

Rate of Fire: Up to four shots per melee. Each shot counts as one melee attack.

Effective Range: 4000 feet (1220 m)

Payload: 40 rounds total in two autoloading magazines. Usually, one magazine has high-explosive and the other has armor-piercing rounds.

3. Coaxial Machinegun and Grenade Launcher: These two weapon systems are aimed the same way as the main gun, although only one weapon at a time can be fired.

Primary Purpose: Anti-personnel

Secondary Purpose: Defense

Mega-Damage: Machinegun: 2D4×10 M.D. per burst of 10 rounds. Grenade Launcher: 3D6 M.D. to a 10 foot (3.0 m) area. It can also fire smoke, tear gas and other grenades.

Rate of Fire: Bursts and single shots only.

Effective Range: 2000 feet (610 m) for both.

Payload: Machinegun: 600 rounds (60 bursts). Grenade Launcher: 60 shot magazine.

4. Bow-Mounted Machinegun: This gun can be used by the pilot to engage targets in front of the tank.

Primary Purpose: Anti-personnel

Secondary Purpose: Defense

Mega-Damage: 2D4×10 M.D. per burst of 10 rounds.

Rate of Fire: Bursts only (each counts as one melee attack).

Effective Range: 2000 feet (610 m).

Payload: 600 rounds (60 bursts).

The Arkhons

Over two thousand years ago, an alien armada tried to invade the Earth. Thanks to the efforts of the Nazca civilization (see the **Empire of the Sun**, elsewhere), that invasion was repulsed. Now, the aliens are back. Fortunately, they have been taken by surprise once again, this time by the conditions on Rifts Earth. What had been a mighty fleet of powerful ships has now been divided and severely damaged, a shadow of its former self. Even so, the Arkhons still remain a powerful force which may affect the balance of power on Rifts Earth.

The Invaders

The Arkhons civilization developed technologically at roughly the same time as the Atlantean civilization (see *Rifts Atlantis*), thousands of years ago. These imperialistic aliens expanded their influence over hundreds of worlds, creating the mighty Arkhon Commonwealth. Although not utterly evil, the Arkhons' expansion was ruthless. Races who resisted were attacked without mercy and in a few cases, nearly exterminated in genocidal wars.

When probes found Earth, over two thousand years ago, the Arkhons saw a lightly populated planet, ripe for the taking. A small expedition was organized, enough to subdue the insignificant and primitive cultures then establishing themselves after the fall of Atlantis. The Arkhons had little experience with magic, and the Nazcans' counterattack took them by surprise, and obliterated most of their fleet. The **Arkhon Council** decided that Earth must be studied carefully before a new attempt was made. For the next two thousand years, the Arkhons turned their aims towards other worlds, and contented themselves with sending unmanned probes to examine the planet (some of which were the cause of more than a few UFO sightings).

The second, current invasion force to arrive on Earth was not an "official" Arkhon project. This time, the fleet was made up of a prominent Arkhon clan, the **Tlo-Arkhon**, who had lost their standing and their lands. The clan, totaling nearly a million, including servants, bodyguards, associate families (many of which belonged to other species), packed their belongings in their private fleet (which included a number of powerful warships) and set off towards Earth. Probes had been unable to sense what was happening on Earth for some time (since the Coming of the Rifts as a matter of fact), but the clan leaders dismissed this mystery and went ahead nonetheless; they had little to lose. The Tlo-Arkhon were confident of victory and thought they were prepared for the magical defenses of Earth, believing the Nazca plateau was Earth's main defense.

The Arkhons' second invasion armada arrived on Earth in the year 74 P.A. When the space-fold system of the Arkhons deposited the fleet near Earth orbit, disaster struck once again. The dimensional energies around Earth played havoc with the space-folding systems of the alien ships. Some Arkhon parapsychicists believe that Earth is trapped in a dimensional pocket that reacted badly with their space-warp engines. Others theorize that a Rift was created by the arrival of the ships, unleashing enormous energies. The end result was that one-third of the arriving fleet never materialized. Whether they are lost in limbo, have been warped to a different star system, sent to a different dimension, or atomized, is anybody's guess. To make matters worse, the Arkhons were instantly attacked by the pre-Rifts orbiting space defense network, as well as the orbiting space stations and defenders of moon base. Another quarter of their ships were destroyed and the fleet scattered into several factions as they fled into Earth's atmosphere. Several of these factions disappeared without a trace for several years.

The majority of the fleet's survivors plunged into Earth's atmosphere with no choice but to make a massive emergency landing. As fate would have it, they ended up making planetfall only a few hundred miles away from their ancient nemesis, the Nazca lines. Before attempting a landing, the frantic and desperate Arkhons tried to bomb the Nazca lines, but the mystical defenses of the line makers managed to protect them from the brunt of the attack. After the failed strafing run, the largest ships crash-landed on plateaus in the Andes mountain chain, others made it to the surrounding jungles and plains. The scattered Arkhons suffered an additional 10% casualties from bad landings, attacks from magic wielding natives or supernatural beings, and other mishaps. It took months to get reorganized, during which time the Arkhons managed to seize control of a large area of the continent. Soon the aliens came into conflict with the *Empire of the Sun* to the west and with the Silver River Republics to the east. All contact was lost with an estimated 100,000 survivors who were splintered from the main force and presumed lost (they are scattered in other parts of the world, mainly China and Asia).

Arkhons in Orbit

Note: Most of this information will be especially useful to Game Masters and players who use the **Mutants in Orbit** supplement (a sourcebook for *After the Bomb*® and *Rifts*®). Game Masters who have been running campaigns in that setting should feel free to change, omit or disregard the storylines introduced by the arrival of the Arkhons to Earth.

Many of the ships that had disappeared upon warping into Earth's orbit were warped forward in time, appearing almost thirty years later in space. They appeared near the human colonies who had survived the Great Cataclysm and had built new lives in space (see **Mutants in Orbit**). Starships from Freedom Station and the Moon Colony, which were just about to fight each other, saw these new arrivals as a new, more important threat. The human commanders on both sides agreed to call off their dispute and deal with these aliens. Although the Arkhons' ships were far superior technologically, they were damaged and in a state of disarray. An epic space battle followed that destroyed the two largest ships in the Arkhon armada and dozens of smaller ones. The Arkhons managed to break free from the engagement, however, inflicting savage losses on the two human fleets. The aliens then discovered that every single space-fold drive and faster-than-light system in their ships had been completely burnt out by the dimensional anomaly. They couldn't flee the solar system, and were stuck in space.

Roughly 250,000 Arkhons have ended up stranded in our solar system. Bad as it may be for the Arkhons, it is worse for the struggling space communities that had lived in space since the Great Cataclysm. A new power has joined the floating colonies in Earth's orbit. The most immediate change was the furious space battle that erupted in space. The resulting conflict weakened every space power around Earth, with the exception of *Outcast Station*.

The commanding officer of this Arkhon fleet, Lord Tarris, is theoretically under the control of the leader of the ground forces,

but both he and Overlord Enno know that he is mostly on his own. Even communicating with Earth is virtually impossible, to the point that only a monthly conference can be scheduled to keep both sides abreast of what's going on. The communication problems may be the result of debris orbiting the planet or dimensional anomalies surrounding it. In any case, Lord Tarris is the real commander of the forces in orbit. Ironically, Tarris was actually an opponent of the plan to invade Earth, but now that they are stuck orbiting what he calls "this hellish mudball," he plans to make the most of it.

The goal of the Arkhons in orbit is to secure a planetary base. Although their ships have enough life support systems and supplies to keep the crews and colonists alive for several decades, they will not be enough for the long term. To survive, the Arkhons need to have access to the resources of a planet or at least the asteroid belt. Three separate undertakings aim to achieve this.

The first target of the Arkhons is the Moon Colony, better known as the *CAN Republic*. As the largest and most powerful colony, the CAN Republic is an enemy that must be subdued sooner or later. Constant raids by spacefighters ravage the colony's installations on a regular basis. Although such attacks are always defeated, often with higher casualties among the attackers, the Arkhons are slowly weakening the human colonists. At this point, it would be easy for the other space civilizations to attack and maybe even conquer the Moon, but most Earth colonies have decided that the Arkhon threat is more important than previous conflicts, and are not taking advantage of the moon colony's weakness.

The main part of the Arkhons' fleet has headed toward Mars. The planet has all the raw materials the Arkhons need to sustain themselves for centuries. Unfortunately for the aliens, settling on Mars for good will take centuries of terraforming, something they lack the equipment to do (their plan was to conquer a habitable world; the Arkhon culture prefers to conquer rather than terraform). The only obstacles the aliens have found on that planet are the insectoid mutants that plague it and the Rifted creatures and monsters that prowl the Martian wastelands. By 100 P.A., the Arkhons managed to establish a small base on Mars, and are slowly expanding their influence on the red planet.

The Arkhons in South America

The majority of the Arkhon Armada has established a Freehold in the mountain chains of pre-Rifts Ecuador that extends into the Andes mountains, some of the Amazon Jungle and the plains to the East. The Freehold consists mainly of isolated or semi-isolated settlements, usually built around their downed starships.

History

The Arkhons' developed on an Earth-like planet some two million years ago. Their civilization developed at roughly the same speed as on Earth, but with a couple of thousand years'

head start. The dominant culture was warrior and family-based. Each Great Family had thousands and, eventually millions, of members. Each family controlled a large area of land, as well as the region's army, industry and businesses. The Great Families competed, made and broke alliances, and only worked together to safeguard their common interests. Somehow, this disjointed culture managed to conquer and absorb all others, achieving complete dominance over their planet. A World Council, attended by representatives of all the Great Families, was founded shortly thereafter.

The discovery of space flight and the capability to travel to other planets, allowed the Great Families to once again strike out on their own. The largest and most powerful clans established space programs and started colonizing and conquering worlds inhabited by primitive people. When one of the families invaded another *advanced* civilization, the ensuing war forced them to ask for help from their Arkhon "cousins." The World Council, which for decades had been a mostly ceremonial institution, soon became a powerful force that would quickly turn into an interplanetary government, overseeing the Arkhons' Great Families and the races who had fallen under their sway.

Even under the new system, the Great Families continue to bicker amongst themselves. One of those disputes involved the Tlo-Arkhon family and the invasion of Earth. The family was one of the most influential, but the greed and savagery of its leaders eventually proved too much for even the Arkhons to stomach. When *Overlord Enno Tlo-Arkhon*, the clan leader, ordered the massacre of one million rebellious aliens on a recently conquered world, the World Council turned against the entire family. Without support from the other clans, and outnumbered and outgunned by the Council, Overlord Enno had no choice but to surrender and accept the rulings of the council. The clan was stripped of all its holdings, but was allowed to keep its weapons and starships. The ships' computers were programmed to set course for Earth, the mysterious planet that once before had thwarted their conquest efforts. Clan Tlo-Arkhon believes that they could prove themselves worthy by conquering that planet; nobody would help them, and if they failed there would be nowhere to go. Thus, they leapt into the breach.

Culture

The Arkhons are a family/clan-oriented warrior society that has thrived for thousands of years. The dominant culture originated in inhospitable plains, and was made up war-like of nomadic tribes who conquered and absorbed their wealthier neighbors. As a result, Arkhons greatly respect prowess in combat and military skills. However, they are not simple-minded barbarians who will charge headlong into battle at the slightest provocation; instead, they plan and act with cold-blooded precision, plotting and calculating the best tactics and doing what is best for themselves and their families. Unlike other warrior races, the Arkhons do not have an overpowering sense of honor, either. They will cheerfully ambush, betray or break treaties with their opponents and rivals if it best serves their purposes. They do this even when fighting amongst themselves, let alone other races and cultures. Consequently, as many battles are won through treachery and duplicity as they are with brute force.

The Arkhons on Earth came from a family of rogues regarded as miscreants even among their race. The Tlo-Arkhon made

many enemies with their dreams of glory, bids for power, crimes and cruelty. Now the survivors on Earth are truly desperate beings, willing to pay any price to regain their wealth and power. Overlord Enno, ruler of the family, is a brutal, cruel and calculating being. He had planned to conquer Earth and use its people and resources to build a huge fleet with which he would return home and destroy his "cousins" if they did not give him the respect and position he and the Great Family deserved. Instead, he now is reduced to the role of minor warlord in a savage and turbulent land. This infuriates him and many other Tlo-Arkhons. Still, he has a formidable army and feels that eventually he might fulfill his dreams. His first goal is the conquest of the continent and then of the world. At this point, he knows little of what lies outside South America, so he is bound to be bitterly disappointed when he sees the formidable forces arrayed against him. In time, however, he may become a force to be reckoned with. Even if he and his forces are doomed to oblivion by Enno's shortsightedness, they will cause great conflict and destroy thousands before they perish.

The government of the Arkhon family units or clans are family-based. The Overlord's title is *Wellekhon*, which means both "overlord" and "patriarch." The Wellekhon is, in effect, the parent-figure of the entire clan, and everyone else is his "child," honor-bound to be obedient and respectful. He is assisted by the Elders, the older and wiser members of the clan, who advise him in all matters. However, all final decisions remain with the Overlord. On a few occasions, insane or self-destructive Overlords have been assassinated by the Elders, so their advice is always respected and often heeded (and their activities secretly monitored).

The Arkhon Freehold

Population Breakdown: 600,000 total (50% Arkhons, 30% Fal-lam, 15% human servants, 5% other races). An additional 400,000 humans and D-Bees live in the area, usually in small villages (under 200 inhabitants per each community). These villages are usually ignored by the Arkhons unless they try to fight them or resist their will.

After their ill-fated arrival on Earth, the Arkhons settled in about a dozen citadels, built around the remains of their powerful starships. Given the firepower of these starships (including energy cannons that inflict damage in excess of 1D4×1000 M.D.!), these citadels are basically impregnable against anything but the largest armies, or small commando raids. Fortunately, all those ships are grounded for good, and their mountainside location make their firepower relatively short-ranged. The main guns could conceivably shoot through the mountains, but this might lead to a massive avalanche that would bury the ships and everybody in them. The Tlo-Arkhon and Overlord Enno are vindictive, driven and not frustrated, but they are completely insane or suicidal.

Each citadel has between 5,000 and 50,000 people, except the Great House, built around the flagship of the fleet, which houses 150,000 people (mainly Arkhons). The citadels are organized and spread apart no further than 100 miles (160 km) from each other, allowing for reinforcements to arrive relatively quickly.

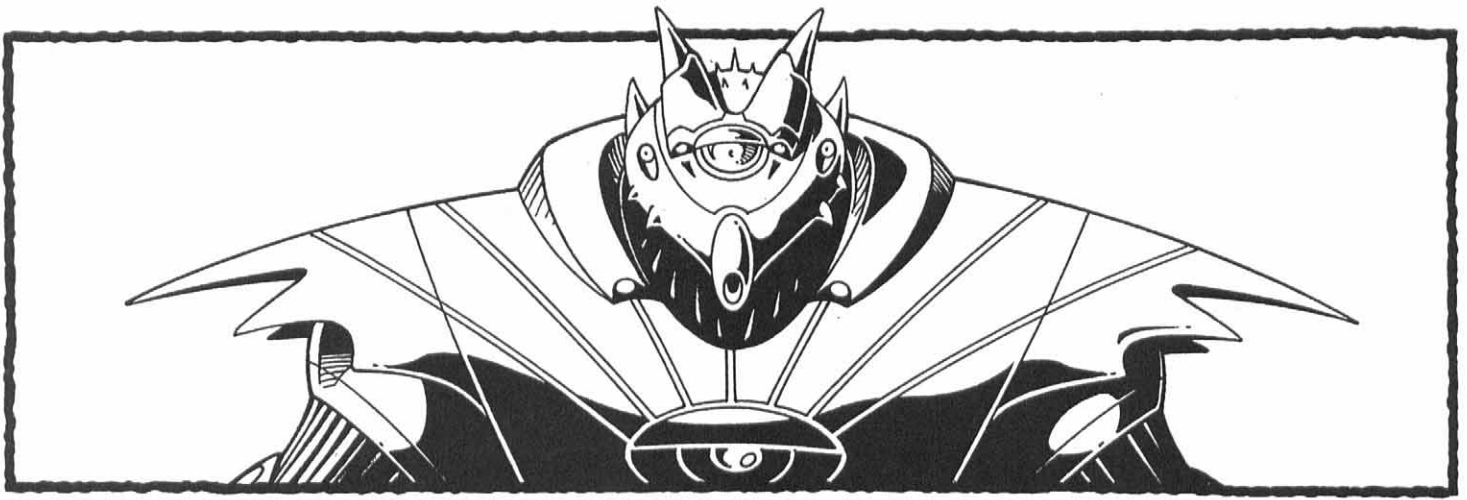

Constant aerial patrols monitor the major mountain passes. These patrols are often attacked by either the Incas, the Megaversal Troopers, or soldiers from the Silver River Republics, so casualties are high. Land patrols, combining heavy robots, armored vehicles and power armor, are sent on reconnaissance and raiding missions. Border villages and towns in other nations are often targeted first. Typically, the target is looted and anybody who doesn't flee immediately is killed. The Arkhons rarely take slaves, and they already have all the human *servants* they need. Even more feared, however, are the **Arkhon Spectral Hunters**, a special brand of cyborg with terrifying stealth and weapon systems. The Hunters often undertake "terror missions," committing all kinds of atrocities to "teach" humans the consequences of rebellion.

Arkhon Armed Forces

The Arkhons Armed Forces are divided into two branches: the Land Army (LA) and the SAS (Space-Air-Sea) Army. The Land Army is itself divided into Mechanized Infantry, Armored Cavalry and Air Cavalry. **Mechanized Infantry** are the ground soldiers, carried in transports or using light exoskeletons like the *Stormwind Units*. **The Armored Cavalry** includes tanks, artillery, ground robots and power armor. **The Air Cavalry** consists of flying power armor suits and light attack aircraft.

The SAS Army controls the skies, the seas, and empty space. It flies the lethal fighter-bombers that spread terror in Inca cities, and it deploys small submersible ships to interdict oceangoing trade. Its role has become limited, and many of its own combat troops (marines) are now assigned to larger Land Army units.

In all branches of the Army, the smallest unit is the **Fireteam** (equivalent to a squad): Arkhon fireteams have 10-12 infantrymen, 3-5 power armor soldiers, or 1-3 aircraft, tanks or robots. Fireteams are commanded by a *Swordbearer*.

Following the Fireteam is the **Triangle**, the Arkhons' version of a company. A Triangle consists of three fireteams, about 30-40 infantrymen, 10-20 power armor troopers, and 3-12 aircraft, tanks, robots or heavy vehicles. Triangles are led by a *Knight* and an assistant *Swordbearer* (for a total of four *Swordbearers* in the Triangle).

A **Shield** consists of four Triangles and support units, including a medical team, an artillery battery, and a supply and repair team. Shields have between 120-200 soldiers, plus an additional 40-60 support personnel. Typically, a Shield has two Triangles of infantry, one Triangle of power armor troopers, and a triangle

of tanks or aircraft, although all-infantry or all-tank Shields are used in large-scale conflicts. Shields are the largest unit used in most operations since the Arkhons' landing. Shields are commanded by a *Duke* and his staff (usually two staff Knights and four *Swordbearers*).

Larger and less-used units include the **Shieldwall** (4 Shields, 400 to 800 soldiers), the **Phalanx** (4-6 Shieldwalls, 2,000 to 5,000 soldiers), and the **Army** (2-4 Phalanxes, 6,000 to 20,000 soldiers). The Arkhons have only moved Armies on two occasions; one large-scale assault in 85 P.A. against the Inca Empire (see the **Battle of Huari** in the **Empire of the Sun** section), and a later move in 93 P.A. against a threatened attack from Cordoba; when the Cordobans saw a 20,000 strong alien Army maneuvering near the plains, they quickly reconsidered and called off their invasion.

Overlord Enno

The ancient patriarch of the Tlo-Arkhon family, Enno has, for good or ill, led his people for over a hundred years. Under him and his father's tutelage, the Tlo-Arkhons became the largest and most powerful family in Arkhon space, controlling over two dozen inhabited worlds and many times as many mining colonies, space stations and other installations. Enno's ambition and ruthlessness became infamous even before he inherited the title of Overlord. As his father's second in command, he personally led the Tlo-Arkhon armies against entire planets, showing his mastery as a strategist and suppressing all resistance without mercy. When his father was assassinated by a rival family, Enno swiftly consolidated his hold on the clan and then proceeded to destroy his father's killers, managing to make a number of gains for his family in the process. Many prominent Arkhons believed that if anybody could unify the *entire* Arkhon Dominion under one rule, it would be this brilliant and merciless overlord.

It was then a combination of fear, hatred and revulsion that motivated the other Arkhon families to turn against Enno and his family. The crimes with which he and his people were accused (the genocide of over a million sentients) were real, but the real crime for which the family suffered was that Enno's Great Family was threatening the status quo and needed to be suppressed. At least, that is how Enno clearly sees events. He has sworn that one day, he or his heirs will return and take revenge on his tormentors.

Even in defeat, Overlord Enno had a grand vision. His choice as a place of exile was the mysterious world where the Arkhons

had suffered their greatest defeat. The Overlord decided that he would conquer Earth, and then use its resources to return in triumph and reclaim his rightful place among the World Council. Most of his clan elders believe in Enno's vision, and will follow him anywhere.

Overlord Enno is a tyrant, used to being feared and respected. Underlings are expected to grovel and kneel before him, and he expects such behavior from everybody, with the exception of the Elders and other powerful beings. Prisoners who do not show the proper respect are tortured or killed without a second chance. He will usually treat other members of his family well and with honor. Everyone else is beneath his contempt and he will not hesitate to lie, cheat or harm outsiders. A cold-blooded murderer, Enno had over a million people (including children, old people and other non-combatants) executed when a conquered planet's rebel forces wouldn't surrender, and that is just one of many atrocities. He is willing to go to any length to further the interests of his Great Family. His plans for the Empire of the Sun include mass executions of all Inca nobles and demigods; he has a list of specific targets to be assassinated or captured, and it runs into the hundreds of thousands!

Foreign Relations

The Arkhon Freehold's main goal is to expand and eventually take over the entire planet. The aliens still do not know enough about Rifts Earth to realize how hopeless their task is.

The Empire of the Sun: The Incas and their gods are the Arkhons' most hated and deadly enemy. As the heirs of the secrets of the Nazca lines, the Incas hold the power that once swatted an entire invasion fleet out of the sky, and the Arkhons haven't forgotten that. A state of war exists between the Arkhon Freehold and the Empire. Skirmishes and even full-scale battles occur often. So far, the Incas' magic, technology and superior numbers have held the aliens at bay. As the Arkhons grow in numbers, gather recruits, and start producing more and bigger weapons, the tide may turn.

Most of the war is being fought in the mountain ranges. Arkhon aircraft fly through narrow mountain passes, shooting anything they see, often killing innocent villagers and travelers. Inca mages and snipers attack those ships whenever they see them. Also, armed units ranging in size from squads (6-10 men) to full-fledged battalions (500-1000 troops) are sent on search and destroy missions (by both factions), or try to capture towns, villages and major road junctions. So far, there isn't a clear "war front," but as both sides commit more and more troops to the war effort, the battle lines will soon become clearly drawn. At this point, the war is one of raids and counter-raids and of civilians living in fear that one side or the other will come and plunder or pillage.

The Megaversal Legion: This band of transdimensional mercenaries has its headquarters in the Andean mountain range, which is also occupied by the Arkhons. Soon after their arrival, a scouting force of Arkhons made contact with the ML troopers. The overconfident aliens attacked without warning, only to be overwhelmed and killed to the last man. Since that encounter, the Legion destroys any Arkhons who enter its territory. At this point, the aliens are too busy with their war against the Incas to do anything major against the mercenaries; a number of raids and assaults and one full-fledged battle have erupted over the

last few years. In almost every such encounter, the Legion carried the day.

The Silver River Republics: *The Republic of Cordoba* (see the *SRR* section) has borders with the Arkhon Freehold. Overlord Enno realizes that eventually, the Arkhons will have to expand east into the fertile plains occupied by these republics, but his vendetta against the Empire of the Sun is taking precedence over all other projects. For the time being, the Arkhons are content with sending small-scale forces into Cordoba to engage in supply raids, seek and destroy missions, reconnaissance and to test the mettle of this potential enemy.

If a good opportunity for expansion arises (for example, if Cordoba becomes involved in a war against its neighbors), the Arkhons might decide to take advantage of the situation and launch a full-scale invasion. The aliens see the mutant-populated *Achilles Republic* as a possible ally in a war against Cordoba; the two nations are mortal enemies. Consequently, they have not taken any military action against the Achilles Republic and are considering making diplomatic contact with them.

The Arkhons also know about another group of extraterrestrials living in the area; the *Amaki*, transdimensional colonists who, together with humans, have formed the prosperous nation of *New Babylon*. The Arkhons are very concerned about the Amaki, whom they see as possible competitors.

The Republic of Colombia and the Vampire Kingdom of Haktla: These two nations in the north are locked in a savage war to the death. The Arkhons are aware of the conflict, and fear that the vampire kingdom might start expanding south into their territory, but for the most part, the aliens do not involve themselves with either side. Explorers from Colombia are killed on sight, as are vampires. Colombia and Haktla are described in *Rifts South America: One*.

Atlantis: Strangely enough, the Arkhons have never had any contact with the Splugorth; they live in a region of space that is yet to be tainted by those alien intelligences and their minions. In the last couple of years, long-range scout patrols have traveled all the way north into the Devil's Triangle. Only a few have returned alive, with terrifying stories of monster-filled cities and alien technologies fully the match of the Arkhons! Overlord Enno now considers Atlantis to be the Arkhons' major rival, although he refuses to admit, even to himself, that he and his army are completely outmatched by those transdimensional beings. Meanwhile, Lord Splynncryth is aware of the alien presence in South America, but he considers it to be insignificant and hardly worth his attention.

Arkhon R.C.C.

The Arkhons are alien humanoids with a mix of feline and reptilian characteristics. Their bodies are slender and agile. Athletic Arkhons are wiry rather than over-muscled, although their overall strength tends to be higher than the human average. They have a slightly crouched posture, their smooth skins are yellow-grey, and they have no body hair or scales. Their eyes are almost identical to those of humans, and their ears are large and pointed. They favor skin-tight clothing, capes, and decorative chain mail or plate armor. Soldiers wear stylized body armor

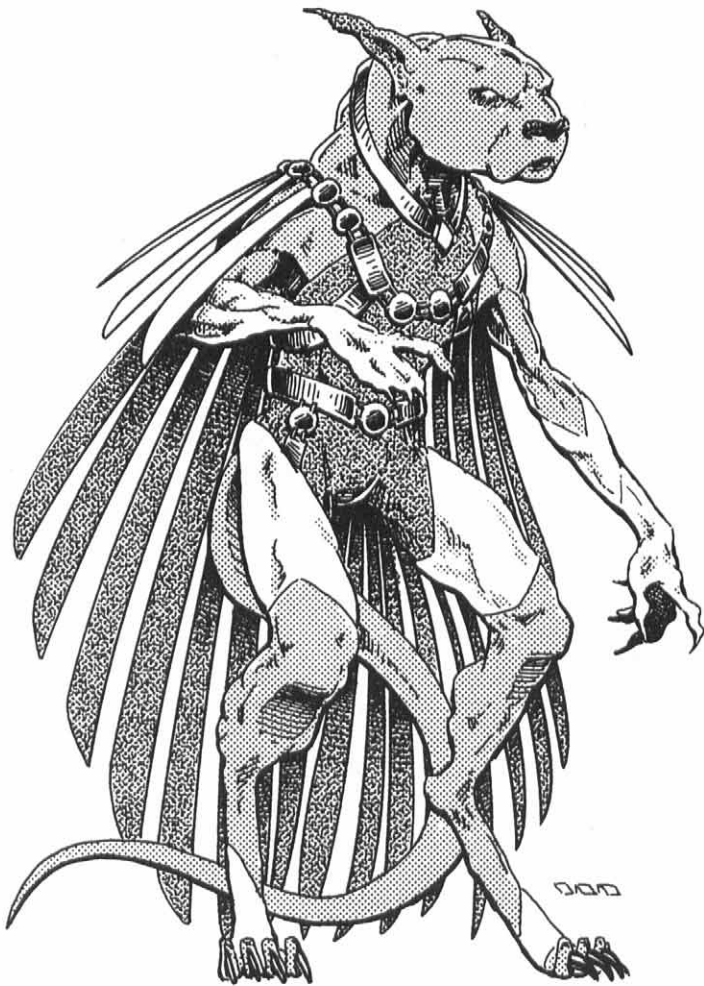

with one central “eye” and decorated with short spikes. The military uses red for both uniforms and vehicles/power armor. Civilian garb runs the whole gamut, and some Arkhons have adopted Earth clothing as a fashionable new trend.

This species developed in an Earth-like world, so they are perfectly adapted to survive in Earth’s environment. They favor high elevations, and are better adapted to the thin air of the mountains, but can do equally well in the jungles or even desert climates. They dislike extremes of heat or cold, and have roughly the same tolerances as humans. The one exception to this is humidity; a level of humidity that would be uncomfortable to humans (60% or higher), will make the aliens weak and easily exhausted (-4 to initiative, -2 to all combat actions, and lose one attack per melee). For this reason, they avoid jungles like the plague, unless they are wearing environmental armor. The only Arkhons who regularly venture into the humid jungles are the bionically-enhanced **Spectral Hunters**.

The Arkhons’ warrior culture values skill and success above all other things. Success is the most important quality. Winning is very important, regardless of how it is accomplished, and the whole concept of an “honorable defeat” is alien to their mindset. If a warrior fails at a task, then he obviously wasn’t good enough. Luck is considered to be a trait; an unlucky person is avoided, and his bad fortunes considered to be his own fault. This cultural bias has deeply affected the Tlo-Arkhon family. The entire clan was defeated and forced into exile, so they considered themselves to be failures, and are desperate to redeem their reputation. The disasters that have ravaged the clan upon

arrival are regarded as bad luck and have worsened their desperation and sense of doom. Overlord Enno in particular is concerned with wiping out the stigma of being a luckless war leader.

The second element of the Arkhons’ culture is obedience. One’s superiors are considered to be more successful, and therefore, worthy of being heeded and followed. Even if a leader fails, it is not his underlings’ place to criticize him; instead, the leader’s equals will overthrow and replace him. Should Overlord Enno continue to fail, he will eventually be replaced by one of the Elders. Meanwhile, however, all the warriors are duty-sworn to follow his orders and most still regard him as a supreme leader.

These two elements result in a peculiar code of ethics. Arkhons have a twisted code of honor, but it does not prevent them from lying and betraying their enemies. Their code simply states that winning is the most important thing, and that winners can rewrite history to erase all past sins. This culture tends to produce miscreant, anarchist or aberrant characters. Most Arkhons of good alignment find themselves rejected by their peers. Some of these outcasts have deserted the Arkhon army and escaped. A few have founded small settlements in the far South, where they have to fight or hide from the **Larhold Barbarians** (described elsewhere).

Alignment: Any. A majority (65%) of the Arkhon invaders are anarchist or evil (typically miscreant or aberrant), but the remaining 35% runs the whole gamut.

Attributes: I.Q. 2D6+6, M.E. 3D6, M.A. 3D6, P.S. 2D6+12, P.P. 2D6+12, P.E. 3D6+4, P.B. 3D6+6, Spd. 3D6+10

Size: 5-7 feet (1.5 to 2.1 m).

Weight: 120 to 200 lbs. (54 to 90 kg)

S.D.C./Hit Points: 2D6x10 S.D.C. in addition to skill bonuses.

Standard hit points, same as humans.

M.D.C.: By armor only.

Horror Factor: None

Average Life Span: 200 years with access to advanced medical technology; half that otherwise. Some wealthy and powerful Arkhons have managed to extend their lives by as much as 500 years, using expensive chemical treatments, cloning internal organs, and advanced anti-aging techniques.

Natural Abilities: None. Their senses are roughly equivalent to humans.

Experience Level: Varies.

Combat: By skill.

Damage: Bite does 2D6 S.D.C., and claws add 1D6 S.D.C. to hand to hand punches and kicks.

Bonuses: +1 on initiative, +2 to roll with impact, +2 to pull punch, +2 to save vs magic and +3 to save vs horror factor.

These are in addition to skill and attribute bonuses.

Magic Powers: None. While some Arkhons might learn magic, their culture abandoned its use millennia ago and they still do not believe in it — and belief is the basic element in working magic. Their disbelief actually helps them better resist magic spells (see bonuses).

P.P.E.: Standard; same as humans.

Psionic Powers: A higher incidence of psionic powers exists in this race. 01-18%: Major Psionics; 19-50%: Minor Psionics; 51-56% master psionics. A tiny percentage are master psionics. These become *Arkhon ESP Specialists*.

Vulnerabilities/Penalties: None.

R.C.C. Skills:

Language and Literacy: Arkhon (98%)
Language: Two of choice (+15%)
Computer Operations (+15%)
Basic Radio (+15%)
Running
Pilot: One of Choice (+10%)
W.P. Energy Rifle
W.P. Energy Pistol
W.P. Sword or W.P. Knife (choose one)
Hand to Hand: Expert
Hand to Hand: Expert can be changed to Hand to Hand: Martial Arts at the cost of one "other" skill.

R.C.C. Related Skills: Select 8 other skills. Plus select one skill at levels three, five, eight, eleven, and fourteen. All new skills start at level one proficiency.

Communications: Any (+10%)
Domestic: Any
Electrical: Any (+5%)
Espionage: Any (+5%)
Mechanical: Any (+5%)
Medical: Any (+5% on paramedic)
Military: Any (+10%)
Physical: Any
Pilot: Any (+5%)
Pilot Related: Any (+5%)
Rogue: Any
Science: Any (+5%)
Technical: Any (+10%)
W.P.: Any
Wilderness: Any

Secondary Skills: The character also gets to select five secondary skills. These are additional areas of knowledge that do not get the advantage of the bonus listed in parentheses. All secondary skills start at the base skill level. Also, skills are limited (any, only, none) as previously indicated in the list.

Alliances and Allies: The Tlo-Arkxon Clan brought along warriors from the Fallam race, an alien species that the Arkhons conquered centuries ago. Most of the Fallam are loyal to the Freehold. Additionally, a few human and D-Bee servants have been assigned to minor guard duty and other "trustworthy" positions.

Weapons and Equipment: Arkhon energy rifle and pistol of choice, a suit of combat armor, communicator, survival kit, survival knife, and an archaic or modern weapon of choice. Power armor and special weapons and vehicles may be assigned for special missions.

Money: 1D6x1000 Arkhon credits (useful only within the Freehold). Renegades who have lived outside the Freehold can have 2D6x100 standard credits.

Arkhon

Spectral Hunter O.C.C.

The Tlo-Arkxon Clan was well-known among its culture for its interest in cybernetics, bionics and artificial augmentation. Instead of metals, the materials of choice for the Tlo-Arkxon cyber-docs were advanced polymer plastics and ceramics. The resulting product, best known as *Cerasteel*, has a pseudo-organic feel and is highly resistant to energy damage (this same material is used in weapons and armor; see the **Arkhon Weapons and Equipment**). The Spectral Hunters are living military applications of their advanced cyber-technology. These soldiers are all volunteers who undergo full bionic conversion. Rather than metal 'borgs, however, the Hunters look like spike-covered hard-shelled humanoids. Some people confuse their organic look for biomancer armor (see *South America Book: One* for more details on biomancy), something that has helped the Arkhons on more than one occasion. The armor uses an advanced chameleon system to allow the 'borgs to move unnoticed and ambush unsuspecting enemies.

The Spectral Hunters operate in both the mountains and jungle areas. Their primary goal is to locate and "neutralize" enemy patrols and scouts. Additionally, they act as scouts themselves, using their stealth systems to slip unnoticed past enemy pockets. The 'borgs are also sent out on missions of "Morale Adjustment." These words are a euphemism for terrorism: Morale Adjustment undertakings often involve massacring civilians, kidnapping and executing enemy officers, and acts of murder and mutilation designed to terrorize the enemy. After a few Morale Adjustment missions, most warriors become extremely bloodthirsty and violent. Although they are trained to repress their savage urges, they like to indulge in slaughter at any opportunity. Many a small village has been used for "entertainment," its entire population massacred by a small squad of 2-6 Hunters. The cyborgs prefer to fight "worthy" opponents, however, such as True Incas, Rune Warriors and the Megaversal Legion's Destroyer 'Borgs. Brutal duels between these superhuman opponents often lay waste to whole sections of jungle or mountains.

O.C.C. Abilities and Bonuses:

1. Cerasteel Bionic Reconstruction: Most of the Hunter's body has been replaced with advanced ceramics and polymers that grant him superhuman endurance and strength. Cerasteel is stronger and more durable than comparable Earth alloys, and is a better heat dissipater, which gives it an edge against energy weapons. As a result, the Spectral Hunter's body becomes an M.D.C. structure with 320 M.D.C. Arms and legs have 50 M.D.C. each, and hands and feet have 15 M.D.C. Additionally, the spike-covered armor adds an additional 380 M.D.C. All these alloys take half damage from energy/heat weapons (including lasers, particle beams, plasma projectors, and flame-throwers), but suffer double damage from impact weapons (bullets, punches, etc., but not including explosions, which only do normal damage). Magical attacks inflict full damage (no modifiers).

2. Bionic Attributes: The Cerasteel construction gives the Spectral Hunter's body the equivalent of a Robotic P.S. of 40.

Advanced reflex packages give the character P.P. 25 and a running speed of 120 mph (192 kmph)!

3. Chameleon System: Spectral Hunters can change the color of their shell armor to match the surroundings. This gives people trying to spot the cyborg a -20% to detect ambush and detect concealment, and +5% to prowl skill. The armor masks infrared and thermal emissions, making the wearer's heat invisible to infrared and thermal optics. There is only a 21% chance of showing up on thermal systems and even then the reading/image will seem unusual.

4. Other Bionic Systems: In addition to these systems, the character has the following bionic and cybernetic systems. These are roughly equivalent to Rifts bionic systems, although the Arkhon versions are often lighter and more durable.

Bionic Lungs

Multi-Optic Eye

Sensor Hand (located in the tail instead, but same effects)

Built-in radio receiver and transmitter.

Built-in Speech Translator

Molecular Analyzer.

5. Bonuses: +1 on initiative, +2 to roll with impact, +5 to save vs horror factor. Plus attribute, bionic system and skill bonuses.

Arkhon Spectral Hunter O.C.C.

Alignment: Any, but 70% are evil and 25% anarchist.

Attribute Requirements: None; bionic systems replace most physical attributes.

O.C.C. Skills:

Language and Literacy: Arkhon (98%)

Language: Two of choice (+15%)

Computer Operations (+15%)

Basic Radio (+15%)

Tracking: Animals and humans (+15%)

Detect Ambush (+15%)

Prowl (+15%)

W.P. Energy Rifle

W.P. Energy Pistol

W.P. Sword

W.P.: One of choice

Hand to Hand: Expert

Hand to Hand: Expert can be changed to Hand to Hand: Martial Arts at the cost of one "other" skill.

O.C.C. Related Skills: Select six other skills. Plus select one skill at levels three, five, eight, eleven, and fourteen. All new skills start at level one proficiency.

Communications: Any (+10%)

Domestic: Any

Electrical: Any (+5%)

Espionage: Any (+10%)

Mechanical: Any (+5%)

Medical: Any (+5% on paramedic)

Military: Any (+5%)

Physical: Any

Pilot: Any

Pilot Related: Any (+5%)

Rogue: Any (+5%)

Science: Any (+5%)

Technical: Any (+10%)

W.P.: Any

Wilderness: Any (+10%)



Secondary Skills: The character also gets to select four secondary skills. These are additional areas of knowledge that do not get the advantage of the bonus listed in parentheses. All secondary skills start at the base skill level. Also, skills are limited (any, only, none) as previously indicated on the list.

Standard Equipment: Two energy weapons of choice (sometimes carries captured weapons and equipment as a badge of honor), one vibro-blade or archaic weapon of choice, and 4 E-clips or spare magazines per weapon.

Money: 2D4×1000 Arkhon credits.

Cybernetics: See above.

Arkhon ESP Specialist O.C.C.

While a lot of Arkhons are psionically talented, only a few are true master psionics: Most Arkhon families carefully train and cultivate these psychics to their full potential, and use them as elite scouts, warriors and spies.

The ESP Specialists are organized in special fireteams and attached to larger units. Their main mission is to provide counter-intelligence and anti-magic protection. Since the Arkhons are fighting a number of magically adept civilizations and supernatural creatures, the ESP Specialists have been trained to detect such powers. On more than one occasion, would-be assassins and spies with magical or supernatural abilities have been detected and stopped before they could carry out their missions. Even normal humans are in trouble, as the ESP Specialist's empathic and telepathic powers are very effective in ferreting out the truth. Additionally, these psychics have at least a few powerful abilities that allow them to personally take action against the enemies of the Arkhons.

Some specialists are attached to the Interrogation Squads, a feared unit within the Arkhon Army. Interrogators are experts in getting information from prisoners, and know all forms of torture and questioning. Psychic interrogators use their powers to succeed where torture might fail.

O.C.C. Abilities and Bonuses:

1. Sensitive Psionic Powers: At first level, all ESP Specialists have the following sensitive powers:

Empathy
Mind Block
Presence Sense
See Aura
See the Invisible
Sense Magic
Telepathy

At each additional level of experience, the character can choose one more sensitive power.

2. Other Powers: The character can also select either two powers from the physical or healing categories, OR he can pick one super-psionic power. Every level after the first, the character can select an additional power of any category, in addition to the one sensitive power.

3. Bonuses: Considered to be a master psionic. +1 on initiative, +1 to roll with impact, +3 to pull punch, +5 to save vs horror factor. These are in addition to skill and attribute bonuses.

4. I.S.P.: 2D6x10 plus M.E. attribute number, plus 10 I.S.P. per additional level of experience.

Arkhon ESP Specialist O.C.C.

Alignment: 45% are miscreant, 25% aberrant, 10% diabolic, 15% anarchist and 5% other.

Attribute Requirements: M.E. 14 or higher; master psionic.

O.C.C. Skills:

Language and Literacy: Arkhon (98%)
Language: One of choice (+15%)

Computer Operations (+15%)

Basic Radio (+15%)

Intelligence (+10%)

Interrogation (+10%)

W.P. Energy Rifle

W.P. Energy Pistol

W.P. Knife

Hand to Hand: Basic

Hand to Hand: Basic can be changed to Hand to Hand: Expert at the cost of one "other" skill, or to Martial Arts or Assassin at the cost of two "other" skills.

R.C.C. Related Skills: Select six other skills. Plus select one skill at levels three, six, nine, eleven, and thirteen. All new skills start at level one proficiency.

Communications: Any (+10%)

Domestic: Any

Electrical: Any (+5%)

Espionage: Any (+10%)

Mechanical: Any (+5%)

Medical: Any (+10%); often selected for methods of torture.

Military: Any (+5%)

Physical: Any

Pilot: Any

Pilot Related: Any (+5%)

Rogue: Any (+5%)

Science: Any (+5%)

Technical: Any (+10%)

W.P.: Any

Wilderness: Any



Secondary Skills: The character also gets to select five secondary skills. These are additional areas of knowledge that do not get the advantage of the bonus listed in parentheses. All secondary skills start at the base skill level. Also, skills are limited (any, only, none) as previously indicated in the list.

Alliances and Allies: Most of the Fallam are loyal to the Freehold. Additionally, a few human and D-Bee servants have been assigned to minor guard duty and assist in other ways.

Weapons and Equipment: Arkhon hand computer and recorder, energy rifle and pistol of choice, a suit of combat armor, communicator, survival kit, survival knife, tools for torture (various knives, scalpels, laser scalpel, picks, needles, clamps, etc. and a medical kit if a doctor), 1D4 pair of handcuffs, and an archaic or modern weapon of choice.

Money: 2D6×1000 Arkhon credits (useful only within the Freehold).

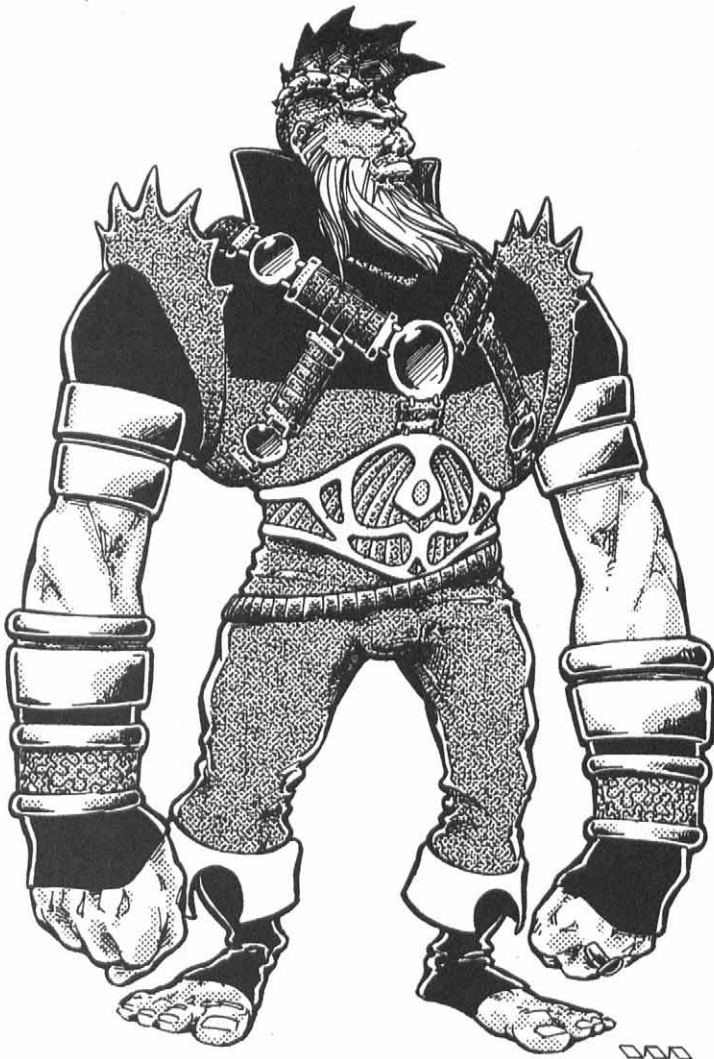

Fallam R.C.C.

The Fallam are a race of giant, minor M.D.C. beings who were conquered by the Arkhons centuries ago. After spending decades as slaves and then second-class citizens, the Fallam eventually became full-fledged members of the Arkhon community. These aliens had a close relationship to clan Tlo-Arkhon, and when that family left for Earth in exile, over four hundred thousand Fallam warriors and their families followed them (approximately 120,000 survived the failed invasion and serve the Arkhons of the Andes).

Typical Fallam are seven to nine feet tall, and have abnormally broad shoulders and almost ridiculously narrow hips and waists. The legs are also “abnormally” short in comparison with the arms. Pre-technological Fallam walked on all fours in a manner similar to Earth gorillas. Modern-day individuals can balance well on two feet, although they often lean on their hands, especially when resting without sitting down. Their skin is reddish-brown, and their hair is white or light yellow, and grows unevenly in thick tufts around the head, neck and back. Beards are not uncommon among males of the species. They also have a central fin and two bony ridges that run down the back of the neck, where they meet. The fin seems to suggest an amphibian origin, but the Fallam have been land dwellers since before they developed a civilization.

Originally, the Fallam culture was arboreal, having developed on a planet with dense tropical forests similar to the Amazon. They developed a high level of technology, nearly equal to pre-Rifts Earth, before the Arkhons’ conquest. Despite their size and strength, the Fallam were a relatively peaceful race, willing to find diplomatic solutions rather than resorting to war. Centuries of contact with the Arkhons have changed all that, making the Fallam as violent, competitive and militaristic as they are.

A significant percentage of the Fallam (3%) have the power to enter the Battle Trance, a near-mystical state in which they can shrug off pain and move with instinctive perfection and precision. Entering the Battle Trance is dangerous, because once it is over the warrior is severely weakened by the after-effects, but usually by that time there are precious few enemies left standing. These gifted warriors are known as the *Battlemasters* (see below). The rest of the Fallam are trained for a variety of jobs, from soldiering to technical skills. All Fallam within the Tlo-Arkhon family are soldiers with a technical sub-specialty and are greatly respected for their physical power and their stubborn savagery.

The Fallam on Rifts Earth have been faithful allies of the Arkhons for centuries. For the most part, they share the Arkhons’ goals and have nothing but hatred and contempt for humans. A small percentage are dissidents and renegades; Fallam who wish for the days when they were an independent race and seek revenge on the Arkhons. These rebels often desert, traveling as far as they can from the Arkhons’ domain. A small enclave of 32 adults, including two Battlemasters, escaped in a shuttle, not stopping until reaching North America. These renegades have joined a small D-Bee community in Tolkeen. They have enough technological knowledge to be an asset to that nation, but for the time being, they are hiding out, afraid to come forward, and so stay hidden among the members of the D-Bee village. Other rebels covertly sabotage the Arkhons’ plans of conquest. Sometimes, prisoners mysteriously escape when hatches and doors are “accidentally” left open, or a space fighter crashes when a small electronic component mysteriously “mal-functions.” Many an Inca and other human heroes have been saved through the actions of these saboteurs.

Alignment: Any, although most are evil; the majority (50%) are aberrant and completely loyal to the Arkhons.

Attributes: I.Q. 3D6, M.E. 3D6, M.A. 3D6, P.S. 4D6+16, P.P. 2D6+6, P.E. 2D6+16, P.B. 2D4, Spd. 3D6+6

Size: Average 8 feet (2.4 m) tall.

Weight: Average 400 lbs (180 kg)

M.D.C.: P.E. ×3, plus 2D4 per level of experience. S.D.C. bonuses from physical skills are added as M.D.C. equivalents.

Horror Factor: 8

P.P.E.: 3D6

Average Life Span: 150 years

Natural Abilities: Heal three times faster than humans (18 M.D.C. per day).

Experience Level: Average 1D4+1. Player characters start at the first or second level of experience.

Combat: By skill.

Damage: Supernatural P.S. See the *Rifts Conversion Book One*, page 22.

Bonuses: +2 on initiative, +1 to strike and parry, +2 to dodge, +2 to roll with impact, +3 to pull punch, +1 to save vs poison and disease, and +4 to save vs horror factor. These are in addition to skill and attribute bonuses.

Magic Powers: None.

Psionic Powers: Standard, same as humans.

Vulnerabilities/Penalties: None.

R.C.C. Skills:

Basic Radio (+15%)

Language and Literacy: Arkhon (98%) **Note:** The Fallam tongue is no longer spoken by this race; the Arkhons have destroyed most of their culture. Only a few scholars and rebels know that language.

Language and Literacy: One Earth language of choice (typically Spanish, Quechua or Aymara) (+15%)

Three Specialty Skills from the same field: choose from Electronic, Mechanic, Military, Piloting/Pilot Related, Scientific, Technical skills of choice (must include any prerequisites; +15% each)

Two related skills of choice (prerequisites or related to the above specialty; +10%)

W.P. Energy Rifle

W.P. Assault Rifle

Hand to Hand: Basic

Hand to Hand: Basic can be changed to Hand to Hand: Expert at the cost of one "other" skill, or to martial arts or assassin at the cost of two "other" skills.

R.C.C. Related Skills: Select 10 other skills. Plus select two additional skills at level three, and one at levels six, eight, eleven and fourteen. All new skills start at level one proficiency.

Communications: Any (+10%)

Domestic: Any (+5%)

Electrical: Any (+10%)

Espionage: Any (+5%)

Mechanical: Any (+10%)

Medical: Any (+5%)

Military: Any

Physical: Any

Pilot: Any (+5%)

Pilot Related: Any (+5%)

Rogue: Any

Science: Any (+10%)

Technical: Any (+10%)

W.P.: Any

Wilderness: Any

Secondary Skills: The character also gets to select six secondary skills. These are additional areas of knowledge that do

not get the benefit of the bonus in parentheses. All new skills start at the base skill level. Also, skills are limited (any, only, none) as previously indicated in the list.

Alliances and Allies: The Fallam are a client race to the Arkhons, and have no other allies on Earth. Even renegades are distrusted or even hunted down by the people of South America. The Fallam are sometimes mistaken for the mysterious race of Red Giants.

Weapons: TB-Prime or FR-5 rifle, and an energy weapon of choice.

Body Armor: Modified Arkhon Body Armor (same characteristics, but M.D.C. is 110).

Cybernetics: None

Fallam

Battlemaster O.C.C.

In Fallam mythology, it is said that a select few warriors made contact with ancient spirits and gods, and were gifted with the power to invoke the gods of war and have them inspire the warriors into performing heroic feats. *The Art of the Battle Trance*, as it was called, was practiced by only a tiny percentage of the Fallam before the Arkhons' conquest; the then-peaceful Fallam saw no need to keep alive those martial arts. The incredible prowess of those few (some of whom were able to destroy power armor in hand to hand combat) impressed the war-like Arkhons, and after the Fallam had been subdued, the few masters of these arts were given a great deal of respect and attention. After being dismissed by their own people, the Fallam Battlemasters basked in this new glory, and became one of the main supporters of the Arkhons.

Battlemasters now comprise an elite force within the Arkhons' armies. These deadly warriors are very few in number; in South America only have 1,500 of these masters are at their disposal. Due to their scarcity and value, the Battlemasters are not used in standard military formations, but instead have their own units, made up of 3-6 warriors, called Talons. Talons are typically deployed against other elite enemies, including True Inca demigods, Inca Warriors, dragons, etc. They also perform special missions such as sabotage, destruction of bridges and key facilities, and assassination. Battlemaster Talons often work alongside Spectral Hunter Squads and ESP Specialist teams. There is a spirited rivalry between the three elite groups, a rivalry that sometimes turns ugly. On a few occasions, prisoners have escaped or a fight was lost because one of the three groups refused to cooperate with the other two.

Although the Battlemasters are among the most loyal of the Fallam, there are rumors that a secret organization of these warriors, called the Inner Circle or just the Circle, has been plotting against the Arkhons since the Fallam conquest centuries ago. The Circle is said to include the oldest and best Battlemasters, and its plans are to undermine and one day, ruin the Arkhon race. Most people dismiss these rumors as fairy-tales.



Battlemaster Abilities and Bonuses:

1. Attribute Bonuses: The extensive physical training and body hardening Battlemasters endure grants the character +2 to P.S., +1 to P.P., +1D4 to P.E. and +1D4×10 M.D.C.

2. Combat Bonuses: Even without entering the Battle Trance, these warriors have mastered advanced combat techniques. +1 on initiative, +1 to strike, parry and dodge, and add one attack/action per melee. These are in addition to skill and attribute bonuses.

3. The Battle Trance: This mysterious ability may be psychic or magical in nature, or may involve some sort of mystic activity separate from either, possibly a gift from a deity or other supernatural power. Entering the trance is not done lightly, because when it is over, the warrior is weakened and dazed. While

it lasts, however, the Battlemaster becomes an amazing killing machine, removed from all normal concerns and emotions like fear or rage. When entranced the detached warrior moves at incredible speeds and strikes with deadly accuracy. The entranced battlemaster is immune to pain and fatigue, mental controls, and even most magic spells will not affect him!

Activating the Battle Trance: The character must concentrate for one full melee round (15 seconds). During that time the character can only defend against attacks at -2 to parry and dodge. Once activated, the trance will last one minute (four melee rounds) per level of experience. **Note:** The trance cannot be activated while wearing power armor or powered exoskeletons; only body armor can be worn.

Bonuses of the Battle Trance (Cumulative with all other Bonuses): +4 to initiative, +1 to strike, parry and dodge, +6 M.D. to hand to hand damage, +10 to spd attribute, and add *two attacks* per melee round. The character also temporarily gains and additional 1D6×10+10 M.D.C. (wounds suffered after body armor has been destroyed subtract from this M.D.C. first), and is immune to all forms of possession, mind control, charm, fear/horror factor and illusions, including psionic and magic. **Note:** The character is not berserk; he is free to choose the most logical targets and does so with a clear head.

Penalties of the Battle Trance: At the end of the trance, the warrior becomes weak and dizzy. The character has NO combat bonuses of any kind, only two melee actions/attacks per round, and all skills are at -25%. These after effects last for 1D4 minutes for every minute the character was entranced (i.e., a 3rd level Battlemaster who underwent the trance for the full 3 minutes will be weakened for 3D4 minutes afterwards).

Fallam Battlemaster O.C.C.

Alignment: Any, but aberrant is the most common (65%).

Attribute Requirements: P.S. 22 and P.P. 16; open to the Fallam R.C.C. only.

O.C.C. Skills:

- Language and Literacy: Arkhon (98%)
- Language and Literacy: One Earth language of choice (+15%)
- Basic Radio (+10%)
- Prowl (+15%)
- Detect Ambush (+15%)
- Wilderness Survival (+10%)
- W.P. Sword
- W.P. Energy Rifle
- W.d to Hand: Martial Arts

O.C.C. Related Skills: Select seven other skills. Plus select an additional skill at levels three, five, seven, ten, twelve and fourteen. All new skills start at level one proficiency.

- Communications: Any (+10%)
- Domestic: Any
- Electrical: Any
- Espionage: Any (+10%)
- Mechanical: Any
- Medical: Paramedic or First Aid only.
- Military: Any (+10%)
- Physical: Any (+5% where applicable).
- Pilot: Any (+10%)
- Pilot Related: Any (+10%)
- Rogue: Any (+5%)

Science: Any
Technical: Any (+5%)
W.P.: Any
Wilderness: Any (+5%)

Secondary Skills: The character also gets to select six secondary skills. These are additional areas of knowledge that do not get the benefit of the bonus listed in parentheses. All new skills start at the base skill level. Also, skills are limited (any, only, none) as previously indicated in the list.

Standard Equipment: TB-Prime or FR-5 rifle, and an energy weapon of choice, Tri-blade energy sword, modified Arkhon Body Armor (same characteristics, but M.D.C. is 110), and survival kit. Additional equipment may be made available for special missions.

Money: 2D6×1000 Arkhon credits.

Cybernetics: None

Arkhon Weapons & Equipment

Three elements make Arkhon technology fairly unique in the Megaverse. While not incredibly advanced compared to such areas as the Splugorth domains and the Three Galaxies, the Arkhons have developed a number of specialized technologies that few others have matched.

The first element is cultural rather than technological. Most Arkhon vehicles, robots and armor suits have a cyclopean motif, particularly a single central eye over the vehicle or armor's "face." This motif is due to the existence of a semi-intelligent predator on the Arkhon homeworld, a large, heavily muscled one-eyed creature larger than an Earth gorilla and with the ruthlessness and thirst for blood of a leopard. The Arkhons were in awe of this creature, called the **Un-Mertak** (Death Cyclops), for most of their early history. With the development of technology, the Arkhons hunted the Death Cyclops into near extinction, to the point that at the time of the second invasion only a few hundred of the creatures still existed, all of them in captivity. Regardless of this, the Arkhons have always used a cyclops-like style in their artistic designs, including weapon decoration. When designing power armor, some scientists decided that a single central sensor system was easier to design than one mimicking binocular vision. Most Arkhon systems follow this pattern.

The second advance came in the field of energy weapons. The Arkhons developed and discarded lasers centuries ago; they decided the light beams were too easy to deflect, block out and defend against. Instead, they focused on particle beam and plasma weapons. Their greatest breakthrough was the creation of a combined beam that shared characteristics of lasers, ion beams, plasma and other charged particles. The result was called a *tri-beam*.

Tri-beams form a composite energy discharge, traveling along an ionized path created by an invisible ionizing laser nanoseconds before the visible, mixed energy blasts. The visual effect is impressive, as three beams of energy appear to jump out of the multi-barreled gun and then intertwine around each other! Even more impressive is the effect they have on targets. The charged particles break down molecular bonds, and plasma burns down the weakened matter. As a result, tri-beams do double damage to most materials, although they do normal damage to both technological and magical force fields. Only the special ceramic/plastic composite armor they've developed, called *Cerasteel*, defends adequately against the triple threat.

Cerasteel was designed specifically for use against the devastating tri-beams. The materials of the armor plates were designed to dissipate direct energy attacks. The resulting composite armor halves the power of most energy weapons (and neutralize the tri-beam's double damage). The main drawback is that the composite material is relatively fragile against physical impacts, such as bullets, missiles, rail guns, robot punches and kicks, etc. Such impacts can eventually shatter the armor. This means, Arkhon armor takes only normal damage from most energy beams (except tri-beams, which do half damage, and exotic weapons like phase beams, which are not affected by material barriers), but takes double damage from physical attacks. Explosions have concussive waves that are evenly spread by the ceramic/plastic composite, so most explosive attacks do normal damage to Arkhon armors unless struck directly by a missile. Missiles that impact on the armor do double damage.

Arkon E-Clips

The Arkhons have their own equivalent of Earth's E-clips. The alien version is slightly smaller and lighter, and it has roughly the same energy capacity as Earth types. Earth E-Clips will not function in Arkhon weapons and vice versa, unless a competent armorer makes a successful *weapons engineer* roll at -20% to jury-rig connections. Even then, a normal E-clip will only hold two-thirds the normal energy an Arkhon clip would; this is due to the energy that is lost through the improvised connections.

In the last couple of years, the Arkhons have captured enough territory, tools, weapons and factory equipment to make them want to use terran E-clips on their weapons. Warlord Enno realizes his people are stuck on the planet for centuries, and that the ships' mini-factories cannot cope with the demands of a centuries-long campaign of warfare and conquest. Thus, a small factory using stolen Earth equipment is producing normal E-clips and about 20% of all Arkhon weapons have an adapter to use Earth E-clips built into them. This adapter can accommodate normal Earth E-clips without any loss of energy and performance. If the players capture any Arkhon weapons, the Game Master should roll percentiles: 1-20 means the weapon has an adapter; 21-00 means it doesn't and must use Arkhon E-clips or be customized as noted above.

Hand Weapons

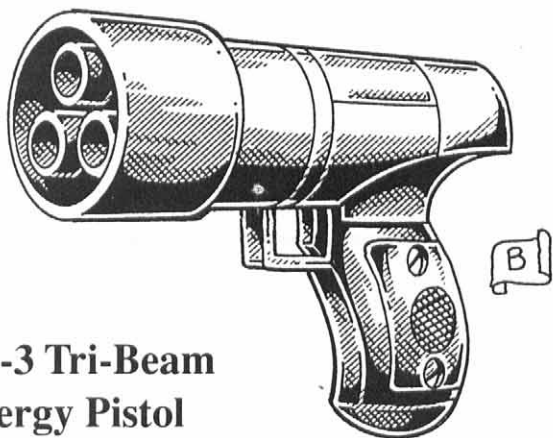

TB-3 Tri-Beam Energy Pistol

The Tri-Beam or "TB" pistol is a relatively stubby, short-barreled weapon, easily confused for a flashlight with a pistol grip. It has the characteristic three barrels of all tri-beam weapons, but they only extend about two inches from the firing mechanism. The pistol grip is slightly curved and made to fit the hands of the Arkhons. Humans using them will find the grip new and unfamiliar, but can easily get used to them (-1 to strike until the user practices for 1D4 hours).

The TB pistol is not very powerful or long-ranged. It is issued to support personnel (clerks, mechanics, medics) and others in noncombat positions. The Arkhons even use the weapon as a trade item among the few D-Bee communities that do business with the aliens. Traded guns will have an E-clip adapter, but have a self-destruct system that will detonate if someone tries to tamper with its outer casing (whether to repair or disassemble the weapons). This is done to prevent outsiders from learning the secrets of tri-beam technology. Most Arkhon soldiers prefer the more powerful TB-9 pistol, which is never used as a trade item.

Weight: 2 lbs (0.9 kg)

Mega-Damage: 2D4 M.D.; double damage to most materials, except force/energy fields and Arkhon composite armor.

Rate of Fire: Can only fire single shots (each counts as one melee attack); no burst capability.

Effective Range: 500 feet (152 m)

Payload: 15 shots

Cost: 12,000 credits; poor availability outside areas under Arkhon influence.

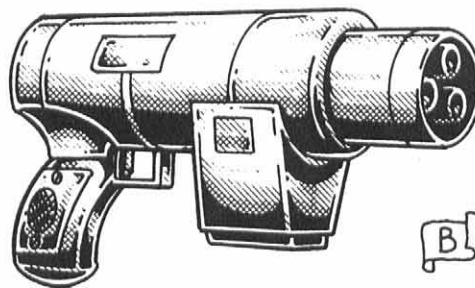

TB-9 Auto-Pistol

This heavy weapon could be classified as a heavy pistol or a sub-machinegun. It is big enough to be used two-handed (although most Arkhons believe a "true male" should fire the gun one-handed), has a large capacity, and packs a powerful energy blast. TB-9's are issued to officers, pilots and vehicle crews, as well as military police and intelligence units. The weapon does not have the range or the penetration power of a true combat rifle, but is a close second, as well as being compact enough to be carried and stored more easily.

Weight: 5 lbs (2.25 kg)

Mega-Damage: 4D6 M.D.; double damage to most materials, except force/energy fields and Arkhon composite armor.

Rate of Fire: Standard.

Effective Range: 1200 feet (365 m)

Payload: 30 shots

Cost: Not normally sold. Captured weapons can cost anywhere between 30,000 and 90,000 credits; add 50% to the price if the weapon has an adapter for use with Earth E-clips.

TB-Prime Tri-Beam Energy Rifle

The Prime TB Rifle is the pride of the Arkhon armies. A solid, dependable battle rifle, this weapon sports a tri-beam system over a semi-automatic grenade launcher with a three round clip. Every infantryman in the Arkhon army has the capability to shell enemies with indirect fire thanks to the grenade launcher, and the tri-beam blasts will chew through most materials if given enough time. These weapons have become known as "demon rifles" among the people of the Andes, and are widely feared.

Weight: 10 lbs (4.5 kg)

Mega-Damage: 5D6 M.D.; double damage to most materials, except force/energy fields and Arkhon composite armor.

Grenades: 4D6 M.D. to a 12 foot (3.65 m) area.

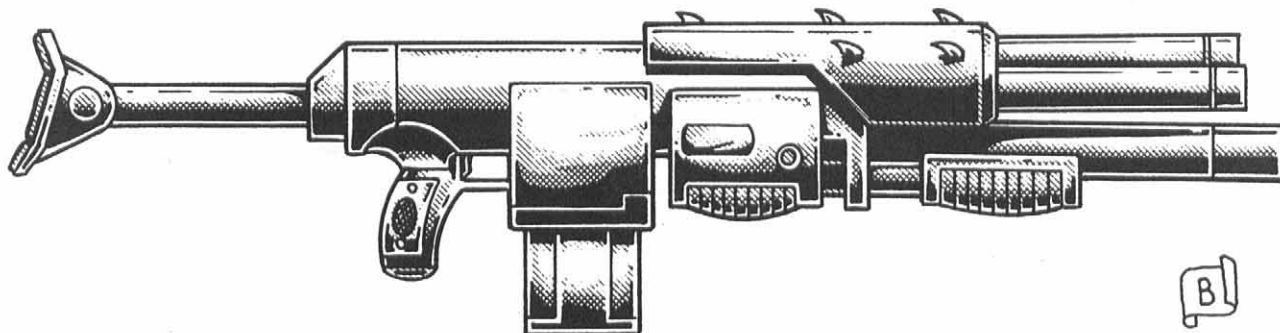

Rate of Fire: Standard.

Effective Range: 2000 feet (610 m)

Payload: 30 tri-beam blasts, and 3 grenades.

Cost: Not for sale. The few captured rifles can be purchased (if available) for 60,000 to 160,000 credits. Add 30% if the weapon has an adapter for Earth E-clips.

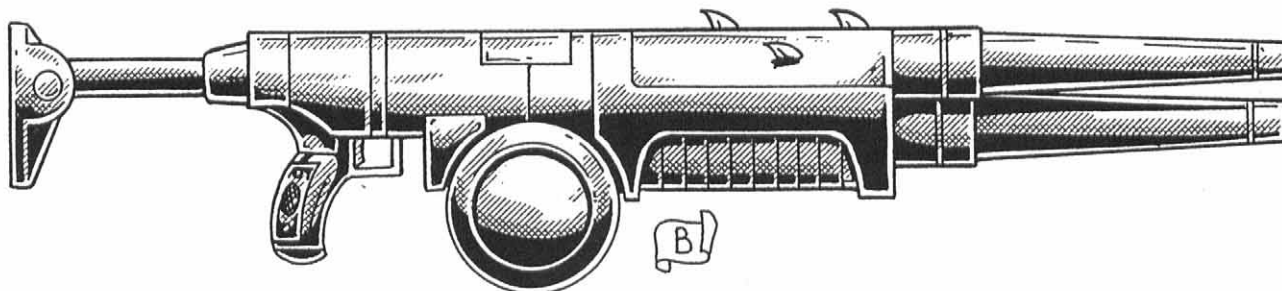

M-100 Tri-Beam Crew Served Gun

This support weapon uses an extended energy clip; roughly equivalent to the Coalition's Canister E-clip or Triax's FSE-Clip, but even more powerful. The weapon is the equivalent of a medium machinegun and is typically carried by a team of two (one carries the weapon, the other has extra ammo in addition to a TB-9 auto-pistol); fired from a bipod rest. Cyborgs and soldiers in power armor can use this weapon instead of a standard rifle. The M-100 can chew through the front armor of a main battle tank with a few long bursts, and its long-range makes it a favored support weapon.

A combat squad of 10 Arkhon infantrymen will have one M-100 (and either one BM-2 or one BRL-3 respectively) for close support; the M-100 is sometimes replaced with a FRA-1

flechette machinegun. Combined with the fact that one-third of all combat soldiers wear exoskeletons, these weapons give the Arkhons enormous advantages in firepower over most enemies.

Note: This weapon does not have an adapter, and will not accept either Arkhon or Earth standard clips. A specially *jury-rigged* clip will only provide the weapon with 15 shots if using an Arkhon clip or a mere 10 with an Earth clip.

Weight: 21 lbs (9.4 kg)

Mega-Damage: A single shot inflicts 5D6 M.D.; a three round burst does 1D4×10+10 M.D., double damage to most materials, except force/energy fields and Arkhon composite armor.

Rate of Fire: Standard burst firing.

Effective Range: 3000 feet (914 m)

Payload: 60 shots in an extended magazine.

Cost: Rarely available for sale; price starts out at 130,000+ credits.

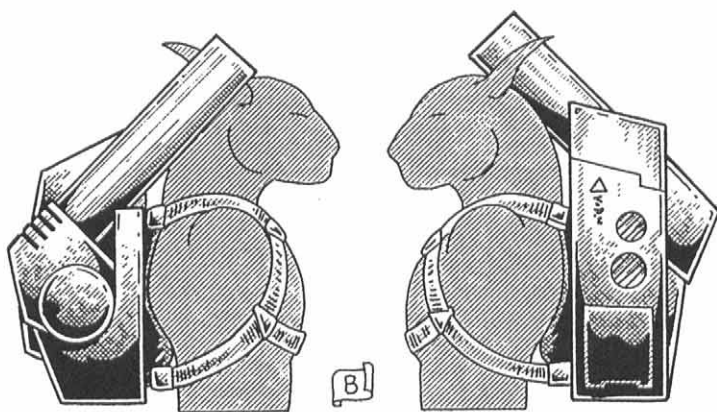

BM-2 Backpack Mortar System

The BM-2 is worn just like a backpack. The system has a launch tube and a mortar magazine, and it is linked electronically to a HUD (Heads-Up Display) on the Arkhon's helmet visor. Basically, when the gunner wishes to activate it, he can verbally give the system a range and coordinates, and the launch

tube will orient itself and fire in that direction. The mortar is useless against targets closer than 300 feet (91 m), but it has a range of nearly two miles (3.2 km)! The mortar-carrier can use information given by forward observers or other soldiers. People who have started shooting at Arkhon soldiers have discovered that mortar shells will start raining down on them within a minute (1D4 melee rounds) after the start of a fight.

The bomblets can be shot at like normal missiles (see *Rifts RPG*, page 42). They have 1 M.D.C. each. The only problem is that the bomblets are very small and hard to spot. Unlike missiles, they have no contrails to indicate their position; a called shot is at -4 to strike.

Arkhon mortars are far more advanced than Earth equivalents. Although they can fire conventional "dumb" mortar rounds, most units are equipped with smart bombs that have an electronic guidance system and fins that control their trajectory. These smart bomblets will zero in on humanoid or vehicular targets with frightening accuracy (+3 to strike!). Fortunately for the Empire of the Sun, the Arkhons are having trouble manufacturing enough *smart* bomblets to keep up with the expenditures, so only about 30% of the mortar's ammo will be of this sort.

Weight: 30 lbs. (13.5 kg)

Mega-Damage: Dual-purpose mortar round. The shooter can electronically “prime” the rounds before firing them, selecting either fragmentary or anti-armor. In the first mode, the bomblet detonates in the air, 8 feet (2.4 m) before hitting the ground, and showers the area with lethal fragments. In the second mode, the bomb explodes on impact, with a minimal blast radius but maximum damage to the target.

Fragmentary Bombs: 3D6 M.D. to a 20 foot (6.1 m) radius.

Anti-Armor: 6D6 M.D. to a 2 foot (0.6 m) radius.

Rate of Fire: Single shot, burst of three, or long burst of six. Each counts as one melee attack.

Effective Range: Up to 2 miles (3.2 km).

Minimum Range: 300 feet (91.4 m)

Payload: 18 bomblets in the magazine. Reloading the magazine takes 5 minutes. Changing magazines (spares are loaded on trucks or similar cargo vehicles) takes one melee round for two people or four melees for one.

Cost: 120,000 to 200,000 credits. Smart bombs cost 3,000 credits each; rarely available outside the Arkhon Army.

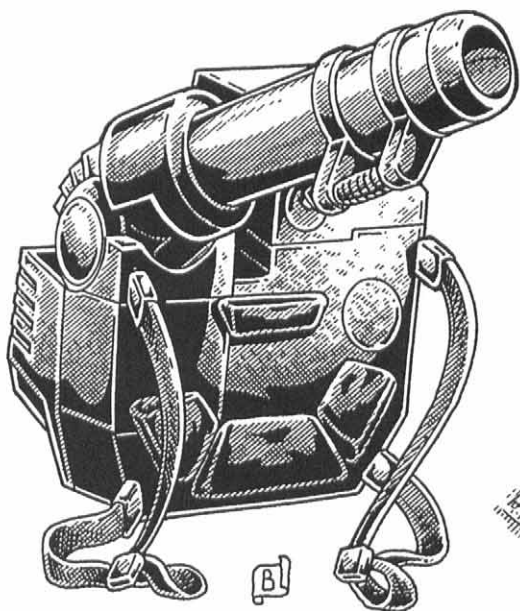

BRL-3 Backpack Rocket Launcher

The last of the “terrible trio” of Arkhon infantry support weapons, the BRL-3 is designed for use against armored vehicles and as a direct and indirect fire weapon. The missiles are equally effective blowing up buildings and bunkers as they are stopping giant robots and tanks. The weapon consists of a rocket tube on the right side of the backpack, and a missile rack contained in the “backpack.” The weapon can be used in two modes: guided and direct.

On guided mode, the rocketeer simply designates a target through an aiming point projected into the face-plate of his helmet. When he lines the electronic cross-hairs on the target, the missile launches itself from the backpack and arcs towards the target (+3 to strike).

On direct fire mode, the soldier lifts the tube and fires it over the shoulder like a bazooka (use the soldier’s W.P. bonuses for aimed fire). Direct fire is limited to line of sight, but tends to be more accurate at short range. The big advantage of guided mode

is that any member of a squad can act as a target designator. Thus, the missileer could be hundreds of feet behind the lines, and a soldier far ahead could target an enemy vehicle or formation for the rocket launcher. To reload, the soldier has to “re-chamber” the tube into the backpack (takes one melee attack/action to reload in either mode).

The missiles are slightly more powerful than conventional mini-missiles, and have the advantage of being guided. Of late, the Arkhons have found themselves unable to keep up with the demand for guided missiles, and have to rely on easier to produce “dumb” missiles (can only be used in the direct fire mode). Even so, they are a very effective weapon. Every Arkhon squad (10 soldiers) has one backpack weapon, either the mortar (see above) or the rocket launcher.

Captured rocket launchers are being used and copied by the human nations of Cordoba and Santiago (see the **SRR** section for more details). These knock-offs substitute the Arkhon rockets with conventional mini-missile launchers (use the stats from the *Rifts RPG*), and can only be used in direct fire mode, with reduced range.

Weight: 30 lbs. (13.5 kg)

Mega-Damage: 2D4x10 M.D. for a direct hit, plus inflicts 4D6 M.D. to an additional 10 foot (3.0 m) radius around the strike point.

Rate of Fire: Each missile shot counts as one hand to hand attack. Cannot fire volleys.

Effective Range: **Guided:** 5 miles (8 km). **Direct Fire:** Line of sight to 2000 feet (610 m).

Payload: 12 rockets; each is about twice the size of a grenade.

Cost: 150,000 credits; rarely available. Cordoba and Santiago copies carry only 6 mini-missiles and cost 100,000 credits.



Tri-Blade Energy Sword

When deactivated, this weapon looks like a sword handle with three long, thin wires protruding from the hilt instead of a blade. The flick of a button creates a tri-beam charge that runs up the connecting wires, and turns into an energy blade that can slice through most alloys and construction materials with ridiculous ease. The tri-blade sword is assigned to officers, but many soldiers purchase a personal blade as a badge of courage, despite the fact that hand to hand combat is very rare in modern combat.

Weight: 3 lbs. (1.35 kg)

Mega-Damage: 3D6 M.D.; double damage to most materials, except force/energy fields and Arkhon composite armor.

Rate of Fire: Hand to hand combat only.

Effective Range: Hand to hand melee weapon.

Payload: An Arkhon E-clip powers the weapon for eight hours of continuous use; every time the sword is activated, it consumes a minimum of one minute’s worth of energy even if the sword is turned off in less than a minute.

Cost: Rarely available; 50,000 credits or higher.

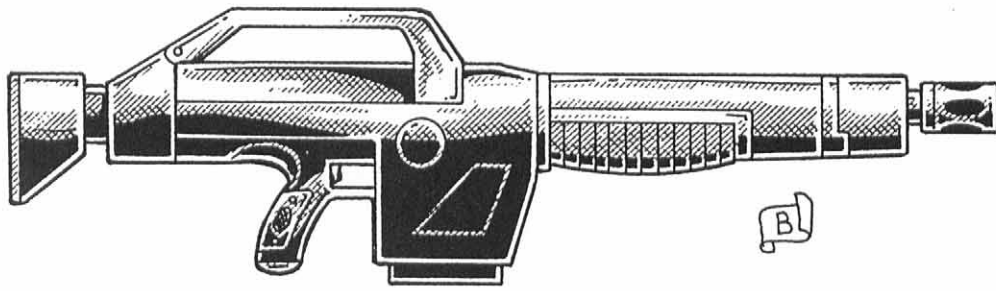

FR-5 Flechette Rifle

Despite the effectiveness of their tri-beam technology, the Arkhons don't like to rely on only one type of weapon. Energy beam weaponry have their shortcomings, among them the fact that some foes may be resistant or immune to them. To guard against this eventuality, the Arkhon equip about 30% of their troops with flechette rifles. These weapons use antigravity beams to accelerate aerodynamic flechettes (miniature arrows) at astronomical speeds. The FR-5 fires cartridges loaded with 10 of these flechettes, much like a shotgun shell. Each flechette has enough penetration to bore through M.D.C. armor and ten of them will tear through armor and the flesh beneath with horrify-

ing ease. Furthermore, these weapons exploit the weaknesses of Arkhon body armor, and do double damage to those armor suits (a necessity when facing one's own kind in battle).

Weight: 15 lbs. (6.8 kg)

Mega-Damage: 6D6 M.D. per shot.

Rate of Fire: Single shot only. Wild "bursts" spread the flechettes over an area, doing 2D4 M.D. to each target hit.

Effective Range: 1200 feet (365 m)

Payload: 20 shot box magazine.

Cost: Poor availability. Would be around 30,000 credits outside the Arkhon Freehold.

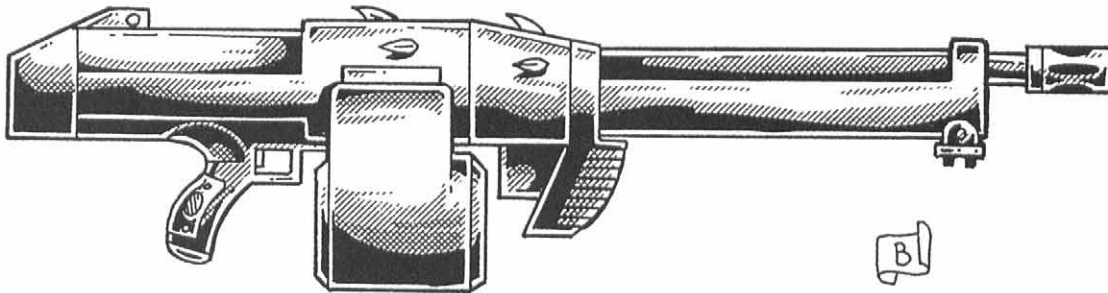

FRA-1 Flechette Auto-cannon

The flechette machinegun/auto-cannon is a support weapon that fires heavier ammo than the FR-5 rifle from either a drum magazine or a disintegrating belt. FRA-1s are used as squad weapons, or carried by powered armor and cyborg soldiers as a "rifle." They are also mounted on light vehicles, especially captured Earth vehicles that need extra armament. The FRA-1 cannot be fired from the shoulder or hip unless the wearer has a natural P.S. of 24, a supernatural P.S. of 18, or is a cyborg or

wearing a power armor with a P.S. of 20 or higher.

Weight: 30 lbs. (13.5 kg)

Mega-Damage: 1D4×10 M.D. per shot. A burst is 10 rounds and does 2D6×10+10 M.D. The burst can be used to spray an area, doing one shot damage to affected targets.

Rate of Fire: Standard.

Effective Range: 4000 feet (1220 m)

Payload: 30 round drum magazine or 200-round belt.

Cost: 80,000 credits or more; rarely available outside the army.

Robots & Power Armor

Arkhon Body Armor

All Arkhon body armor uses advanced ceramics that take half damage from all energy weapons, but double damage from physical attacks (bullets, direct hits from missiles, supernatural and robot M.D. punches, magic weapons, and similar impacts). Explosive concussion and the impact from a fall does normal damage, but direct hits from missiles do double damage.

Pilots and rear-echelon soldiers, like sensor operators, communication experts, etc., are all assigned a suit of sealed, non-powered battle armor. About two-thirds of line soldiers wear the same armor; the other third use **Stormwind Assault Exoskeletons** (described in this section). All Arkhon armor is painted red; captured suits are often repainted to avoid being mistaken for dangerous alien invaders.

The armor is designed to fit the Arkhon's bodies, so normal humanoids can wear pieces of captured Arkhon armor, but the result is not airtight and areas of the body are exposed (A.R. 17, M.D.C. 75 if worn by a human). An expert armorer could refit the armor so a human wearer gains the full benefit, but one problem remains; repairing the armor. Since no Earth culture knows how the ceramic-plastic composite is created, armor patches will be made of traditional M.D.C. alloys. These repairs can only replace 60% of the damage (i.e., if a suit of armor took 10 M.D.C. points' worth of damage, ordinary repairs will only bring back 6 M.D.C. points), and after more than 30 M.D.C. points are replaced, the armor loses its special advantages. The armor has all standard accessories plus the following:

- M.D.C.: 85
- Weight: 20 lbs (9 kg)
- Excellent mobility; -5% prwl penalty.
- Market Cost: Poor availability outside the Arkhon Freehold. Cost ranges from 40,000 credits to 60,000 credits for a modified, ready to wear suit (usable by humans with no penalty).

Stormwind Assault Exoskeleton

About one-third of all Arkhon line soldiers are equipped with this suit, a light exoskeleton with many of the features common to power armor. The suit has flying capabilities, which basically means that a sizable percentage of the Arkhon army can be airborne without need of transport vehicles. Although it is less well armored than most suits of power armor, and does not have the enhanced speed and reaction times that most normal power armor systems have, (no Power Armor Combat bonuses apply), the Stormwind is still a near-match to most light and medium suits.

The Stormwind is the standard issue body armor given to a combat unit. Pilots and rear-echelon soldiers (i.e., those involved in communications, sensors and other non-combat duties) are assigned non-powered armor suits (see above). For additional support, heavier power armor like the Ghost Wasp and the Death Cyclops (see below) are available to specialized armored squads in assault or support missions.

The suit has an integral tri-beam pistol built into the forearm to serve as a back-up should the soldier lose his standard issue weapon. Most troopers carry a tri-beam rifle and 20% carry a heavier weapon, such as a crew-served gun, a backpack mortar or rocket launcher (these weapons are built to fit over the Stormwind antigravity system). Another 10% carry a heavy flechette rifle (see the FRA-1 flechette auto-cannon for stats).

Despite its shortcomings, the suit is coveted by the human kingdoms in the area, mainly because they wish to reproduce its antigravity system. So far, attempts to study or copy the armor's systems have failed. The technology used is so advanced and alien that the SRR scientists are at a loss. It is possible that a larger scientific community like Triax *might* be able to crack the secrets of antigravity, but even after (or if) the NGR gets access to this armor it would take decades. In any case, captured suits of armor with minor damage can be sold in the South and Central American republics for incredible prices. The only problem is getting the armor from Arkhon soldiers; most of whom will

not part with them willingly, and who usually travel in well-armed groups.

Model Type: LE-457S

Class: Armored Infantry Light Exoskeleton

Crew: One

M.D.C. by Location:

* Head — 50

** Antigravity System (built-in, on back) — 40

**** Side Wings (2) — 60 each

*** Main Body — 150

* Destroying the head/helmet has an 80% chance of knocking the pilot unconscious. If conscious, the wearer's head is now vulnerable to attack, and all the sensor and communications gear in the helmet are lost.

** The Antigravity System can only be targeted when the wearer is facing away from the shooter. Even then, it requires a called shot at -4 to hit the system. Depleting its M.D.C. makes flying impossible! If the target was airborne when the suit was destroyed, he will crash, falling from the sky like a rock.

*** Depleting the M.D.C. of the armor will shut it down, rendering it useless and burns out the antigravity system.

**** The side wings are mostly ornamental, although they are helpful in steering the suit. Destroying them reduces maximum speed by 5% and maneuverability by 10%; destroying both doubles these penalties.

Remember, energy weapons do half damage, but kinetic weapons (bullets, fists, direct hits from missiles, etc.), do double damage.

Speed

Running: 50 mph (80 kmph) maximum. Note that the act of running does tire out its operator, but at 30% of the usual fatigue rate thanks to the exoskeleton.

Flying: 200 mph (320 kmph) maximum speed. Cruising speed is typically 80-100 mph (120 -160 kmph). The antigravity system allows the wearer to make very tight turns, stop on a dime, and other aerial acrobatic feats. Furthermore, there is NO limit to the altitude the suit can achieve. It can even escape Earth's atmosphere and reach outerspace.

Statistical Data

Height: Personally fitted; adds 4 inches (10 cm) to character's height.

Width: 4 inches (10 cm) wider than normal.

Length: 2 inches (5 cm) longer than normal.

Weight: 150 lbs. (67.5 kg) for the suit.

Physical Strength: Equal to a P.S. 22

Cargo: None.

Power System: Long-life battery; average energy life is 2 years (the technology is exclusive to the Arkhons and would take 2D4×10 years to duplicate on Rifts Earth).

Market Cost: Not for sale. Captured suits typically sell for 1-2 million credits, depending on the state of repair, energy life remaining, and similar factors. If they knew about the suit and antigravity flight system, weapons manufacturers like the CS, Northern Gun, Triax, the Splugorth, and Naruni Enterprises would pay as much as 5 million for a new, undamaged and complete suit.



Weapon Systems

1. Tri-Beam Wrist Pistol: This is a built-in TB-9 pistol, used as a back-up weapon.

Primary Purpose: Anti-personnel

Secondary Purpose: Defense

Mega-Damage: 4D6 M.D.; double damage to most materials, except force/energy fields and Arkhon composite armor.

Rate of Fire: Standard

Effective Range: 1200 feet (365 m)

Payload: Effectively unlimited.

2. Primary Weapon: Stormwind troopers are assigned a primary rifle or heavy weapon. Typically, the weapons carried include: TB-Prime Rifles (60%), FR-5 Flechette Rifles (15%), M-100 Energy Machineguns (10%), BM-2 Mortars (5%), BRL-3 Rocket Launchers (5%), and FRA-1 Auto-cannon (5%).

3. Hand to Hand Combat: No special bonuses, but the suit enables the wearer to inflict 2D6+7 S.D.C. and 4D6+7 S.D.C. from kicks. In addition, the wearer can carry heavy loads at a fraction (30%) of the usual rate of fatigue.

Ghost Wasp Aerial Power Armor

This heavy power armor suit vaguely resembles a humanoid insect, more like a dragonfly than a wasp, complete with two pairs of wings and a “stinger” on the lower torso. Ghost Wasps are the “stealth bombers” of the Arkhon armies. The suits are equipped with an advanced chameleon system that makes them nearly invisible to both visual and radar sensors. The only shortcoming is that the energy cost of the chameleon field allows only for slow flying and no use of weapons. To attack or maneuver at full speed, the pilot must drop the complex holographic projection and become visible. Still, these suits often provide their pilots with the element of surprise, allowing them to close in and then attack enemies at point-blank range before they are even aware of their presence. Ghost Wasps are also ideal for scouting and special missions in which stealth is more important than firepower.

Ghost Wasps are used in combined groups (usually supporting infantry units) or as special Wasp Squadrons made up exclusively of this power armor. While supporting infantry, the Ghost Wasps fly close to the ground, strafing enemy targets, or landing to fight side by side with the Arkhon “grunts.” Squadrons are used to spearhead large-scale attacks, using their stealth to damage or destroy anti-aircraft guns, tanks, artillery and robots. Whenever you spot more than three in one group, you can be certain that a large-scale attack is heading your way!

The Ghost Wasp’s “stinger” is actually a tri-beam cannon. Mini-missile launchers on the sides and a heavy flechette gun complete the armament of this suit. The armor can be reconfigured as a bomber and armed with as many as four long-range missiles, at the cost of the flechette rifle and reduced speed and maneuverability until the missiles are launched. These bomber models have been responsible for the deaths of thousands of Inca civilians. The Ghost Wasps have penetrated deep into Imperial territory and launched the missiles into city streets, killing and wounding innocents in an effort to break the Incas’ will. Cap-

tured Wasp pilots are usually called “baby killers” and summarily executed.

Model Type: APA-III

Class: Stealth-Capable Aerial Assault Exoskeleton

Crew: One

M.D.C. by Location:

Wings (4, 2 per side) — 100 each

Mini-Missile Launchers (2, between wings) — 90 each

Flechette Rifle — 130

Stinger/Tri-Beam — 90

* Head — 100

** Main Body — 350

* Destroying the head of the power armor will eliminate all forms of optical enhancement and sensory systems. The pilot must now rely on his own vision and senses: no power armor combat bonuses to strike, parry and dodge! The head is a small and difficult target, requiring a called shot at -4 to strike.

** Depleting the M.D.C. of the main body destroys the suit, making it useless. Reducing the M.D.C. by 50% knocks out the cloaking system.

Remember, energy weapons do half damage, but kinetic weapons (bullets, M.D. fists, magic arrows, direct hits from missiles, etc.), do double damage.

Speed

Running: 50 mph (80 kmph)

Flying: 600 mph (960 kmph); cruising speed is 100-300 mph (160-480 kmph), depending on the mission. Note: The Stealth System cannot be engaged if the Ghost Wasp is flying much faster than 100 mph (160 kmph; the stealth system automatically disengages at 101 mph/162.5 kmph). The antigravity system allows the wearer to make very tight turns, stop on a dime, and other aerial acrobatic feats. Furthermore, there is NO limit to the altitude the suit can achieve. It can even escape Earth’s atmosphere and reach outerspace.

Range: The nuclear power system has decades of life, but the jet system needs a chance to cool down after six hours of flying above cruising speed (300 mph/480 kmph) or 15 hours at cruising speed or below.

Statistical Data

Height: 7 feet (2.1 m) standing.

Width: 4 feet, 7 inches (1.4 m).

Length: 14 feet (4.25 m) from head to tip of stinger.

Weight: 1 ton fully loaded.

Physical Strength: Equal to a P.S. 35

Cargo: None.

Power System: Nuclear; average energy life is 20 years.

Market Cost: Not for sale. Available only at the Arkhon Freehold. Captured and patched suits can be found in some areas of South America; typically they have 20% less M.D.C. and are missing one or two major weapon systems. These second-hand suits cost 7-10 million credits.

Weapon Systems

1. Flechette Gun: This is a rifle-shaped version of the FRA-1 auto-cannon. The weapon is fed from a back-mounted magazine, and is used primarily against armored vehicles or massed infantry. When sent out on terror missions, the pilots “hose” an area with flechettes; the result is like hard rain on soft sand — except the “sand” in question includes concrete sidewalks, buildings, and unarmed civilians.

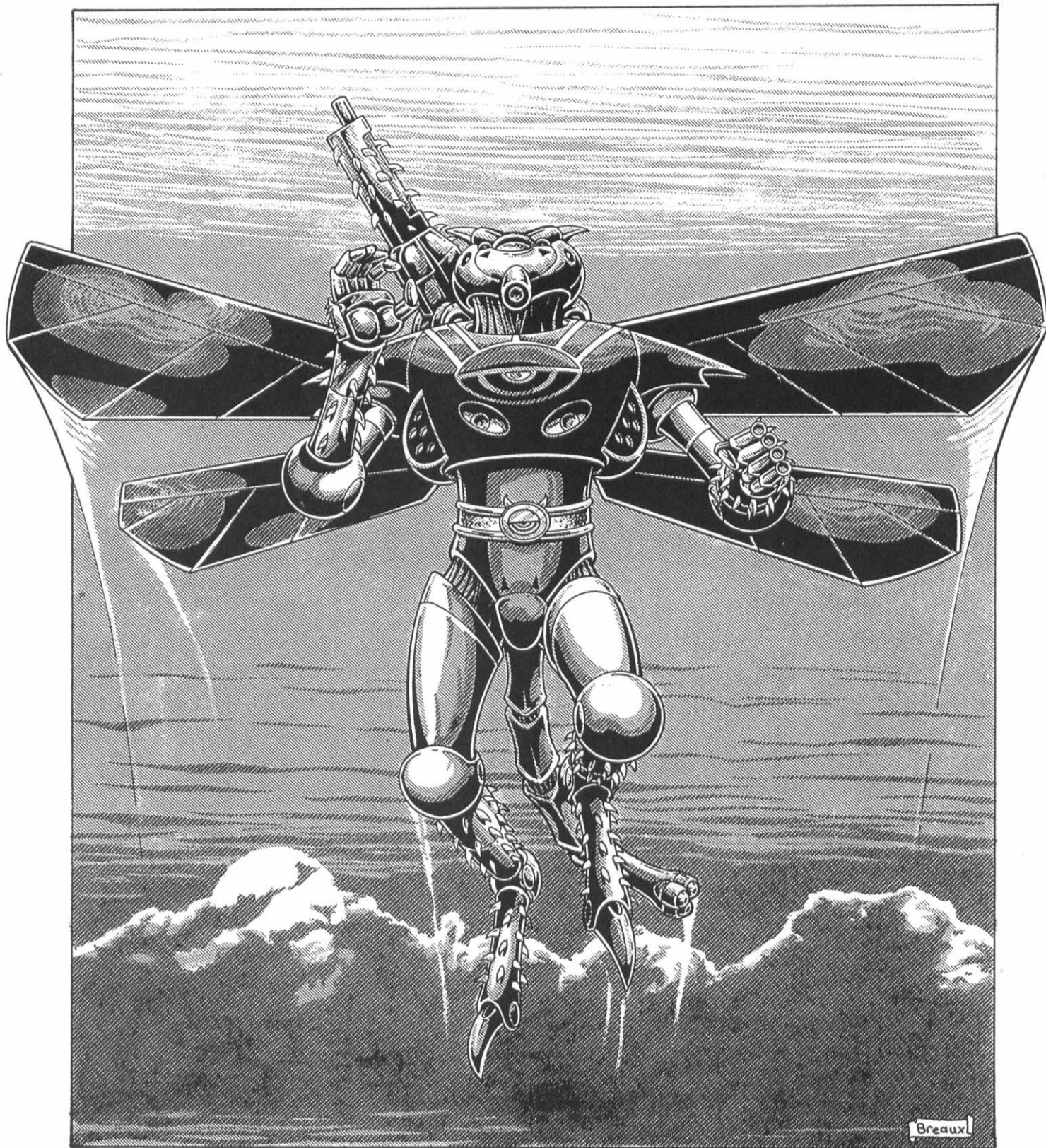

Primary Purpose: Anti-armor and anti-personnel.

Secondary Purpose: Defense

Mega-Damage: 1D6x10 M.D. per shot. A burst is 10 rounds and does 2D6x10+10 M.D. The gunner can hose the area with the flechettes; a burst covers a 30 foot (9.1 m) radius and inflicts 3D6 M.D. on everything in the area!

Rate of Fire: Standard.

Effective Range: 4000 feet (1220 m)

Payload: The gun is belt-fed from a 400 round magazine on the back.

2. Tri-Beam Stinger: A medium tri-beam cannon, slightly more powerful than the M-100 crew-served weapon. The stinger is the main anti-armor weapon, and is also used in dogfights against flying vehicles or power armor.

Primary Purpose: Anti-aircraft and anti-armor.

Secondary Purpose: Defense

Mega-Damage: A single shot inflicts 6D6 M.D.; a 3 round burst does 2D4x10 M.D., double damage to most materials, except force/energy fields and Arkhon composite armor.

Rate of Fire: Standard.

Effective Range: 3000 feet (914 m)

Payload: Effectively unlimited.

3. Side-Mounted Launchers: Two mini-missile launchers, each with eight mini-missiles, are mounted between the double wings. When spearheading an attack, or when ambushing a large enemy formation, Wasp squadrons often “ripple-volley” their entire missile payload — 16 missiles per Wasp, resulting in as many as 320 mini-missiles raining down on the surprised enemies!

Primary Purpose: Anti-aircraft

Secondary Purpose: Defense

Mega-Damage: Varies; commonly uses plasma (1D6x10 M.D.).

Rate of Fire: One at a time, or volleys of two, four, eight or sixteen.

Effective Range: About one mile (1.6 km).

Payload: 16 total; 8 per launcher.

4. Long-Range Missiles: The Ghost Wasp can be reconfigured as a long-range bomber by mounting two heavy missile launchers on the sides near the back. In this configuration, it cannot use the flechette rifle (the magazine would get in the way), although the pilot usually carries a regular rifle, either a TB-Prime or an FR-5, but the ammo is limited to what can be carried. The missiles are used against heavy vehicles (like the Galapagos robot), or against fixed targets such as cities and bunkers.

Primary Purpose: Anti-armor, bombardment.

Secondary Purpose: Defense.

Mega-Damage: Varies with missile type.

Rate of Fire: One at a time, or volleys of two or four missiles.

Effective Range: 500 to 1200 miles (800 km to 1930 km).

Payload: Four total; two per launcher.

5. Stealth System: The Ghost Wasp uses a holographic chameleon system, similar to the one used by the Spectral Hunter cyborgs, but much more advanced. While the cyborgs can change the color of their shell armor to match the surroundings, the Ghost Wasp can actually project a hologram that completely matches the surrounding area, down to leaves, cloud formations, and star patterns. People trying to spot them are at -50% to detect ambush and on detect concealment rolls (-20% if the Wasp is moving). The stealth system also masks infrared and thermal emissions, making the wearer's heat invisible to infrared and thermal optics. There is only a 21% chance of showing up on thermal systems and even then the reading/image will seem unusual. All this only works if the Wasp is moving at speeds under 100 mph (160 kmph) and is not using its weapon systems. The moment it does either, the holographic system becomes useless and shuts off.

6. Hand to Hand Combat: Rather than use a weapon, the pilot can engage in mega-damage hand to hand combat.

Power Armor Bonuses:

+1 attack per melee at levels one, six, and twelve; in addition to those of the pilot.

+1 to dodge at levels three, seven and eleven.

+1 to roll with punch, fall or impact.

Critical strike, same as the pilot's.

Mega-Damage:

Restrained punch inflicts 1D4 M.D.

Full Strength Punch — 1D6 M.D.

Power Punch — 3D4 M.D. but counts as two attacks.

Kick — 2D4 M.D.

Leap Kick — 3D6 M.D. but counts as two melee attacks.

Flying Body Block/Ram or Wing Swipe — 1D6x10+10 M.D., but both wings on that side take 3D6 M.D. from the impact.

Tail Strike — 1D6 M.D.

Death Cyclops Assault Suit

The Death Cyclops is the standard assault suit of the Arkhon Armored Cavalry, designed to keep up with tanks, and to have the firepower to act like tanks, if necessary. Its general shape is inspired by a humanoid predator native to the Arkhon homeworld; like the real death cyclops, this suit inspires fear, and is quite capable of slaughtering victims wholesale. Thousands of these suits are in service among the Arkhons on Earth and in space, where they have earned a reputation as demonic death bringers.

This suit of powered armor has broad armored shoulders, oversized arms, and comparatively slender legs. The tail of the Arkhon pilot can be tucked inside the armored torso for greater protection. The head has a central visual sensor; a similar cyclopean eye symbol decorates the chest plate. There are no visible weapon systems on the suit, but four small tri-beam guns are hidden in the chest and neck area. The Death Cyclops is often issued a flechette machinegun or a tri-beam M-100 in a rifle configuration. They can also be outfitted with a number of attack modules. These modules are fitted to the back of the suit, and can include a variety of missiles, mortar rounds, or anti-aircraft weapons.

The Death Cyclops excels at assault missions. The suit's advanced artificial muscles make it one of the strongest power armors of their size and weight. The spikes on its forearms are ultra-strong and surrounded by vibro-fields that do great damage to most M.D.C. alloys. Only the supernatural-powered armor suits used by the Inca have proven to be superior in hand to hand combat. This superiority meant the deaths of hundreds of over-eager Death Cyclops pilots who rushed to come to grips with their “primitive” opponents.

Even when faced with the more physically powerful magic armor of the Incas, however, the Death Cyclops have proved themselves in battle. For one, the Arkhons can produce more of the technological suits, and they can overwhelm the more powerful Inca models by sheer weight of numbers. Additionally, the Arkhons have changed tactics, and now engage the armored Incas at a distance, wearing them down with missile weapons, and saving their lethal charges when facing infantrymen or the less capable Atahualpa power armor.

Death Cyclops typically operate in fireteams of 3-5 soldiers. At least one of these will have a mortar or missile launcher, giving the squad the ability to engage the enemy at any range up to a mile (1.6 km) away. They also rarely operate too far away from larger formations. When encountering a team of Death Cyclops, adventurers should remember that enemy reinforcements can be as little as five minutes away!

Model Type: APA-9

Class: Heavy Assault Infantry Exoskeleton

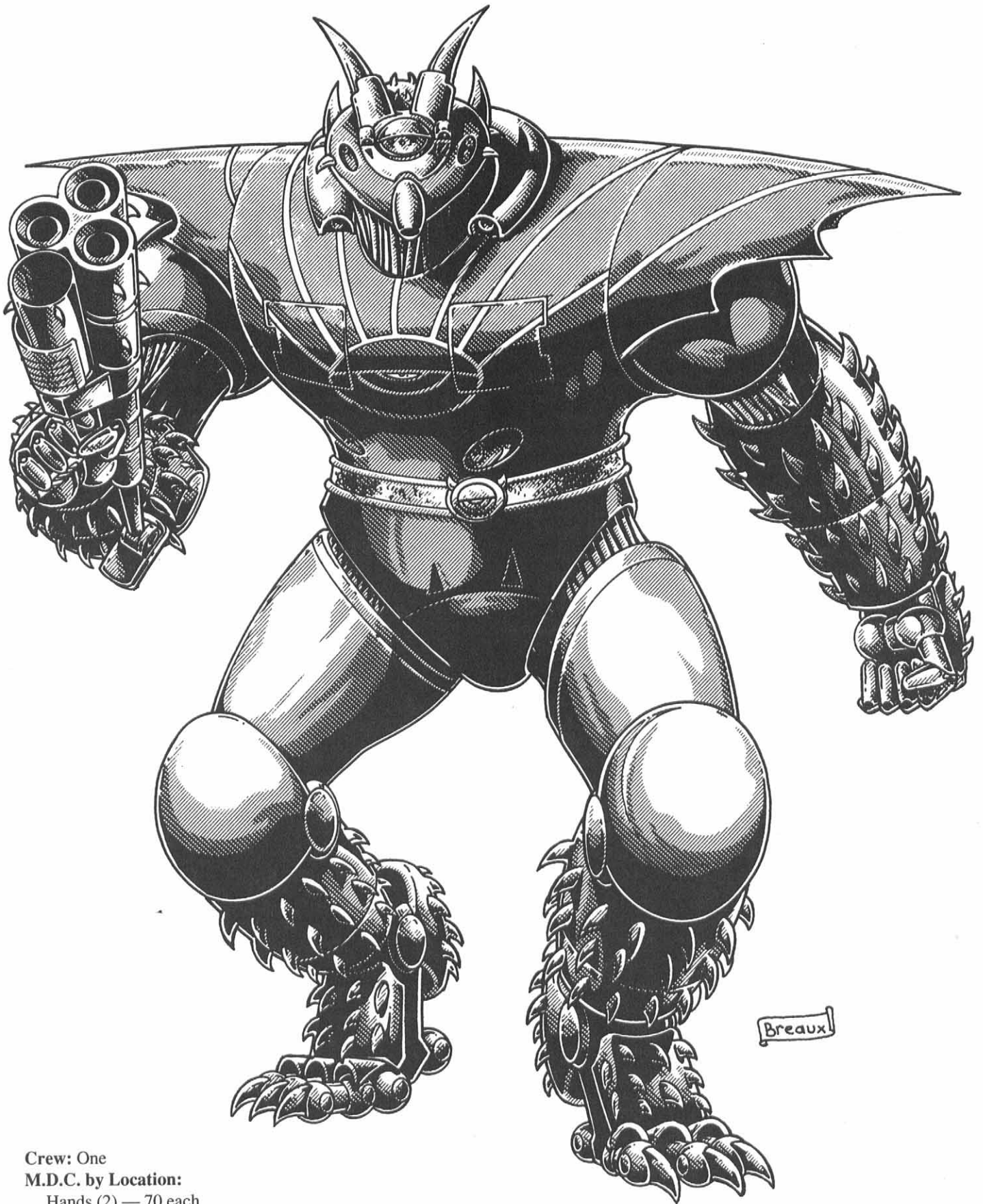

Crew: One

M.D.C. by Location:

- Hands (2) — 70 each
- Arms (2) — 160 each
- Legs (2) — 230 each
- Assault Rifle — 150
- * Head — 180
- ** Main Body — 450

* Destroying the head of the power armor will eliminate all forms of optical enhancement and sensory systems. The pilot is forced to rely on his own vision and senses. Furthermore, all power armor combat bonuses to strike, parry and

dodge are lost! Note: The head is a small and difficult target to hit; requires a called shot, at -4 to strike.

** Depleting the M.D.C. of the main body destroys the power armor, making it useless.

Remember, energy weapons do half damage, but kinetic weapons (bullets, M.D. fists, magic arrows, direct hits from missiles, etc.) do double damage.

Speed

Running: 80 mph (128 kmph) maximum. Note that the act of running does tire out the operator, but at 10% the normal rate thanks to the robot exoskeleton.

Flying: Not possible.

Statistical Data:

Height: 9 feet (2.7 m)

Width: 6 feet (1.8 m)

Length: 4 feet (1.2 m)

Weight: 1 ton

Physical Strength: Equal to a P.S. 45.

Cargo: None

Power System: Anti-matter; average energy life is 25 years.

Market Cost: Not for sale. Captured or stolen suits may be found in the South American Black Market but are extremely rare, and would cost from 11 million for a new, undamaged suit (almost unheard of) to 5 million for a partially rebuilt suit (permanently reduce M.D.C. by 25%, tri-beam system replaced by lasers inflicting 1D6 to 4D6 M.D., shoulder weapon replaced with rail gun or similar large energy weapon).

Weapon Systems

1. Assault Rifle: There are two possible configurations for the shoulder weapon of the Death Cyclops. The first one is an oversized flechette gun, essentially identical to the FRA-1 auto-cannon. The second one is a rifle version of the M-100 tri-beam gun. The typical five-man squad breakdown is two soldiers with flechette guns and three with tri-beams.

Primary Purpose: Anti-armor, anti-personnel.

Secondary Purpose: Defense.

Mega-Damage: Flechette Rifle: 1D4×10 M.D. per shot. A burst is 10 rounds and does 2D6×10+10 M.D. The burst can be used to spray an area, doing one shot damage to affected targets.

Tri-Beam Rifle: A single shot inflicts 5D6 M.D.; a 3-round burst does 1D4×10+10 M.D., double damage to most materials, except force/energy fields and Arkhon composite armor.

Rate of Fire: Standard.

Effective Range: Flechette Gun: 4000 feet (1220 m); Tri-Beam: 3000 feet (914 m).

Payload: 100 round magazine for the Flechette Gun (10 bursts); unlimited for the tri-beam. Two additional magazines for the flechette gun can be placed on clamps on the back.

2. Torso Tri-Beams (4): Four light tri-beams, each roughly equivalent to a TB pistol, are located in strategic spots in the torso and can be activated by the pilot with a gesture. The beams can engage separate targets or can be made to fire simultaneously at the same target.

Primary Purpose: Anti-personnel.

Secondary Purpose: Defense.

Mega-Damage: Each beam does 2D4+2 M.D., double damage to most materials, except force/energy fields and Arkhon composite armor. A double beam does 4D4+4 M.D., and a simultaneous quadruple beam attack inflicts 1D4×10 M.D. (counts as one melee attack)

Rate of Fire: Equal to the combined number of hand to hand attacks of the pilot.

Effective Range: 500 feet (152 m)

Payload: Effectively unlimited.

3. Mini-Missile Module: This is a common module used for a variety of missions, from assault to short-range bombardment. The launcher is a box of 24 mini-missiles that can be emptied in two volleys.

Primary Purpose: Assault, anti-personnel

Secondary Purpose: Defense, anti-aircraft.

Mega-Damage: Varies with missile type.

Rate of Fire: One at a time, or in volleys of two, four, six, eight, ten or twelve mini-missiles.

Effective Range: About one mile (1.6 km)

Payload: 24 mini-missiles.

4. Anti-Aircraft Module 1 (optional): This module can be used in place of the mini-missile module. It includes an advanced radar array (increases radar range to 100 miles/160 km and can identify and track up to 48 different targets) tied to a flak cannon and six medium-range missiles. This module is large and heavy; reduce maximum speed of the power armor by 30%.

Primary Purpose: Anti-aircraft

Secondary Purpose: Defense

Mega-Damage: Flak Cannon: Each explosive shell has a proximity fuse, and explodes in mid-air, inflicting 1D4×10 M.D. to a 60 feet (18.3 m) area.

Medium-Range Missiles: Varies with missile type.

Rate of Fire: The cannon can fire single shots only. The missiles can be fired one at a time, or in volleys of two, four, or six missiles.

Effective Range: Flak Cannon: 1 mile (1.6 km). Missiles: 40 to 80 miles (64 to 128 km)

Payload: 60 flak rounds and six medium-range missiles.

5. Anti-Aircraft Module 2 (optional): This system is designed to locate and engage targets over a hundred miles away, and relies on a larger radar array (range is increased to 200 miles/320 km, but only if the power armor is in the plains) and 3 long-range missiles. The usefulness of this system is limited in the mountains that are the main battlefields of the current conflict, but some of these modules have been used against Cordoba.

Primary Purpose: Anti-aircraft

Secondary Purpose: Bombardment

Mega-Damage: Varies with missile type.

Rate of Fire: One at a time, or in volleys of two or three missiles.

Effective Range: Varies with missile type.

Payload: Three missiles.

6. Mortar Module (optional): This module is almost identical to the BM-2 backpack mortar, but it has greater ammo capacity. A squad of power armor troopers equipped with these modules can saturate a large area with bomblets, instantly killing anybody not wearing M.D.C. armor.

Primary Purpose: Bombardment

Secondary Purpose: Anti-armor

Mega-Damage: Dual-purpose mortar round. The shooter can electronically "prime" the rounds before firing them, selecting either fragmentary or anti-armor. In the first mode, the bomblet detonates in the air, 8 feet (2.4 m) before hitting the ground, and showers the area with lethal fragments. In the second mode, the

bomb explodes on impact, with minimal blast radius but maximum damage to the target.

Fragmentary: 3D6 M.D. to a 20 foot (6.1 m) radius.

Anti-Armor: 6D6 M.D. to a 2 foot (0.6 m) radius.

Rate of Fire: Single shot, burst of 3, or long burst of 6. Each counts as one melee attack.

Effective Range: Up to 2 miles (3.2 km).

Minimum Range: 300 feet (90 m)

Payload: 120 bomblets in the magazine.

7. Hand to Hand Combat: Rather than use a weapon, the pilot can engage in mega-damage hand to hand combat.

Power Armor Bonuses:

+1 attack per melee at levels one, six, and twelve; in addition to those of the pilot.

+1 to dodge at levels one, four, eight and twelve.

+2 to roll with punch, fall or impact.

+1 to pull punch.

Critical strike, same as the pilot's.

Mega-Damage:

Restrained Punch: 1D6 M.D.

Full Strength Punch or Kick: 3D6 M.D.

Power Punch: 1D4×10 M.D. (counts as two melee attacks)

Punch with Vibro-Field activated: 6D6 M.D.

Great Cyclops Assault Robot

This robot is a gigantic version of the Death Cyclops power armor. Not only is the armor almost three times as big, it stands on two stilts that allow it to plant itself into the ground, making it very difficult to dislodge. The robot can also fly, making it one of the largest flying vehicles of its class. Unlike the Death Cyclops, this robot does not carry any rifles or hand weapons. Instead, it has a number of built-in attack systems that make it the match of any tank or robot on the planet. The hands conceal heavy tri-beam cannons, a flechette machinegun is built into the chin area, the knees hide two batteries of mini-missiles, and the chest plates can be flipped outward to unmask a medium-range missile battery. The lower torso has two lighter tri-beams, and the head has two smoke dispensers on the sides and a powerful searchlight on the central "eye." Vibro-spikes on the forearms increase the damage from hand to hand attacks to almost supernatural levels. Massively armored with over 10 inches of Cerasteel in some places, the robot can sustain enormous punishment before being destroyed. Since the weapon systems are built into the body, they cannot be easily targeted and thus can only be silenced by destroying the robot itself.

The Great Cyclops uses only one pilot and no additional gunners. The "organic" arrangement of the weapons makes piloting this robot something more akin to wearing power armor than driving a vehicle, and early tests during the development of the Great Cyclops showed that multiple gunners only got in each other's way. Even with only one pilot, the robot moves and fights with incredible speed.

A typical Arkhon attack formation consists of 1-3 Great Cyclops supported by 5-10 Stormwind or 3-5 Death Cyclops power armor troopers. This highly mobile force is usually sent to capture or destroy bridges, key road junctions, and other strategic targets. When fighting the Empire of the Sun, these formations

will often slaughter whole companies of infantrymen; the only way to stop them is to use the best rune warriors, demigods, godlings, their own advanced power armor and/or Nazca line magic.

Model Type: AB-17

Class: Strategic Air-Land Assault Robot

Crew: One. The pilot's compartment can seat an additional three passengers.

M.D.C. by Location:

Hands (2) — 125 each

Arms (2) — 350 each

Legs (2) — 370 each

** Head — 350

Knee Plates/Mini-Missile Launchers — 150 each

* Searchlight — 20

*** Main Body — 750

Reinforced Pilot's Compartment — 200

* The searchlight is a tiny target. It can only be hit on a called shot, at -5 to strike. The same is true of the concealed weapon systems.

** Depleting the M.D.C. of the head has no effect other than destroying the weapon systems and searchlights built into it. Sensor arrays are spread around the torso area, and are only destroyed when the robot is destroyed.

*** Depleting the M.D.C. of the main body destroys the robot.

Remember, energy weapons do half damage, but kinetic weapons (bullets, M.D. fists, magic arrows, direct hits from missiles, etc.) do double damage.

Speed

Running: 100 mph (160 kmph) maximum. Note that the act of running does not tire out the pilot.

Flying: 400 mph (640 kmph) maximum speed. Cruising speed is typically a lower 100 to 200 mph (160 to 320 kmph). The anti-gravity system allows the wearer to make very tight turns, stop on a dime, and other aerial acrobatic feats. Furthermore, there is NO limit to the altitude the suit can achieve. It can even escape Earth's atmosphere and reach outer space.

Range: Theoretically unlimited. However, the propulsion system overheats and must be allowed to cool off after flying 6 hours at over 200 mph (320 kmph), or after flying 12 hours at cruising speed.

Statistical Data

Height: 35 feet (10.5 m)

Width: 16 feet (4.8 m)

Length: 8 feet (2.4 m)

Weight: 35 tons

Physical Strength: Equal to a P.S. 55

Cargo: Small locker with room for a pistol or sub-machinegun and personal effects.

Power System: Antimatter; average energy life 25 years.

Market Cost: Not for sale, and there has never been a stolen or rebuilt robot to ever reach market (pilots either fight to the death or set the self-destruct mechanism before they surrender. If the bot was ever made available, it would cost 50+ million credits!

Weapon Systems

1. Hand Tri-Beam Cannons (2): A tri-beam cannon is built into each forearm and back of the robot's hands. These "fist beams" can fire single blasts or combine them for a devastating double blast (counts as two hand to hand attacks per melee). **Note:** If the hands are destroyed, so are these cannons.

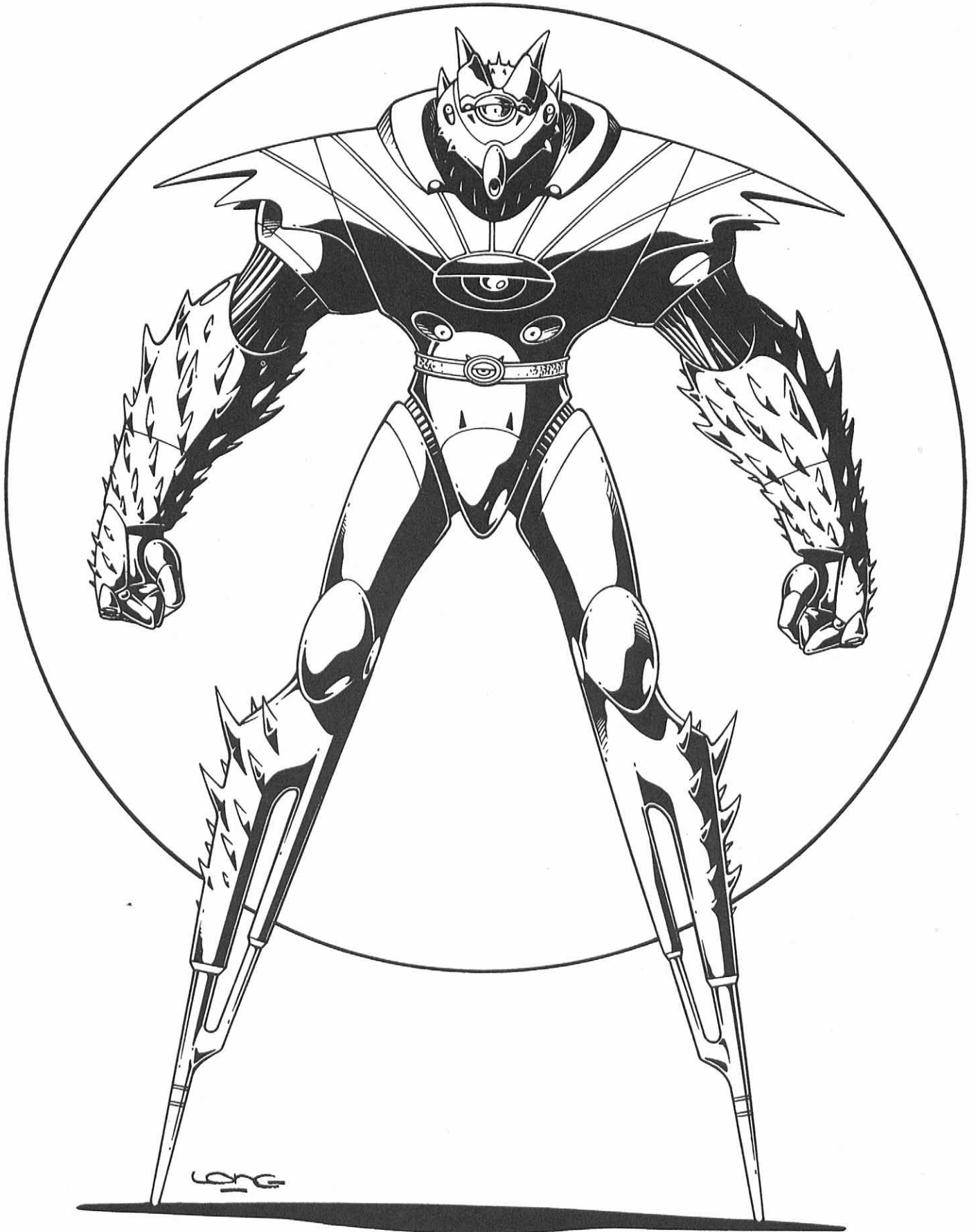

Primary Purpose: Anti-armor

Secondary Purpose: Defense

Mega-Damage: 2D4x10 M.D. per single blast, or 4D4x10 M.D.

per simultaneous double blast (counts as two hand to hand attacks), double damage to most materials, except force/energy fields and Arkhon composite armor.

Rate of Fire: Equal to the number of hand to hand attacks of the pilot.

Effective Range: 4000 feet (1220 m)

Payload: Effectively unlimited.

2. Torso Missile Launchers (5): The converging pattern extending from the eye design on the chest conceals movable plates. When the plates swing outward, *five medium-range missile launchers* are revealed, each with a payload of four missiles. **Note:** Each of the five launchers has 30 M.D.C. but are vulnerable to attack only when they are preparing to fire, requiring a "called strike" to be made and even then are -2 to hit!

Primary Purpose: Anti-armor and anti-aircraft.

Secondary Purpose: Defense

Mega-Damage: Varies with missile type.

Rate of Fire: One at a time, or in volleys of 2, 4, 8, 16 or 20 missiles!

Effective Range: 40 to 80 miles (64 to 128 km).

Payload: 20 missiles total; four per launcher.

3. Flechette Machinegun (1, in head): The central tube beneath the chin is actually a flechette machinegun, a heavy version of the FRA-1. The gun is used to engage nearby targets, including infantrymen.

Primary Purpose: Anti-personnel

Secondary Purpose: Defense

Mega-Damage: 1D4×10 M.D. per shot. A burst is 10 rounds and does 2D6×10+10 M.D. The burst can be used to spray an area, doing one shot damage to affected targets.

Rate of Fire: Standard.

Effective Range: 4000 feet (1220 m)

Payload: 2000 rounds.

4. Tri-Beam Guns (2): Two tri-beam guns are built into the lower torso, and are used to fire upon "small" vehicles, power armor and foot soldiers.

Primary Purpose: Anti-armor.

Secondary Purpose: Defense.

Mega-Damage: 3D6 M.D. per beam, or simultaneous double blast does 6D6 M.D., double damage to most materials, except force/energy fields and Arkhon composite armor.

Rate of Fire: Equal to the number of combined hand to hand attacks of the pilot.

Effective Range: 2000-feet (610 m)

Payload: Effectively unlimited.

5. Mini-Missile Launchers (2): The knee guards conceal two mini-missile launchers. Two reloads per launcher are stored in the upper leg area. Once a launcher has emptied its missiles, the storage area cycles a new load in.

Primary Purpose: Anti-armor, anti-personnel, anti-aircraft.

Secondary Purpose: Defense.

Mega-Damage: Varies with missile type.

Rate of Fire: One at a time, or in volleys of 2, 4, 6, 8 or 16 missiles. Once all 8 mini-missiles have been fired from a launcher, it takes one melee round for the reloads to cycle from the storage compartment.

Effective Range: About one mile (1.6 km).

Payload: 48 total, 8 missiles and two reloads in each leg.

6. Smoke Dispensers (2): Two compartments on the sides of the head are smoke dispensers that release a thick, impenetrable cloud. The Arkhon favor a thick, heavier than air mixture that settles downward, blinding infantrymen and ground vehicles

while the Great Cyclops towers over the fog and dominates the battlefield. The gas is designed to interfere with infrared and thermal sights (-30% to sensor rolls) as well as normal sight.

7. Searchlight (1): A multi-optic searchlight is built into the central "eye" in the head. The lenses can produce normal light, ultra-violet, and infra-red illumination.

8. Hand to Hand Combat: Rather than use a weapon, the pilot can engage in mega-damage hand to hand combat.

Robot Bonuses:

+1 attack per melee at levels one, five and ten; in addition to those of the pilot.

+1 to dodge at levels one and eight.

+2 to roll with punch, fall or impact.

Critical strike, same as the pilot's.

Mega-Damage:

Restrained Punch: 2D6 M.D.

Full Strength Punch: 6D6 M.D.

Power Punch: 2D6×10 M.D. (counts as two attacks)

Punch with Vibro-Spikes Activated: 1D6×10 M.D.

Other Vehicles

"Porcupine"

T-10 Assault Tank

The T-10 Porcupine is built along the same lines as all other Arkhon Vehicles, with a stylized "Eye" in the front of the vehicle (under the main turret). The spine-like protrusions that cover some of the tank are only part of the reason for the T-10's nickname, the other is the number of guns that protrude from it. The Porcupine has one main turret with two over-and-under cannons; each double cannon consists of a tri-beam weapon over a rifled piece that fires conventional explosive shells. Additionally, two small side turrets bristle with smaller tri-beam weapons, and a box mini-missile launcher has its own turret in back. A cupola on top of the turret has an automatic flechette gun, used to knock down enemy missiles. Furthermore, the bow of the tank sports two additional flechette guns on front-placed mini-turrets. The T-10 uses a hovercraft system, allowing it to maneuver even in the broken mountain terrain.

T-10s are used mainly during major engagements in the war against the Inca. Tanks are too vulnerable in mountain warfare to use them extensively. The tanks can operate more efficiently in the jungles and the plains, and in those areas, small platoons of 1-3 tanks (typically supported by 1-2 APCs or 3-10 Stormwind troopers) can be seen in action.

Model Type: T-10

Class: Main Battle Tank

Crew: Six; four gunners, a driver and a commander.

M.D.C. by Location:

** Main Turret — 450

Over-and-Under Cannons (2, on turret) — 170 each

Flechette Gun Cupola (on top of turret) — 120

Tri-beam Mini-turrets (2, on sides) — 130 each

Front Flechette Gun Mini-turrets (2, up front) — 120 each

Mini-Missile Battery (1, behind main turret) — 100

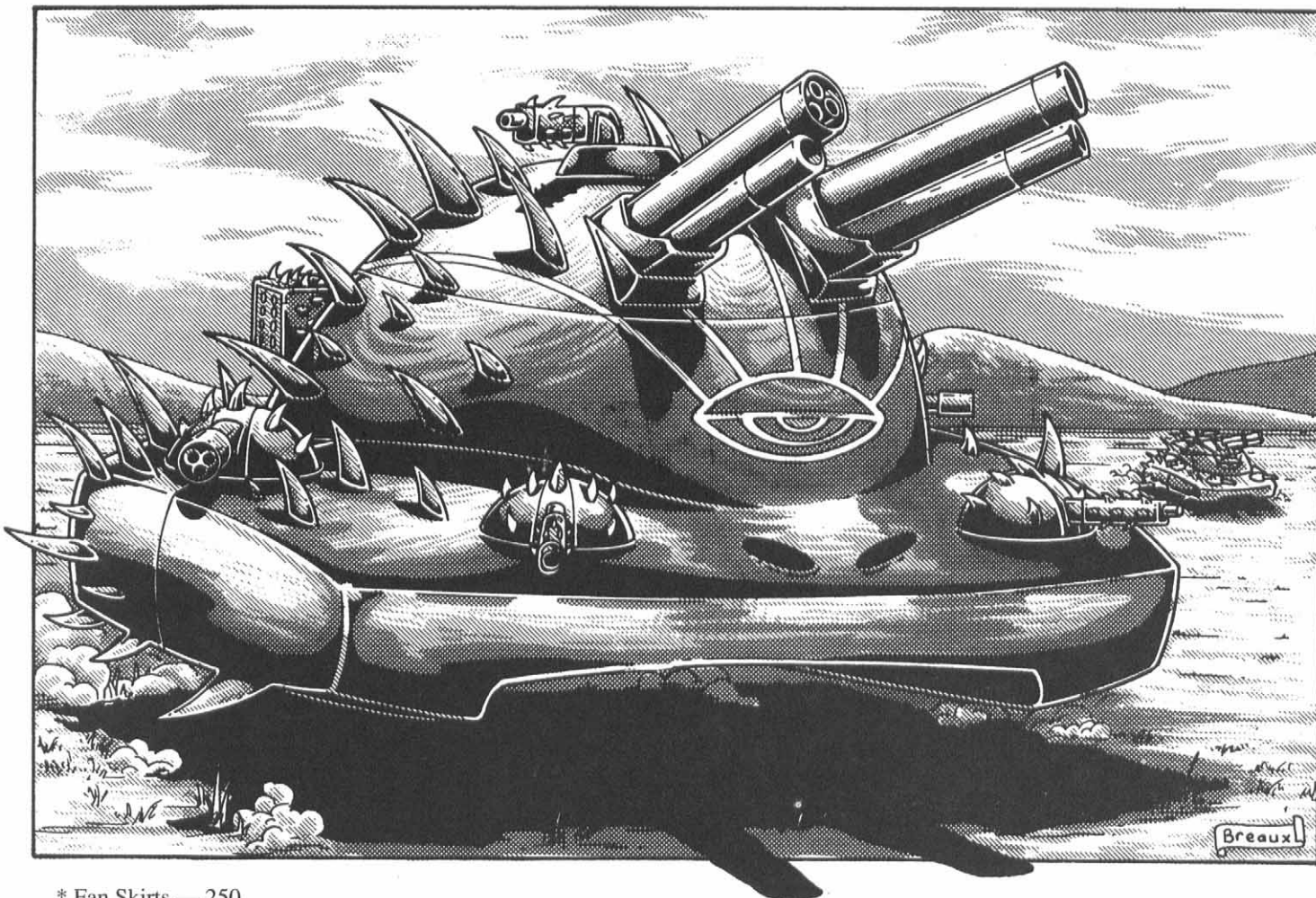

* Fan Skirts — 250

*** Main Body — 600

Reinforced pilot's compartment — 150

* Destroying the fan skirts will destroy the hovercraft system, grounding the vehicle and rendering it immobile. Field repairs will take 1D6 hours (and there is a 1-40% chance the tank cannot be repaired in the field).

** Depleting the M.D.C. of the turret tears it off the vehicle, rendering all weapons in it useless. Targeting the turret requires a called shot at no further penalty.

*** Depleting the M.D.C. of the main body destroys the vehicle, rendering it useless.

Speed

Driving on the ground: 200 mph (320 kmph) maximum.

Flying: Not possible. The hover system cannot lift the tank more than five feet (1.5 m) off any surface without losing pressure and sinking back down. The tank can cross water (but only for short distances) and is unaffected by broken terrain.

Statistical Data

Height: 12 feet (3.65 m)

Width: 13 feet (3.9 m)

Length: 20 feet (6.1 m)

Weight: 70 tons fully loaded.

Cargo: Small 3 foot (0.9) locker compartment for personal effects, plus a weapons locker with six energy rifles, six energy pistols, 24 E-Clips and 16 grenades.

Power System: Antimatter; average energy life is 25 years.

Market Cost: Not for sale. There is a 3% chance a captured tank can be found in the black market on any given month; such a

tank would have 1D4×10% less M.D.C., would be missing 1D4 weapon systems, and would cost 10-20 million credits.

Weapon Systems

1. Double Cannons (2 sets): The two double cannons provide the Porcupine with a total of four main guns. The guns must fire independently; no double or quadruple blasts may be attempted. The gunners that man each cannon can fire as often as four times per melee each (if they have enough hand to hand attacks/actions). The conventional cannon on the underside fires a variety of ammunition, from plasma to armor-piercing warheads.

Primary Purpose: Anti-armor

Secondary Purpose: Anti-personnel

Mega-Damage: Tri-Beam Cannon: 2D4×10 M.D., double damage to most materials, except force/energy fields and Arkhon composite armor. Conventional Cannon: Varies with ammunition. Available rounds include High Explosive (2D6×10 M.D. to a 30 foot/9.1 m area), Plasma (2D6×10 to a 20 foot/6.1 m area), and Armor Piercing Discarding Sabot (3D4×10+10 M.D., no blast area).

Rate of Fire: Each of the over-and-under guns can fire twice per melee round, for a total of four attacks. With two gunners, the tank's main guns can fire as often as eight times per melee round!

Effective Range: Tri-Beam Cannon: 4000 feet (1220 m). Conventional Cannon: 10,000 feet (3,050 m).

Payload: Unlimited for the tri-beam; 30 shots per conventional cannon (60 total). The gunner can "dial" for a specific type of round, as long as it is still in the magazine.

2. Flechette Gun Cupola: This is an automated weapon system, that fires at +2 to strike. Its main purpose is to destroy incoming missiles before they can hit the tank.

Primary Purpose: Defense

Secondary Purpose: Anti-personnel

Mega-Damage: A burst is three rounds and does 1D4×10+10 M.D.; can only fire bursts.

Rate of Fire: The automated system is at +2 to strike and has 5 attacks per melee.

Effective Range: 3000 feet (914 m)

Payload: 600 rounds.

3. Tri-beam mini-turrets (2): These side turrets are operated by the second and third gunners, and are used to engage targets threatening the flanks or rear of the tank.

Primary Purpose: Anti-armor

Secondary Purpose: Defense

Mega-Damage: Each pulsed blast inflicts 1D4×10+10 M.D., double damage to most materials, except force/energy fields and Arkhon composite armor.

Rate of Fire: Equal to the number of hand to hand attacks of the gunner.

Effective Range: 3000 feet (914 m)

Payload: Effectively unlimited.

4. Flechette Gun Mini-Turrets (2): These two turrets are in front of the turrets, and are operated by the same gunners in charge of the side tri-beam turrets. The gunners cannot use both weapons at once, however. Typically, the gunners switch to the flechette turrets when the enemy forces are in the rear. Alternatively, the tank commander and/or the pilot can also take control of the weapons.

Primary Purpose: Anti-armor and anti-personnel.

Secondary Purpose: Defense

Mega-Damage: A burst is three rounds and does 1D4×10+10 M.D. Can only fire bursts.

Rate of Fire: The automated system is at +2 to strike and has five attacks per melee.

Effective Range: 3000 feet (914 m)

Payload: 600 rounds.

5. Mini-Missile Turret: A box-shaped mini-missile launcher is located in the back.

Primary Purpose: Anti-aircraft and anti-personnel.

Secondary Purpose: Defense.

Mega-Damage: Varies with missile type.

Rate of Fire: One at a time, or in volleys of two, four, eight or ten missiles.

Effective Range: About one mile (1.6 km).

Payload: Twenty mini-missiles.

“Evil Eye” APC

The “Evil Eye” has taken the Cyclops design one step further, making the eye into an energy weapon! This troop carrier/fighting vehicle has no turret; its boxy design is slightly reminiscent of the 20th Century M-113 troop carrier, except that it floats on an air cushion instead of tracks, and the front is slightly curved.

The “Eye” is a short-range particle-beam irradiator; the weapon bathes the area in front of it with an intense burst of charged particles that melts or disintegrates almost everything in front of it. This “clears” the immediate area, allowing troops to dismount in safety. Other weapons include a pintle-mounted tri-

beam machinegun (the gunner must open a hatch and expose himself to enemy fire to use it) and two side-mounted missile launchers. Firing slits on the sides allow the troops to shoot from both sides.

Model Type: A-73

Class: Armored Personnel Carrier.

Crew: Three; a pilot and two gunners.

Troop Capacity: 12 soldiers in combat armor, or 8 in power armor.

M.D.C. by Location:

Tri-Beam Gun (on top) — 60

Side-Mounted Missile Launchers (2) — 80 each

* Fan Skirts — 120

** Main Body — 400

* Destroying the fan skirts will destroy the hovercraft system, grounding the vehicle and rendering it immobile. Field repairs will take 1D6 hours (and there is a 1-40% chance the tank cannot be repaired in the field).

** Depleting the M.D.C. of the main body destroys the vehicle, rendering it useless.

Speed

Driving on the ground: 200 mph (320 kmph) maximum.

Flying: Not possible. The hover system will not lift the vehicle beyond 5 feet (1.5 m) off the surface.

Statistical Data

Height: 11 feet (3.3 m)

Width: 9 feet (2.7 m)

Length: 15 feet (4.5 m)

Weight: 15 tons fully loaded.

Cargo: Troop compartment holds 12 troops with their equipment. 5 tons of cargo can be substituted.

Power System: Anti-matter; average energy life of 25 years.

Market Cost: Not for sale.

Weapon Systems

1. “Evil Eye” Particle Beam Irradiator: This wide-beam weapon is installed in the front, and is part of the Arkhon eye design. The beam is actually a burst of short-lived but highly intense radiation that not only destroys matter like conventional particle beam weapons, but also heats armor and metals to the point that even soldiers in full body armor will take some damage as they are baked inside their armor!

Primary Purpose: Anti-personnel

Secondary Purpose: Defense

Mega-Damage: 4D6 M.D. to a 30 foot (9.1 m) radius in front of the tank. Additionally, humans and S.D.C. humanoids protected by body armor will still take 3D6 S.D.C. damage from the residual heat seeping through the armor! Power armor, robots and larger vehicles are better insulated; their crews get a save vs lethal poison (14 or higher) to avoid the effects of the heat.

Rate of Fire: Each pulse counts as two melee attacks/actions (the pilot must hold the trigger down for 4-6 seconds) and it can only be used three times per melee maximum.

Effective Range: 200 feet (61 m).

Payload: Effectively unlimited.

2. Pintle-mounted Tri-Beam: The gunner must leave the safety of the vehicle and is exposed to enemy fire (hitting the gunner requires a called shot at -2 due to the gun shield protecting the gunner).

Primary Purpose: Anti-armor

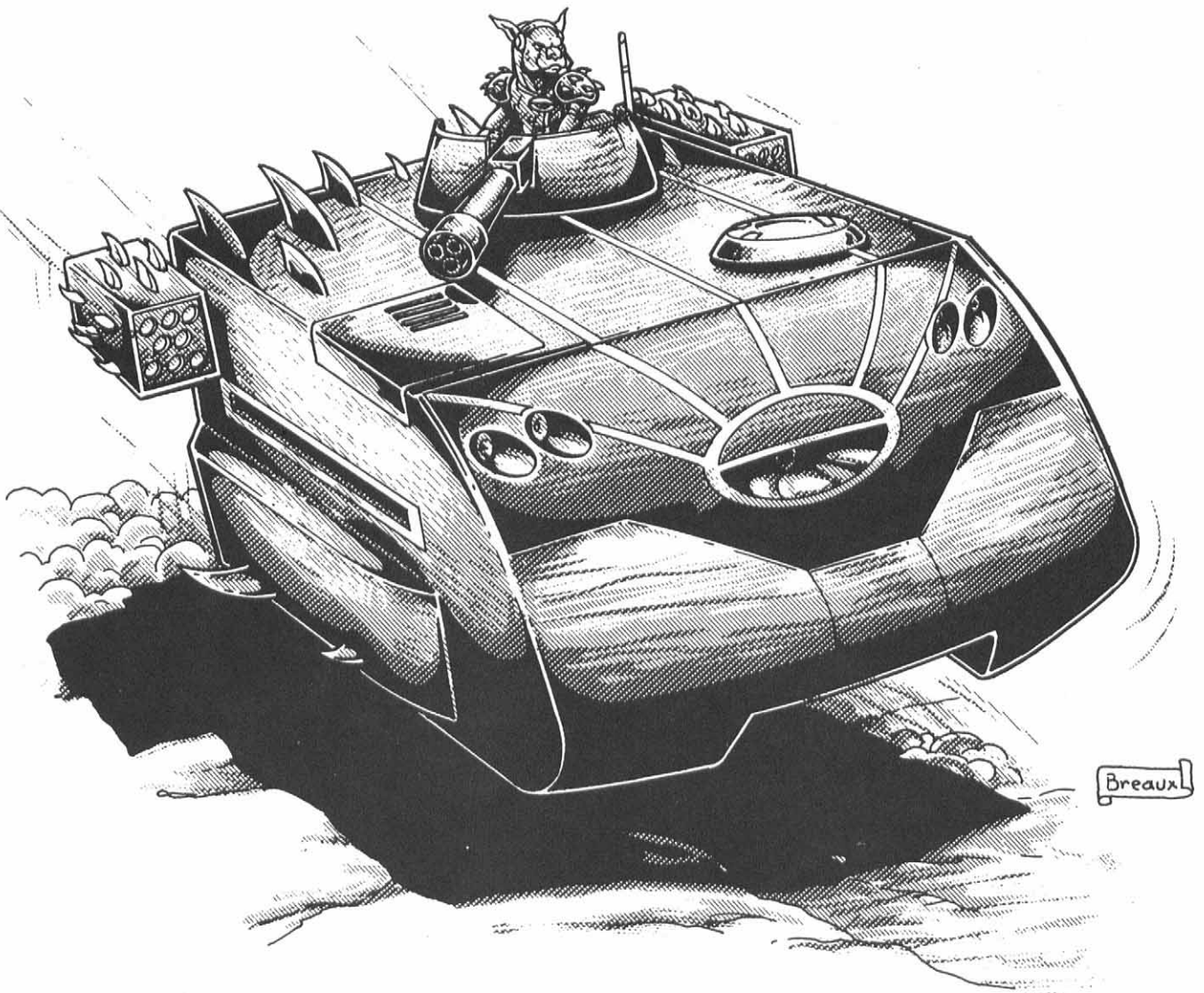

Secondary Purpose: Defense

Mega-Damage: Each pulse blast inflicts 1D4×10+10 M.D., double damage to most materials, except force/energy fields and Arkhon composite armor.

Rate of Fire: Equal to the number of hand to hand attacks of the gunner.

Effective Range: 3000 feet (914 m)

Payload: Effectively unlimited.

3. Mini-Missile Launchers (2): A launcher on each the side provides the APC's main long-distance striking power.

Primary Purpose: Anti-aircraft and anti-armor.

Secondary Purpose: Defense

Mega-Damage: Varies by missile type.

Rate of Fire: One at a time, or volleys of two, four, eight or sixteen missiles.

Effective Range: About one mile (1.6 km).

Payload: 16 total, eight per launcher.

Spikefish Attack Fighter

The Spikefish is the main attack fighter in the Arkhons' arsenal. This ugly vessel can fly both in space and the atmosphere, and can be configured for a variety of missiles, for intercepting enemy fliers to strafing infantry and bombing cities or military targets. The people of the Empire of the Sun have learned to

dread the howling sound of these fighters when they make a bombing dive. The common Spikefish attack load consists of 2-4 long-range missiles and 4-8 medium-range missiles. Additionally, the fighter has four tri-beam guns. Attack wings of these fighters work side by side with flying power armor troopers using the Stormwind and Ghost Wasp armor.

Model Type: AF-89

Class: Attack Fighter (Air/Space Capable)

Crew: One.

M.D.C. by Location:

Tri-Beam Double guns (2, on sides) — 100 each

Missile Pylons — As per the missiles carried (see *Rifts RPG*, p. 46).

* Main Body — 300

Reinforced Pilot's Compartment/Escape Pod— 120

* Depleting the M.D.C. of the main body causes the aircraft to crash. The pilot can eject in the escape pod, designed to either parachute to safety in an atmosphere, or float in space. The pod is airtight and has enough life support for 20 hours.

Speed

Driving on the ground: Not possible.

Flying: Mach 2 in an atmosphere, Mach 8 in space. The anti-gravity system allows the pilot to make very tight turns, stop on a dime, and other aerial acrobatic feats. Furthermore, there is

NO limit to the altitude the fighter can achieve. It can even escape Earth's atmosphere and reachouterspace.

Range: In an atmosphere, the propulsion system must be allowed to cool off after 12 hours of flight.

Statistical Data

Height: 6 feet (1.8 m); the landing wheels, when extended, add an additional 2 feet (0.6 m).

Width: 12 feet (3.65 m) from tip to tip.

Length: 8 feet (2.4 m)

Weight: 1 ton fully loaded.

Cargo: None. Pilot has room for a sidearm and little more.

Power System: Anti-matter; average energy life of 20 years.

Market Cost: Not for sale. No Spikefish has been captured in any shape to be resold.

Weapon Systems

1. Double Tri-Beam Cannons (2): These side-mounted guns are the main dogfight and strafing weapons of the Spikefish. Each double cannon fires devastating double blasts, but the two double guns are not aligned to fire at the same target simultaneously.

Primary Purpose: Anti-armor and anti-aircraft.

Secondary Purpose: Anti-personnel

Mega-Damage: Each double blast inflicts 2D4×10 M.D., doubled against most materials except force fields and Cerasteel armor.

Rate of Fire: Equal to the combined number of hand to hand attacks of the pilot.

Effective Range: 4000 feet (1220 m)

Payload: Effectively unlimited.

2. Missile Pylons: Up to eight medium-range missiles or four long-range missiles, or any combination thereof, can be carried in the underside of the fighter.

Primary Purpose: Bombardment

Secondary Purpose: Anti-aircraft

Mega-Damage: Varies with missile type.

Rate of Fire: One at a time, or volleys of 2, 4, or 8.

Effective Range: Varies with missile (can fire long- or medium-range missiles)

Payload: Up to eight medium range missiles, four long-range missiles, or a combination thereof (i.e., two long-range and four medium-range missiles, or one long-range and six medium-range missiles, and so on.)

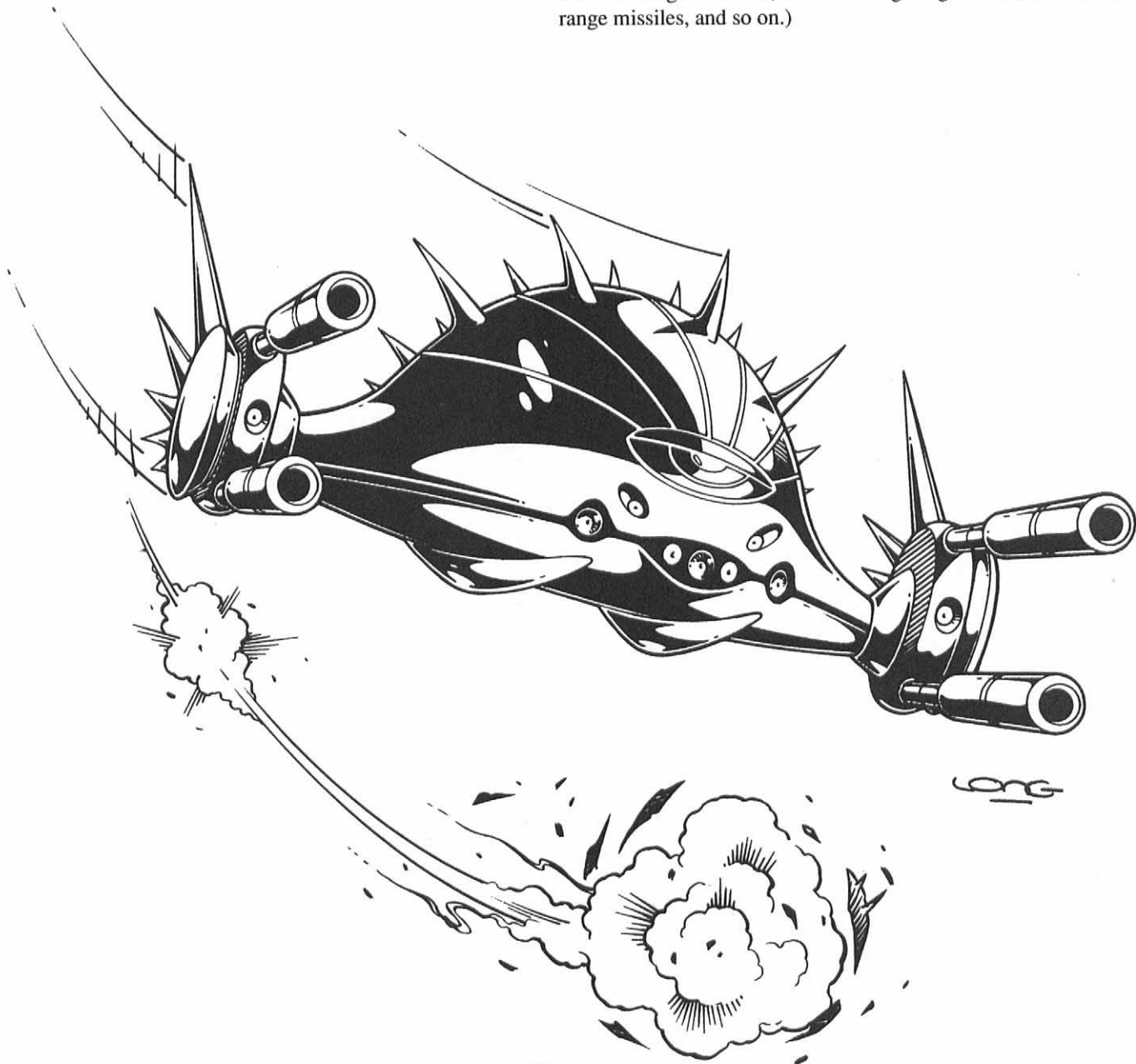

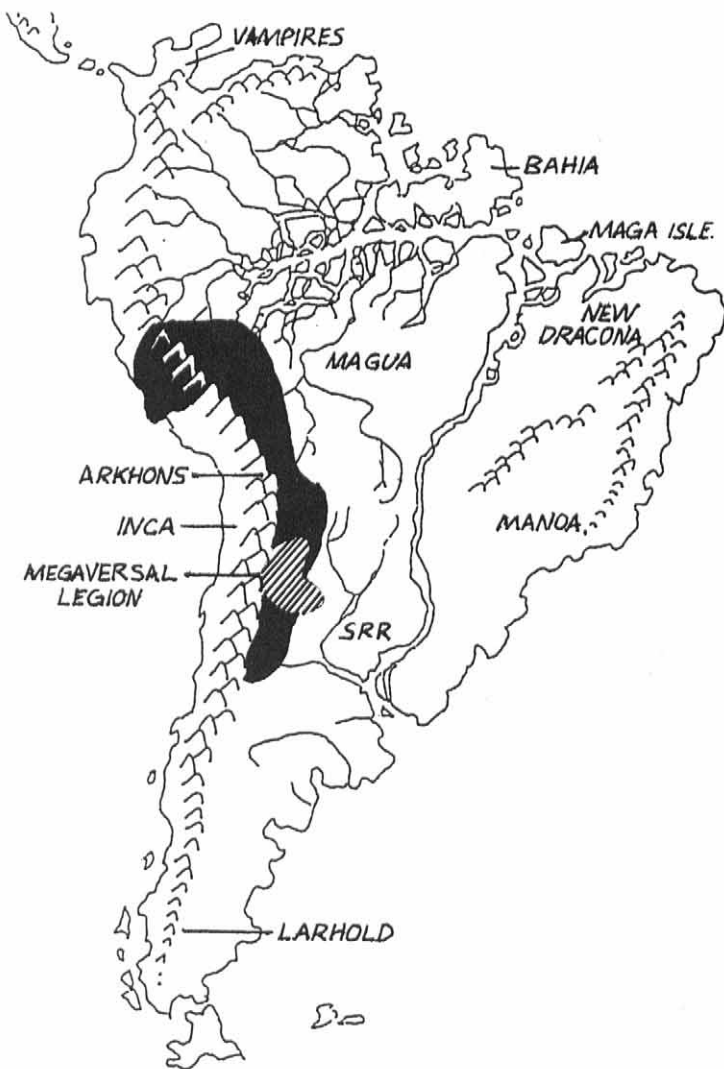

The Megaversal Legion

An Independent Mercenary Force

We were warrior slaves, recruited from a hundred worlds. But our former "masters" made one mistake. They enslaved free men from Earth, and brought about their own destruction.

— Lieutenant Colonel Harris, Chronicler of the Legion

A band of transdimensional mercenaries, known as the Megaversal Legion, have set up their headquarters in the mountains of Bolivia. The Legion is one of the largest armies for hire ever built, and also one of the most successful. It is made up of soldiers and warriors from hundreds of races, but the core of the legion is made up of two species. The first one is the *Ojahee* (pronounced Oh-jaw-hee), giant warriors of great strength, courage and discipline. The other is *humans* who were former U.S. soldiers kidnapped by aliens. The Legion was originally a slave army whose members were forced into service by a race of mer-

ciless aliens. In recent years, the slaves rose and destroyed their former masters, and now continue to sell their services, but as free soldiers.

In the Beginning...

Ojahee Jungles, M'korro, Year of the Black Dragon:

"They come."

"I can see them," said Warlord Okarr of the Ojahee, commander of the 3rd Rifles. The clearing he and his warriors had burned into the jungle in preparation for the coming attack was beginning to be covered by screaming Talian savages. Okarr smiled with grim anticipation. His muscles rippled under his dragon-skin armor as he clenched his sword, a ceremonial weapon nowadays, but still good to signal his warriors and as lethal in close quarters as it had been centuries ago, before the invention of the firesticks. He stepped forward, ahead of the well-drilled battle-line his warriors had formed at the call of the drummers. He raised his sword.

"Ready...!"

The Talians, howling madly, pressed on. A few paused to let loose a spear, an arrow, or a blowgun dart. Few of the missiles reached into the Ojahee lines, and even fewer penetrated the Ojahee's armor or thick hides. Here or there, a warrior staggered backwards, cursing or, if the Talian poison had gotten into their bloodstream, collapsing silently to their death.

"Aim..!"

As one, the first rank leveled their musketoons, the lethal weapons that shot half a pound of lead and could blow holes in anything but the sturdiest walls. Armed with musketoons, the Ojahee had conquered half the world. Today, a piece of the second half would fall. Okarr held his breath for a long moment, admiring his warriors, all selected for their size, strength and discipline; each a powerful eight feet tall, five hundred-pound block of solid muscle and lethality.

The Talians were getting closer. More arrows and stones scored marks, but the Ojahee didn't waver. Three hundred yards, two hundred ...

"FIRE!!!"

The earth trembled and the world disappeared in a huge cloud of black powder smoke. Even half-deafened by the massive volley, Okarr could hear the screams of agony as five hundred half-pound balls cut a swath of destruction among the Talian savages. The first rank stepped back, leaving enough room for the second rank to advance and ready their weapons.

"Second rank, FIRE!!!"

The second volley was as precise and measured as the first. Although the soldiers could not see through the cloud of smoke, accuracy wasn't necessary: the Talians had been massing for a final charge, and a bullet that missed a warrior would hit another further down the line.

"Fix axes!"

The two ranks with the unloaded musketoons affixed axe-heads to the sides of the barrels. As the smoke cleared, Okarr saw the axes would be needed. Although horribly mauled by the double volley, the Talians pressed on, their warriors just as tall

and strong as his own. Here and there, however, a Talian wavered as he saw the line of axe-heads glittering in the sun. Okarr smiled. A quick charge would finish them off, and if that didn't work, four more ranks of musketeers were ready to pour lead down the enemy's throat.

Suddenly, the Talians stopped their charge. Warriors tripped over their own feet, staring fearfully at the sky above Okarr and his troops. Screaming in the terror, the Talians who had braved gunfire and cold steel fled like scared toddlers.

"Warlord! Above us!" yelled Okarr's sergeant-at-arms. The warlord could sense fear coursing through his army. He turned around and looked.

At first, he thought he was seeing four of the airships that had just entered service in the Ojahee armies. Then he realized with a shock that these floating things were easily five times the size of the largest airship he'd seen. These flying things did not belong in his world. If he had been an ignorant savage like the fleeing Talians, Okarr would have thought of spirits and demons, but he was educated and knew of machines and technology. These beings must be aliens from another world, just like the ones fantasists wrote about in plays and novels.

"Warriors!" A voice said in the Ojahee tongue, louder than the largest loudspeaker used by the High Kings. "You will come with us, fight for us on other worlds! Follow our orders, and you shall live! Disobey, and ..."

A beam of red light came from one of the ... objects ... above and raked the Talians as they fled into the jungle. Dozens, no, hundreds of the savages were incinerated. The smell of burning flesh soon filled the clearing.

"Do we fight or run, milord?" the sergeant of arms whispered urgently. The tough campaigner could see no other alternative under these circumstances. Okarr, however, could.

"Hold your fire, everyone!" he roared. His voice steadied the warriors, some of whom were wavering. "Dying here, in this manner, serves no one's interests. Let us obey these strangers, and learn their ways." Okarr knew he didn't have to say more. The Ojahee had learned many secrets from other nations and cultures, and in the end had turned that knowledge against their "teachers." Come what may, the aliens would pay for making slaves of Ojahee warriors.

The two thousand warriors and the three hundred females in the medical brigade marched silently towards the ships, to whatever destiny the future held for them.

Iraqi Desert, Earth (one of many Earths?), 2004 A.D.:

Colonel Arthur Savage of the 7th Armored Cavalry studied the computer display in his command vehicle, going over the deployment figures with some apprehension. A veteran of Desert Storm, he was familiar with the terrain, the land and its people. But today he was facing a different foe. Who would have thought that the Turks would become the next "evil Empire?" Even worse, an evil empire using the same weapons and equipment as his reformed regiment did. The U.S., after spending decades cutting back the military budget, had to scramble to rebuild the military. His regiment was brand-new, a resurrected version of the ill-fated 7th Cavalry. The 7th, as in Custer's Last Stand. Not the best of omens, but the regiment was faring well so far.

All around him, the armored cavalry regiment moved over the desert plateau. They were protecting Iraq from Turkey, but contact with the enemy was days away. Air superiority had been achieved, and the only thing bothering the U.S.-led multinational coalition was the sudden influx of UFO reports. Savage snorted; there had been UFO reports in every modern war. They made for a break in the routine, but meant nothing.

A bright flash filled the compartment of the Bradley Fighting Vehicle. For several moments, Savage groped blindly, but eventually his vision started to clear. Across every radio channel, and in the compartment itself, everybody was shouting, a Babel of voices. "What the hell?" he started to say. Then he looked at his command screens.

All the satellite channels, every link outside the regiment, were silent. But even that paled to insignificance compared to the visuals on the video. He shifted viewpoints, over and over, and every camera mounted in every vehicle in the regiment told the same story.

The 7th Cavalry was no longer in the Iraqi desert. They were in a red-earthen plain, flat and featureless except for distant monoliths (mountains?) of improbable size, looming high on the horizon. The sky was an angry shade of scarlet, marred only by occasional pinkish clouds. Three stars, one slightly brighter than the sun, two much smaller, made a long triangle overhead.

"What the ...?" Colonel Savage's words were cut short by a flash of light that again blinded him and obliterated everything.

Arthur Savage woke up with a murderous headache. He could hear groans of pain all around him, and as he surveyed his surroundings he saw his troops, scattered all around him, each wearing some unfamiliar type of underwear. They were all in a huge room, the size of an aircraft hangar, and... Savage blinked, or tried to; everybody in the room was wearing some sort of wrap-around glasses and a metal helmet. Then he realized he had them on, too. He tried to remove them, but could not. With terror he realized they were grafted on. He wasn't the only one to make that discovery; his scream mixed with the screams of dozens of others.

"Never fear, humans," a voice boomed from a loudspeaker, drowning out their cries. You have been improved to better serve us. Remember that. Your goal in life is to serve our needs. Obey, and you will be rewarded. Defy us, and you will suffer."

Savage stopped shouting. The incipient attack of hysteria had been stilled. Replaced by thoughts of vengeance. "One day," he mentally vowed, "whoever had done this would pay. It might take years, but they would pay."

Many Years Later

Savage mentally adjusted his cybernetic visor. The lenses zoomed in on the Brodkil corpse on top of the destroyed APC. The creature was horribly burned, but enough of it remained to identify its species; brodkils were inhumanly tough and strong. Those qualities hadn't helped the Brodkil any more than its advanced vehicles had. Savage continued scanning the battlefield. The shattered remains of the Brodkil 3rd Armored Division littered the valley. Savage hated brodkils; the brutal, sadistic monsters were a plague on a thousand worlds. On this particular planet, they had allied themselves with an advanced culture and had developed huge mechanized armies. The last and largest of those armies had met its end here, in the valley.

"We won," he muttered.

"Was there ever a doubt we would win?" a rumbling voice said behind him.

Savage didn't turn around. His cybernetically-enhanced hearing had picked up the approaching Ojahee commander several seconds before. The giant aliens were great warriors, but were not built for stealth. "Nothing's ever certain, Okarr," he replied. "If those idiots hadn't rushed into the valley, if their intelligence had been any good — they outnumbered us six to one; their tanks were damn good. Hell, each of those Brodkil's as tough as a tank on his own!"

"As are we," Okarr said. Colonel Savage wasn't sure whether he meant the Ojahee warriors or all Legionnaires. In either case, he was probably correct.

"This should finish the campaign," the Ojahee continued. "The Brodkil do not have enough living to bury their dead. Their factories are smashed, and intelligence reports their shattered armored company is running out of fuel and ammo. They can surrender, or we can wipe them out. The Sylvan States got their money's worth when they hired us."

"Once again, the Legion wins," Savage said tonelessly.

"Yes, Arthur, the Legion won. But who profits? The damned Dakir," Okarr made the last word a curse. "Our owners and masters." At Savage's alarmed expression, Okarr smiled. "Do not worry yourself, Arthur. The spy-machines they drilled into our skulls no longer tell tales. I have seen to that."

"You disabled the skull mikes? How?"

"The Brodkils' slave scientists are very talented, my friend. I was able to phrase my request so our masters did not suspect. As of five minutes ago, the Dakir can neither spy on us nor send the death signal to the bombs they put into our bodies. We are free, for the time being. The final decision rests with you, old friend."

Savage blinked. A lot of information, all coming in at once, but he was used to making snap life-and-death decisions. "A revolt, then. We take them on."

"Yes, and you must lead. The Legionnaires will not follow me. Only the Ojahee, and maybe not all of them, not anymore. But you have the gift of leadership. Together, we can defeat them."

"The Dakir always kept us from their best weapons and equipment," Savage lamented.

Okarr spat over the side of the command vehicle. "Phaugh! This for the Dakir! If they were any good at fighting, they wouldn't have needed to enslave us. And we are the best. We will prevail! And this time, we will fight for our own sake. I believe this. Do you, Arthur?"

Instead of answering, Arthur keyed his personal radio to Public Address. "Attention all units. We have a Condition Red. All units, be ready to march within fifteen minutes. Blue-One, out." He turned to Okarr. "This time, we will fight for our own sake."

Nineteen hours and three thousand and sixteen lives later, it was over. It was brief and violent, and ended in a giant red explosion as the last Dakir ship died trying to escape. When it was over, the surviving soldiers of the Megaversal Legion, were free.

The Dakir Race

Little is known about the Dakir race. The homeworld and origin of their planet remain a mystery to even such transdimensional explorers as the Splugorth, the Naruni, and True Atlanteans. The only Dakir seen regularly are those involved in the mercenary trade, either (rarely) as soldiers themselves or as the purveyors and agents of mercenary companies. The Dakir have reached one of the highest levels of technology in the Megaverse. Even in such high-tech universes as the Phase World/Three Galaxies milieu, Dakir technology tends to have the edge in lightness, efficiency and durability. **Naruni Enterprises** (see *Rifts Dimension Book Two: Phase World and Rifts Mercenaries*) constantly try to smear the Dakir as evil, opportunistic cheats and con-men, but such attacks only conceal the fact that the Dakir could be the top weapon merchants of the Megaverse if they so wished.

That is not the case, however. The Dakir never sell their weapons — they rent out soldiers who use them against others. For some reason, the Dakir prefer to use slave soldiers, which has often canceled out the advantages of their technology. Why they want to be in the mercenary business rather than the weapons market (a much more lucrative and less risky endeavor) is also a mystery. *Rumors* link the Dakir to some obscure god or alien intelligence dedicated to war, but no proof has ever been offered. Some Xenologists believe that the Dakir's behavior is cultural; maybe they are afraid to trust other civilizations with their weapons, so they want to have utter control over those who use them.

History

The Megaversal Legion is the most ambitious project of the Dakir yet. For several centuries, the mercenary company was under the control of *Dakir Military Services*, a transdimensional corporation similar in some ways to the nefarious Naruni Enterprises. Masters of transdimensional travel, the Dakir were able to offer their services to thousands of worlds. Soldiers were recruited from relatively primitive planets, enslaved, and forced to fight. From the Dakir perspective, having slaves fight for them was cheaper (no bothersome division of loot or salaries), more convenient, and it gave them complete control over the operation.

The Megaversal Legion first appeared in transdimensional affairs some 1,000 Earth years ago. They joined a war between a Splugorth lord and a planet ruled by god-like beings, fighting against the Splugorth. The Legion's baptism of fire was not particularly distinguished. Although they held the defensive position they had been assigned to, they suffered over 50% casualties (all of them slaves). Worse, an entire regiment tried to run away, but came back to fight after the Dakir overseers killed one-tenth of their numbers! Despite this, the Legion was able to fight off an equivalent number of Kittani veterans. This success led to more contracts.

For centuries, the mercenary system worked, but the Megaversal Legion was never as successful as the Dakir had hoped. Although equipped with excellent hardware (booby-trapped in case the slaves tried to turn it against their owners) and cybernetic

and bionic systems, the mercenaries did not fight as well as they should. The Dakir tried to find better slave-soldiers, looking for war-like, yet disciplined races. They had made it their practice to always capture slaves in small groups of different races. In a change of policy, they decided to enslave two large groups of the most promising species. The selected races were *humans* and the *Ojahee*. The humans they selected were U.S. soldiers, an entire armored regiment of them, from an Earth time-line in the early 21st Century. The soldiers, led by **Colonel Arthur Savage**, acquiesced to the aliens' orders, but only so they could find a way to escape or defy their captors. The Ojahee, a warrior society that valued resourcefulness and courage, also surrendered for the same reasons. The two species, outwardly very different, managed to strike a fast friendship which developed into mutual admiration.

For almost twenty years, the humans, Ojahee and creatures from a hundred worlds and dozens of races were forced to fight for the Dakir. Their bodies were altered through cybernetic and bionic implants, ultra-tech versions of M.O.M., and other mergers of flesh and machine. When their bodies started becoming old and losing vitality, they were cloned new bodies and their brains were transplanted into them. Only death would free the Legionnaires from their masters. A few committed suicide, but most fought on, hoping to gain revenge one day. During their time as slave soldiers, they mastered the arts of war, becoming veterans with more years of experience than almost any other force ever created. The U.S. 7th cavalry and the Ojahee Third Rifles provided the Dakir a core of trained soldiers who fought for the good of their regiments, not because their masters demanded it, and they fought well.

One of the Legion's most glorious moments occurred on Arctares' World, where the mercenaries were assigned to protect the evacuation of one billion people — just as a *Mechanoid* horde was descending on the planet! Despite being outnumbered a hundred to one, the Legion was able to hold off the Mechanoids for 19 hours, the time needed to evacuate the refugees via dimensional gates. The Legion suffered only 7% casualties (dead) and 9% wounded, while achieving a kill ratio in excess of 30 to 1! In this and dozens of other wars, the new Megaversal Legion distinguished itself and became the most efficient (and desired) mercenary company in the Megaverse, winning almost every conflict in which they participated.

On 50 P.A. (Rifts Earth calendar), the Dakir, flushed with success, wished to relocate their ever-expanding legion. Rifts Earth was selected because it was a natural transdimensional "crossroads," an ideal staging point to travel on to hundreds of different worlds. An isolated valley in the Andes mountains was selected for its remoteness from the rest of the planet. The settlement brought about conflict with the Inca Empire of the Sun, but the Dakir's superior technology allowed them to push out the Incas and build their bases.

The Mutiny (68 P.A.)

Rebellion is common among slaves, but the Dakir had taken steps to guard against it. All the weapon systems had computerized booby-traps that would cause the weapons to explode if they were ever turned against a Dakir. Transmitters implanted in the skulls of the slaves reported every single word the Legionnaires said, making conspiracies impossible. Furthermore, the

Dakir had personal force fields to protect them against hand to hand attacks, and their personal weapons were much more powerful than those of their slaves. For hundreds of years, these measures worked. However, they didn't count on the inventiveness of humans and Ojahee.

The opportunity presented itself in a far-off dimension where a Brodkil horde, equipped with advanced weapons, was threatening the peaceful Sylvan Federation. The hapless federation, made up largely of Elves, knew enough about transdimensional politics to call for help, and they worked out a deal with the Dakir. The Megaversal Legion was once again mobilized, and in a series of battles, they completely destroyed the Brodkil armies.

As luck would have it, the Brodkil had enslaved hundreds of brilliant scientists of the **Men-Rall race** (see below) during their reign of terror. The freed scientists and tinkerers were not only grateful to the Legion for their freedom, having been slaves themselves, they understood and sympathized with their plight. One of the Men-Ralls was able to help neutralize the beamed communicators that linked the Dakir to their slave soldiers, and also disarmed the self-destruct mechanisms in the Legionnaires' weapons. Able to attack their former masters with impunity, the Legion returned to its base on Earth and launched an assault against their former headquarters. 90% of all the Legionnaires joined forces with the rebels; the rest were remnants of the cowardly and ineffective original Legion who were quickly overwhelmed.

The Dakir themselves were the toughest challenge. Their personal weapon systems were incredibly effective, and only quick thinking and brilliant strategies were able to overcome them. In the end, however, all the Dakir at the Andes base were killed or captured. The Megaversal Legion had triumphed and was now an independent organization.

Freedom did not mean a completely happy ending, however. Although the Legion headquarters had (and still has) dimensional portals leading to a number of worlds, they did not connect to any of the Legionnaires' home planets. Also, the Legion members feared that if they abandoned their weapons, the Dakir would hunt them down on their home worlds to get revenge. The only way for the Legionnaires to survive was to remain a military unit. For most of them, it was the only way of life they knew; many of them had married other soldiers, and had children who, in turn, grew up to become soldiers. Consequently, the vast majority of soldiers stayed together. The Megaversal Legion continued to offer its services, but now it would accept only contracts that were acceptable to its members, and its profits went to a common fund after meeting the upkeep and other expenses. Today, most veterans are wealthy or at least well-off. Some have retired but still live in the mountain community, now renamed **Fort Desperado**. The armed camp has become a small country, with people living in the mountains and valleys, right on top of the pre-Rifts ruins of La Paz, once the largest city in Bolivia.

The Legion has been an independent organization for almost forty years now. Many of the original veterans live and fight on, kept youthful through Dakir technology. General Arthur Savage, who should be in his nineties, is still the leader of the Legion, still as active as always. In recent years, the former members of the 7th Cavalry have discovered they are back on Earth, although it is *not* the world they grew up in, and they have become

more interested in its affairs. The Megaversal Legion *may* soon become involved in the conflicts ravaging Rifts Earth, and may become an important factor in the world — provided the Dakir do not seek their destruction.



Government & Society

The Legion remains a military organization, but its control now extends over a large civilian population; a combination of retired Legionnaires, children and dependents of the mercenaries, factory workers, maintenance workers, etc., living in and around Fort Desperado. Before the Mutiny, the Dakir had utter control over everyone's life; all were slaves under them. After the successful uprising, the Legionnaires had to come up with a new form of government.

The Megaversal Legion is now commanded by the Joint Chiefs of Staff. Each Commander in Chief (CINC) is in charge of a separate branch of the Legion. There is a CINC-Army, CINC-Air, CINC-Navy, CINC-Logistics, CINC-Intelligence and CINC-Civilian Affairs. Overseeing them is the CINC-MEL (Commander in Chief, Megaversal Legion). For the last 40 years, General Savage has been the CINC-MEL. In addition to the Joint Chiefs, the civilian population of Peace City (built on the ruins of La Paz) elects a Mayor every five years. The Mayor's office has no jurisdiction over military matters, but is in charge of the administration of the city; CINC-Civilian Affairs (or CINC-CA) is the liaison between the Joint Chiefs and the Mayor's Office.

The former slave company is now a volunteer army. The terms of enlistment are two years, at the end of which one is free to leave the Legion with a small pension (roughly equivalent to 100 credits a month; the pension grows the longer a soldier serves in the Legion). 80% of the Legionnaires serve for ten terms (20 years) of enlistment or more! The children of the Legionnaires and the-civilian population make up most of the recruits (70%). The remaining 30% are volunteers from all corners of the Megaverse who typically join the Legion when it is campaigning on their home world. The bionic reconstruction most slaves were forced to undergo is now optional; 75% of all new recruits end up volunteering for it as well.

Between assignments, life in the Legion can be fairly peaceful and pleasant. Defense pickets ensure that no threat can reach *Peace City* and *Fort Desperado*, so war and violence rarely mars the community. Peace City has grown over the last three decades; the fact that thousands of soldiers with a lot of cash are given leave to go into the city has led to the construction of casinos, bars, "escort houses" and all manner of entertainment (see *Peace City*, elsewhere in this section).

The Megaversal Legion is still a mercenary organization. Nations and planets with transdimensional capabilities can contact them. All kinds of jobs, from small-unit training duties to full-fledged wars, are taken by these warriors of renown. For the most part, however, the Legion refuses to accept jobs that in-

volve enslaving or massacring innocent victims, although they will readily accept missions *against* such miscreants.

Foreign Relations

The Empire of the Sun: The Inca territories are on the other side of Lake Titicaca; the entire lake is considered to be Inca territory, and the Megaversal Legion respects this. In the past, the Dakir had used the lake as a training area for their few water vehicles, but this is no longer done. Relations between the Incas and the Legionnaires are somewhat cool but not hostile. When the Dakir occupied the region, they did so through violence, expelling thousands of Bolivian survivors of the Great Cataclysm and cutting off a number of Inca cities in the plains to the East. As a result, the Incas and the Legion had a number of violent encounters. After the Legion overthrew their Dakir overlords, it sent a diplomatic mission to Cuzco. The results were unsatisfactory, but at least there is no overt warfare between the two nations.

The two powers recognize the Arkhons as a common enemy, so they leave each other alone. The Legion does not trust the "gods" that are said to rule the Empire, and the Incas' followers still have bad memories of American intervention, and see the human legionnaires as "gringos" not to be considered friends.

The Arkhons: The Arkhon Freehold is to the North of the Legion, across the no-mans-land that lies between the Empire of the Sun, the Freehold, and the human nations of Santiago and Cordoba. The aliens' attempts to expand into the Legion's territory have resulted in some nasty fighting across treacherous mountain passes and open battles in the plains. Although the aliens outnumber the mercenaries, the latter's superior equipment and tactics have won the day time and time again. The Arkhons have even tried to hire the mercenaries, but their offers have been refused. For the time being, the Arkhons have not pushed very hard against the notorious soldiers, afraid that one of their other enemies will take advantage of the distraction.

The Silver River Republics: The Legion has borders with Cordoba and the Achilles Republic. The human nation of Cordoba considers the Megaversal Legion to be an alien presence similar to the Arkhons, and often conducts raids against its territories.

The Achilles Republic has a friendly relationship with the Legion, and has even hired some contingents to help train its army. A number of mutant animals have joined the Legion.

New Babylon, a human-D-Bee enclave, is dominated by the Amaki race, who, in the past, has hired the mercenaries. Some Amaki and Babylonians have joined the Legion, and still others like to frequent Peace City. The main problem between New Babylon and the Legion is the latter's refusal to sell any of their Dakir equipment. The Joint Chiefs of the Megaversal Legion believe that Dakir technology should remain secret, because it often provides the Legion with the edge they need to survive. The Babylonians do not like but respect this decision.

The New Navy: Since the Legion's headquarters are landlocked, they have no direct contact with any seafaring civilization. However, some human legionnaires from the 7th cavalry have heard rumors of the New Navy, supposedly the heirs of the U.S. Navy who have somehow survived the Great Cataclysm and continue to protect the oceans. Although at this point, the Legion is the only home most of them know, some humans

yearn to return home, and link up with somebody with the same values they have (even if they are “squids”). Consequently, the New Navy is something that definitely attracts the interest and dreams of many humans. A small group of Legionnaires have taken a leave of absence to investigate these rumors. If they prove to be true, half to all of the Megaversal Legion *might* leave to join forces with the New Navy; the human members of the Legion have enough respect and influence to get that concession. The only possible stumbling block is the presence of so many aliens and D-Bees, given the New Navy’s view on non-humans (tolerant but not friendly towards them). More information about the New Navy and other ocean cultures can be found in *Rifts Underseas*.

The Coalition States: The Megaversal Legion has heard a few odds and ends about the Coalition States, but have never had any encounters with them. From what they hear, they know the CS are racist fascists, whose policies are too reminiscent of the Dakir and many of their past, ruthless employers for the Legionnaires to feel comfortable with them, even if they are reputed to be the “last bastion of humankind.”

The rest of the World: Ironically, the Legionnaires know more about the Megaverse than the “alien Earth” they have made their home. They’ve heard rumors about dragons, were-jaguars, vampires and demons to the south, and that the Splurgorth reign over a continent that is supposedly resurfaced Atlantis, but they know little more than that.

Megaversal Troops

The Megaversal Legion has 300,000 combat ready troops and 50,000 support personnel on its active duty rosters. These soldiers are divided into six Armies of 50,000 soldiers each. These six Armies are organized and equipped almost identically, and are designed to be self-sufficient. At least one entire Army must remain at Fort Desperado at all times to provide for its defense. Typically, another Army is also in the area, its troops relaxing and its equipment being refitted after a campaign. Also, since not all jobs require the hiring of an entire Army, most of the time elements of a third Army, the regiments not hired out at the moment, are also in the area. Meanwhile, at least 100,000 soldiers (roughly two Armies) are in service somewhere in the Megaverse at any given time.

Armies are organized in Divisions of 5,000 to 10,000 men each. The divisions are, in turn, made up of regiments of about 1,000 men each. Each regiment is a self-contained unit combining infantry, tanks, air support and artillery within the same unit. The regiment is, in turn, divided into companies of 100 to 200 soldiers each, or 12-20 vehicles or robots in the case of tank, robot and air companies. Companies are broken up into platoons of 20-40 soldiers or 3-6 vehicles, and the platoons are divided into squads of 5-10 soldiers (no equivalent with vehicles). The regiment is the smallest unit that can operate independently; it has its own headquarters, logistics and supply system, and all types of weapon systems available. Units smaller than a regiment are rarely hired out for war situations.

Cities Notes

Fort Desperado

Headquarters of the Megaversal Legion

Population Breakdown: 350,000 total (about 250,000 are full-fledged members of the Legion).

Humans 35%

Ojahee 15%

Wolfen 5%

Mutant Animals 5%

Lizard Men 2%

Larhold Barbarians 2%

Men-Rall 2%

Others 34%

Fort Desperado, once a military base, is now the size of a city, and is still growing. Although the majority of the population is made up of soldiers, a lot of civilians work in the military factories that produce the Dakir weapons used by the Megaversal Legion. The city is north of where the city of La Paz used to stand (see **Peace City**, below), and is surrounded by hills that rose during the great cataclysm. The hills are crowned by bunkers with enough firepower to destroy a tank column, and air-defense systems that can knock any aircraft out of sky; a fact many an Arkhon pilot attacking or scouting the area have discovered.

As the city grew, new neighborhoods have sprawled beyond the hills. These areas are less well-protected, but it has been years since enemies tried to test the defenses of the city.

East of the city are a number of empty fields used as firing ranges. Every other day, the sounds of explosions and energy discharges can be heard in the city. Beyond that there are farms where the produce that feeds both Fort Desperado and Peace City is grown.

The most notable building in the city is the Dimensional Dome. This round-topped building houses the **Dakir’s Dimensional Gate System (DGS)**. There are two types of DGS, a receiving platform and a projector. The receiving platform looks like a sound stage, surrounded by what appear to be spotlights but, in actuality, are dimensional beam projectors. Visitors using dimensional gates, pyramids and Rifts arrive on this platform. The projector looks like a huge gun, and is often mounted on a truck or a tank. The dimensional beam it “shoots” can bathe an area the size of a football field in seconds. The beam somehow causes the targets to shift out of phase and reappear in a separate dimension. This is a unique form of dimensional travel, perhaps related to the dimensional powers of the Prometheans from Phase World (for more information on the Promethean race see *Rifts Dimension Book Two: Phase World*).

The Dimensional Dome also has transdimensional communications equipment that allows the legion to contact and hear messages from many worlds throughout the Megaverse. This is the place where job offers are made.

Peace City (La Paz)

Population Breakdown: 300,000 (70% humans, 30% assorted races)

La Paz is built on the actual ruins of the Bolivian city of that name. At first, it was little more than a shanty town where the civilian slaves of the Dakir huddled after working in the mines surrounding the city. After the mutiny, it became a modern city. Thousands of former Inca and SRR citizens have migrated to this booming town, and its population has swelled with retired soldiers and their families, factory workers and even transdimensional emigrants.

The population of Peace City works in three major fields. Mining for raw materials still goes on in the surrounding countryside, although working conditions are much more humane than under the Dakir. Industry employs about 25% of the city's population; several factories produce goods not made in Fort Desperado, mostly non-weapon products like canteens, belts, shoes and uniforms, although a factory that makes nuclear power systems for robots and armor and another that manufactures and recharges E-Clips are in operation. Finally, entertainment accounts for 33% of the city's cash flow. **The Strip**, an area of over ten city blocks dedicated to movie theaters, casinos, restaurants, bars, nightclubs and "pleasure houses," is quite famous (or infamous, depending on who you ask). Even members of the Amaki race (see the *New Babylon* section) frequent this city when looking for a good time. Soldiers and miners, both of which make good money and like to spend it, are the main customers of the Strip. A force of detached Legionnaires acts as military police to make sure that no deadly fights break out, although brawls are not infrequent.

The Dakir Slavers

No Dakir remain alive at the Megaversal Legion's headquarters, but the race is not extinct by any means. These transdimensional slavers are still at large in the Megaverse, and many legionnaires fear their return. The worst part is that no living Legionnaire can claim to have seen a Dakir in the flesh! Messages and orders were always relayed through audio communications. The few times the Dakir walked among their slaves, they were concealed beneath robes and surrounded by semi-opaque force fields. The robes and cloaks appeared to conceal a humanoid but inhuman shape, and many soldiers have reported to have caught glimpses of purplish or green skin.

During the rebellion, the Dakir fought until dead. Their hand weapons fired beams of incredible power (3D6×10 M.D. per shot!). Their force fields withstood at least 1,000 M.D.C. of damage before collapsing, at which point a self-destruct mechanism would obliterate the Dakir and a 60 foot (18.3 m) radius around him (everything in that area would take 4D6×10 M.D.!). No remains were left after the explosion.

After years of investigating their former captors, the Megaversal Legion has amassed a pile of rumors, wild stories and speculations. Some of the more consistent ones are listed below:

- The Dakir are the minions of a renegade Splugorth.
- The Dakir are nothing more than a splinter group from Naruni Enterprises who hate each other, hence the acts of betrayal and secrecy.

- The Dakir are somehow related to the Gene-Splicers (see *Rifts Sourcebook Three: Mindwerks*). The two mysterious bands of dimensional travelers may be enemies, competitors or part of the same species.
- Some tales and even a couple of reports mention the Dakir as being involved in a war with a group of beings known as the **Techno-Gods**. The mercenaries continue to try to uncover more about these enigmatic beings.

Common R.C.C.s & O.C.C.s of the Megaversal Legion

In addition to the O.C.C.s and R.C.C.s described below, members of hundreds of races serve in the Megaversal Legion. Any race from the **Rifts**® sourcebooks, world books, and dimension books, including the *Rifts*® *Conversion Book One*, *Rifts*® *Dimension Book™ Two: Phase World™*, *Scrapers™*, and *Rifts*® *Sourcebook Three: Mindwerks™* can be found among them. More species of aliens can be found in the *Aliens Unlimited™* sourcebook and other Palladium RPGs and sourcebooks.

Additionally, the Legion recruits whole units of soldiers with unusual magical or psionic abilities. *Mind melters*, *mind bleeders*, *burstlers*, *psi-stalkers*, *temporal warriors*, *shifters* and *ley line walkers* all serve in the legion: use the appropriate O.C.C./R.C.C., but use O.C.C. related skills to acquire at least Hand to Hand: Basic, Basic Radio and W.P. Energy rifle (the minimum skills all trainees acquire).

Megaversal Trooper (Human) O.C.C.

Chosen for their ability and training, the human troopers of the 7th Cavalry were given a bionic edge to survive in the tough battlefields of transdimensional warfare. They were given (whether they wanted it or not) partial bionic reconstruction far more advanced than the Earth equivalent. All vital organs were replaced with mechanical M.D.C. structures, and protected by inner plating. The eyes were replaced by mirrored visor-like multi-optic systems, and metallic helmets protect their heads. A lot of their bone and muscle tissue were replaced by metallic fibers. After the mutiny, this extreme bionic conversion are optional, but as many as 80% of all human volunteers choose to undergo it. The soldiers look mostly human; even the optic system and helmets appear to be something worn, not grafted in. Underneath the skin is a powerful artificial frame — and underneath the frame is an all too human spirit.

About one-fifth of the human legionnaires used to belong to the 7th cavalry regiment, or are the children of such members. In

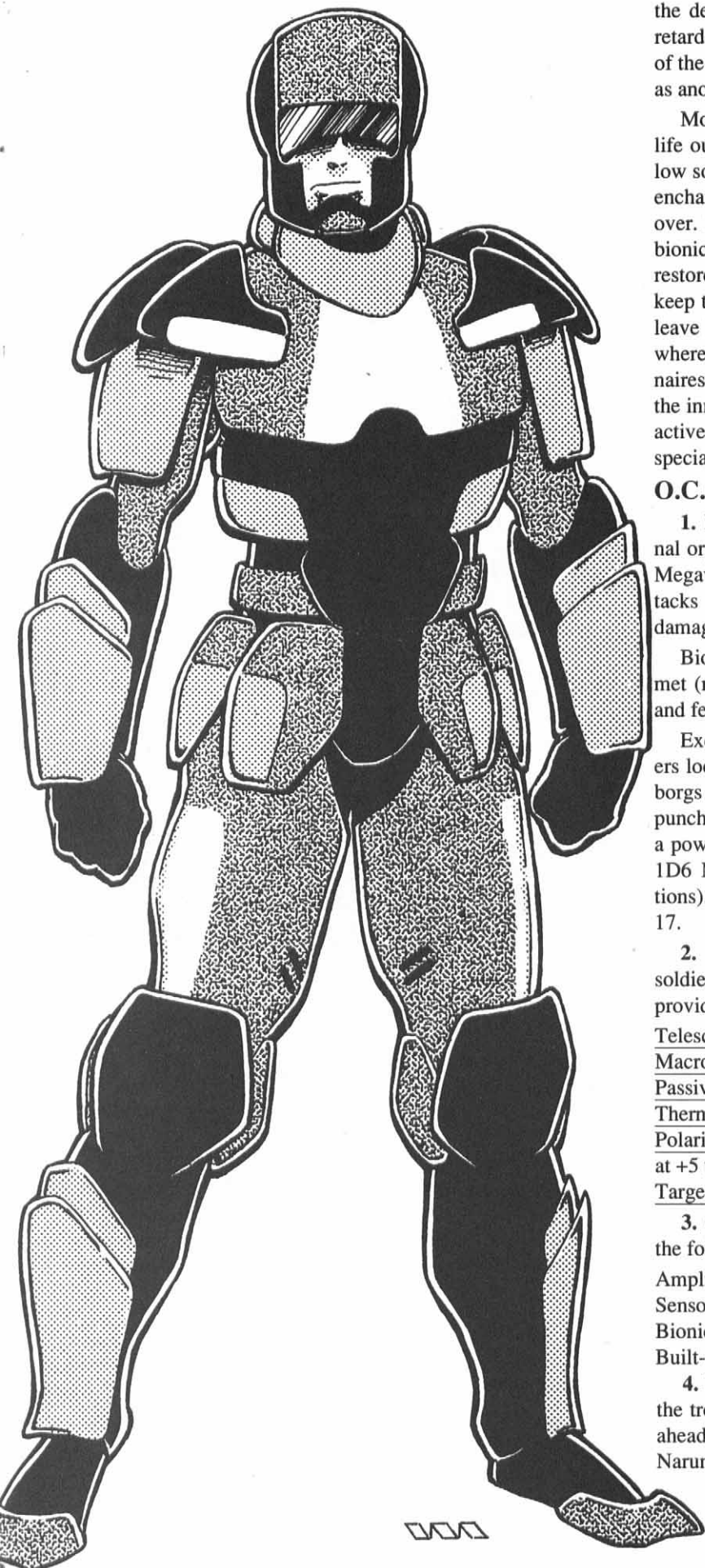

the decades since their abduction, the soldiers' aging has been retarded through genetic treatments, and even cut off from much of the Dakir's medical resources, they can expect to live as much as another hundred to one hundred and fifty years.

Most legionnaires are dedicated soldiers; they have almost no life outside their military outfit, and many end up marrying fellow soldiers and raising future soldiers. A few of them grow disenchanted with army life and resign after their tour of duty is over. Discharged veterans are given the option of having their bionic systems replaced with bio-systems and cloned organs to restore as much as 90% of their humanity, or they can elect to keep their powerful artificial frames. Former soldiers sometimes leave Fort Desperado and start new lives on Rifts Earth or anywhere in the Megaverse the Legion can reach. These ex-legionnaires run the whole gamut, from adventurers and defenders of the innocent to rogues and criminals. Their only distinction from active Legionnaires is they are not allowed to keep any of the special weapons that use unique Dakir technologies.

O.C.C. Abilities and Bonuses:

1. Partial Bionic Reconstruction: By replacing most internal organs, bones and muscle structures with M.D.C. alloys, the Megaverse Troopers are in effect, M.D.C. creatures. S.D.C. attacks will damage the skin and cause minor bleeding, but the damage will be largely cosmetic and easily repaired.

Bionic M.D.C.: 120 for the main body, 70 for the head/helmet (reinforced), 15 for the arms and legs, and 8 for the hands and feet.

Except for the helmet/visor grafted to their heads, the troopers look like normal humans. The artificial muscles give the cyborgs a P.S. of 30 (advanced cybernetic strength; restrained punch does 2D6+15 S.D.C., full strength punch does 1D4 M.D., a power punch does 2D4 M.D. and counts as two attacks), kick 1D6 M.D. leap kick 2D6 M.D. (but counts as two melee actions). Enhanced reflexes add +4 to P.P., for a minimum P.P. of 17.

2. Sensor Systems: The visors permanently grafted to the soldiers' faces act like advanced multi-system eyes. The visors provide the following abilities:

Telescopic: 10× magnification. Range: 6000 feet (1830 m)

Macro Lens: 10× magnification. Range: 3 feet (0.9 m)

Passive Night Vision: Range: 4000 feet (1220 m)

Thermo Imaging: Range: 3000 feet (915 m)

Polarized Filters: Allows wearer to look directly at the sun and is at +5 to resist dazzling lights.

Targeting Display: Adds +1 to strike with any weapon.

3. Other Cybernetic Systems: Additionally, the cyborg has the following bionic and cybernetic systems:

Amplified Hearing

Sensor Hand (actually installed in the head/helmet)

Bionic Lung and oxygen storage cell.

Built-in Language Translator.

4. Power System: The bionic and cybernetic components of the troopers are powered by a micro-antimatter power plant, far ahead of anything produced on Earth or even the Splugorth or Naruni factories! This power cell has an average energy life of

150 years. Only the Megaversal Troopers and the Dakir know of this fact; if such information would become known, a lot of people and creatures would do everything in their power to capture live troopers and study their power source. If the trooper is killed, the antimatter reactor goes inert and turns into a shapeless gob of metal, impossible to analyze or copy.

5. Bonuses: +1 to strike, +2 to dodge, +6 on initiative, +1 to strike with any weapon. Includes cybernetic system bonuses, but not attribute or skill bonuses.

Megaversal Trooper (Human) O.C.C.

Alignment: Any

Attribute Requirements: None.

O.C.C. Skills:

Language: Dakir (98%)

Language: Native tongue (98%)

Language: One of choice (+10%)

Basic Radio (+15%)

Detect Ambush (+10%)

Piloting: One of Choice (+15%)

Power Armor Combat: Elite

W.P. Energy Rifle

W.P. Energy Pistol

Hand to Hand: Expert

Hand to Hand: Expert can be changed to Martial Arts at the cost of one "other" skill.

O.C.C. Related Skills: Select seven other skills. Plus select one new skill at level three, five, seven, nine, and eleven. All new skills start at level one proficiency.

Communications: Any (+10%)

Domestic: Any

Electrical: Any (+5%)

Espionage: Any (+10%)

Mechanical: Any (+5%)

Medical: Paramedic only (+5%)

Military: Any (+10%)

Physical: Any

Pilot: Any (+5%)

Pilot Related: Any (+10%)

Rogue: Any

Science: Any

Technical: Any (+5%)

W.P.: Any

Wilderness: Any (+5%)

Secondary Skills: The character also gets to select five secondary skills. These are additional areas of knowledge that do not get the benefit of the bonus listed in parentheses. All secondary skills start at the base skill level. Also, skills are limited (any, only, none) as previously indicated in the list.

Skill Note: See *Rifts Japan* for a variety of "new" military skills, as well as new bionics.

Standard Equipment: Mark I body armor, ARP-1 plasma rifle or IAR-20 inertia rifle, one energy weapon of choice, 4 E-clips or spare magazines for each, survival knife, field kit, and first aid kit. Additional weapons, armor and equipment may be made available for special assignments.

Retired veterans do not get Mark I body armor or an IAR-20 inertia rifle; they are limited to plasma rifles, a suit of medium or heavy M.D.C. armor, and the equipment listed above.

Money: Pay is typically 2000 credits a month plus free room and board, his bionics, his standard equipment, and access to military facilities. During combat situations, soldiers get a bonus hazard pay of 800 more credits per month. Character starts with one month's pay.

Cybernetics: See above.

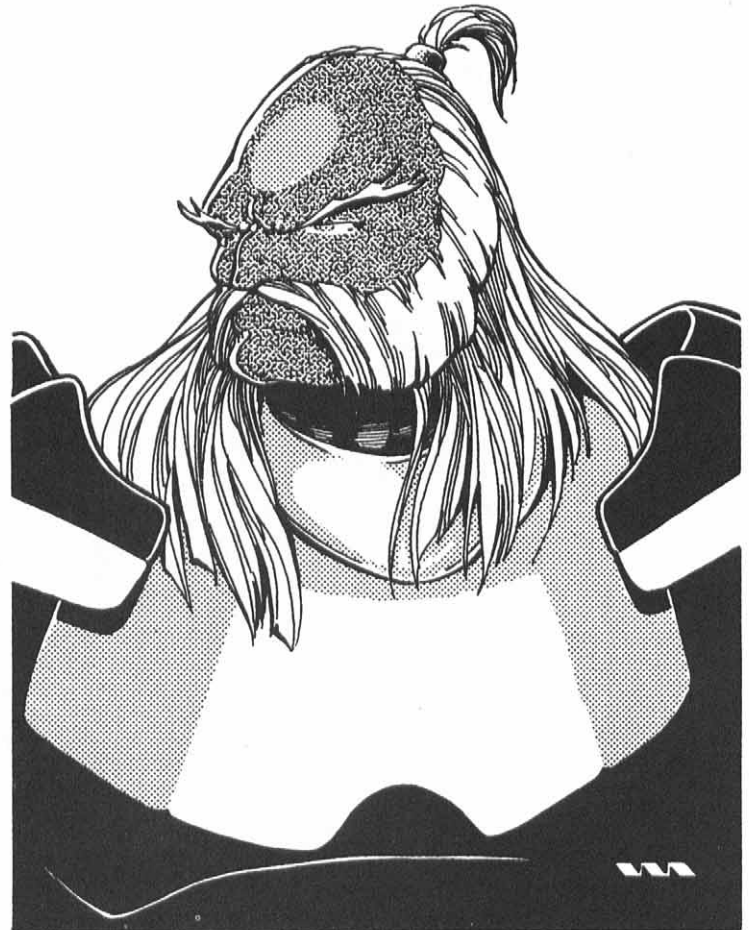

Megaversal Trooper O.C.C./Ojahee R.C.C.

The Ojahee are natives to a natural M.D.C. dimension (like most such dimensions, their home world has unusually high levels of P.P.E., roughly equivalent to those of Rifts Earth and Wormwood). Their civilization was just beginning to undergo the equivalent of Earth's industrial revolution. Warriors fought with black powder weapons (the Ojahee's size and strength allowed them to use the equivalent of small cannons as rifles), steam engines were being used in trains and airships, and factories were being built. The Ojahee (a national, rather than racial name) were an up-and-coming nation on their homeworld, a fierce warrior society that had learned a great deal from more advanced but decadent neighbors, and was now poised to conquer them and perhaps their entire world. At the time of the Dakir's kidnapping, the Ojahee were fighting savage jungle tribes called the Talians, and winning.

The kidnapped regiment, the 3rd Rifles, was a well-trained, highly capable force. Its tactics consisted of using rifle volleys

and then charging with their axe bayonets. Under the Dakir, they've been trained to use cover and move in a flexible skirmish line rather than a solid block of infantry, but they are still excellent shock troops. With their heavy body armor and personal force fields, the Ojahee can go toe to toe with armored vehicles, and their heavy plasma rifles are the equivalent of a tank gun in terms of firepower.

As a race, Ojahee respect courage, inventiveness, creativity and honor. They are used to constant warfare, and the Ojahee legionnaires are even more war-like than their brethren back home. They see in humans a kindred species, and refer to them as their "little cousins." To the Ojahee, humans are inventive, child-like creatures (due to their relative small size). At best, this attitude leads to lasting friendships between members of the two races. At worst, some Ojahee treat humans in a patronizing way.

Ojahee R.C.C.

Alignment: Any

M.D.C.: P.E. x5; add 10 per level of experience.

Attributes: I.Q. 3D6, M.E. 3D6, M.A. 3D6, P.S. 2D6+18, P.P. 3D6, P.E. 3D6+10, P.B. 2D6, Spd. 5D6. Supernatural strength and endurance.

Size: 7-8 feet (2.1 to 2.4 m)

Horror Factor: 8

P.P.E.: 3D6

Average Life Span: 90 years (Note: Ojahee M-Troopers have bionic replacements and cloning treatments that can conceivably raise this to 300-400 years!).

Natural Abilities: Fast healing: recover 1D6 M.D.C. every 10 minutes.

Experience Level: Varies. NPCs average 2D4+1; player characters start at the first or second level of experience.

Combat: As per hand to hand skill. Add one additional hand to hand attack at level one.

Damage: As per supernatural strength (see *Rifts Conversion Book One*, page 22).

Bonuses: +2 to save vs horror factor, +10% to save vs coma/death.

Magic Powers: None. Ojahee distrust magic and prefer to rely on technology.

Psionic Powers: Very rare; only 1% have psionic powers of any kind; of those, 80% are minor psionics and 20% major psionics. Master psionics are unheard of (a mutation might give an individual Ojahee such powers, but their frequency would be less than one in a million!).

Vulnerabilities/Penalties: None.

Megaversal Trooper (Ojahee) O.C.C./R.C.C.

R.C.C. Skills:

Language: Dakir (98%)

Language: Native tongue (98%)

Language: One of choice (+10%)

Basic Radio (+15%)

Detect Ambush (+10%)

W.P. Energy Rifle

W.P. Energy Pistol

W.P. Axe (treat as W.P. Blunt)

Hand to Hand: Expert

Hand to Hand: Expert can be changed to Martial Arts at the cost of one "other" skill.

R.C.C. Related Skills: Select six other skills. Plus select one new skill at levels three, six, eight, eleven, and thirteen. All new skills start at level one proficiency.

Communications: Any (+10%)

Domestic: Any

Electrical: Any (+5%)

Espionage: Any (+10%)

Mechanical: Any (+5%)

Medical: Paramedic only (+5%)

Military: Any (+10%)

Physical: Any

Pilot: Any (+5%)

Pilot Related: Any (+10%)

Rogue: Any

Science: Any

Technical: Any (+5%)

W.P.: Any

Wilderness: Any (+5%)

Secondary Skills: The character also gets to select six secondary skills. These are additional areas of knowledge that do not get the benefit of the bonus listed in parentheses. All secondary skills start at the base skill level. Also, skills are limited (any, only, none) as previously indicated in the list.

Alliances and Allies: Ojahee M-Troopers rely mostly on the Legion and have few other allies.

Standard Equipment: Mark II body armor, HRP-1 plasma rifle or HIAR-22 inertia rifle, one energy weapon of choice, 4 E-clips or spare magazines for each, survival knife, field kit, and first-aid kit. Additional weapons, armor and equipment may be made available for special assignments.

Retired veterans do not get Mark II body armor or an HIAR-22 inertia rifle; they are limited to plasma rifles, a suit of medium or heavy M.D.C. armor, and the equipment listed above.

Money: Pay is typically 2000 credits a month plus free room and board, his equipment, training and access to military facilities. During combat situations, soldiers get a bonus hazard pay of 800 more credits per month. Starts with one month's pay.

Destroyer 'Borg O.C.C.

These are human or humanoid troopers who undergo *total* bionic reconstruction, becoming, in effect, a robot with a human brain. These cyborgs are trained to work in small units (typically 3-12, a squad having 12 members divided into 3-man teams). Their missions include scouting, surgical strikes, and long-range missions without much in the way of support. Since the cyborgs don't need food or water (the brain and small pieces of spinal cord left in the body are fed through internal systems that will last one or two years without renewal), and they can supply power for their energy weapons through their personal power plants, they can be sent on long-term missions, sometimes lasting months. Some mission examples include setting up an ambush position and then waiting for the enemy to show up, whether it takes hours, days, weeks or months; infiltrating enemy lines with a number of 'borg teams to "soften" their defenses before a main attack; and searching for enemies in jungle warfare.

The advanced bionic systems provided by the Dakir make these cyborgs extremely stealthy, fast and maneuverable. To increase their stealth and movement capabilities, the 'borg has a nearly skeletal shape (only a metallic "spinal column" links the upper torso with the legs, for example). The head is sculpted to suit individual tastes. The cyborgs enjoy having intimidating or monstrous designs on their faces and heads, the better to scare off their enemies. A special system included in the 'borg package is a virtual reality simulator that 'borgs can access during their free time to avoid boredom and depression. The VR system allows the 'borgs to live out any fantasies and temporarily escape their grim reality.

Destroyer 'Borg Abilities and Bonuses:

1. Full Bionic Reconstruction: The Destroyer 'borgs undergo full bionic conversion, replacing 95% of all body mass with metal, plastic and ceramic components. Only a small fraction of the brain/spinal cord remains human, buried deep in the heart of the machine body. In effect, the character is a robot with a human brain, and his strength and endurance become 100% robotic. This extensive reconstruction and the use of highly advanced alloys (at least 50 years ahead of what Triax is currently capable of) produces a tougher, yet lighter cyborg warrior.

M.D.C.: 300 for the main body; arms and legs have 45 M.D.C. each; hands and feet have 20 M.D.C. each. The spinal column can be targeted separately (called shot, -5 to strike); it has 100 M.D.C. Note: This 'borg cannot use any normal suit of cyborg body armor, but can use normal humanoid body armor.

2. Force Field (150 M.D.C.): Destroyer 'borgs do not wear body armor. Instead, they rely on a silent, invisible force field that absorbs and deflects any incoming attack, be it energy or physical. The force field is modulated so that it doesn't interfere with movement up to running speed, but it automatically activates whenever fast-moving objects (bullets, punches) or energy beams are about to hit the cyborg. The field protects with an M.D.C. of 150, and can be activated three times before needing a three hour charging period (it takes one hour to recharge for one activation; the cyborg's internal power supply takes care of the recharging). This force field precludes the use of an inertial shield.

3. Inertial Shield: In addition to the force field, the 'borg has an inertial shield. This special energy shield cannot be activated when the force field is turned on. When activated, the inertial shield senses incoming physical attacks (like bullets, arrows, rail gun rounds, etc.) and creates a small shield in the path of the attack. This works like a parry; the automated shield has a +3 to parry. If successful, the missile loses all forward momentum and falls to the ground; no damage is taken. If the parry fails, the attack hits, but does half damage. The inertial shield can parry up to three attacks in a round; these parries are in addition to the character's hand to hand attacks, but cannot be used against hand to hand attacks. **Note:** The limitations of the shield are such that it cannot stop punches, kicks, melee weapons (swords, vibro-blades) or energy attacks (lasers, ion, plasma, etc.)

4. VR System: This virtual reality system is built inside the cyborg's skull and can store up to four "features" in its data base. Each feature consists of an artificial environment. While it is activated, the 'borg enters a trance state and, in his mind, he can interact with the virtual environment. The character can look

like his own self, or have any shape he programs into the system. The Dakir left behind an abundance of different features for the entertainment of the cyborg warriors. Among them were forest scenes, love stories, heroic adventures, sports tales, etc.

5. Robotic Attribute Bonuses: Reflexes, strength and speed are well above the human norm, or even the limits of normal cyborgs. The character gains a robotic P.S. of 35, P.P. 26., and speed running is 70 mph (112 kmph). Plus the stealth systems add +5% to prowl (the 'borg design does not have a prowl penalty like the normal full conversion cyborg does); enemy sensors are at -15% to detect it, and the 'borg is -15% to be sensed by detect ambush, tracking or similar skills. Additionally, advanced optical and targeting systems grant the cyborg a number of combat bonuses.

6. Sensory Bonuses: Advanced bionic sensors give the 'borg the equivalent of multi-optic eyes (as per the visor described under the Megaversal Trooper O.C.C.), amplified hearing, motion detector, radar detector and personal radar (range: 5 miles/8 km).

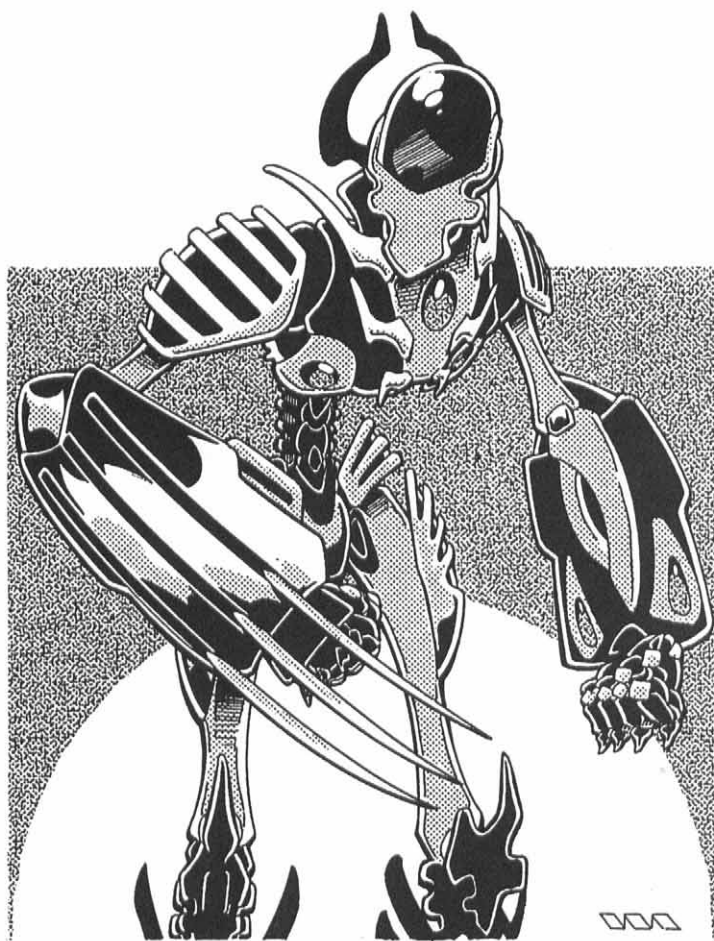

7. Implanted Weapons: The Destroyer 'Borgs have a built-in particle beam blaster (6D6+6 M.D., range 500 feet/152 m) and three slashing vibro-sabers that extend from one of the wrists (the 'borg gets to choose which wrist has the retractable blades). These blades inflict 3D6+6 M.D. in hand to hand combat.

8. Total Combat Bonuses: The combined cyborg bonuses (includes attribute and R.C.C. bonuses but not skill bonuses) are: an additional attack per melee, +3 to initiative, +4 to strike, +1 to strike with any ranged weapon, +6 to parry, +8 to dodge, +3 to pull punch and +3 to save vs horror factor.

Full *robot P.S.* means mega-damage from hand to hand combat. Restrained punch inflicts 1D4 M.D., full strength punch does 2D4 M.D., head butt 1D4 M.D., kick 2D6 M.D., leap kick or power kick 4D6 M.D. (both count as two attacks), and power punch inflicts 3D6 M.D. (counts as two attacks); all plus P.S. damage bonus (M.D.).

Destroyer 'Borg O.C.C.

Alignment: Any

Attribute Requirements: None

O.C.C. Skills:

Language: American (98%)

Language: Dakir Common (98%)

Language: Two of choice (+15%)

Basic and Advanced Math (+15%)

Basic Radio (+15%)

Detect Ambush (+10%)

Pilot: Tank and APC (hover) (+15%)

Sniper

Wilderness Survival (+10%)

Prowl (+15%)

W.P. Energy Rifle

W.P. Assault Rifle

One W.P. of choice

Hand to Hand: Expert

Hand to Hand: Expert can be changed to martial arts or assassin at the cost of one "other" skill.

O.C.C. Related Skills: Select seven other skills. Plus select two skills at level three, two at level five, and one at levels eight, ten, and twelve. All new skills start at first level of proficiency.

Communications: Any (+10%)

Domestic: Any

Electrical: Any

Espionage: Any (+8%)

Mechanical: Any

Medical: Paramedic only (+5%)

Military: Any (+10%)

Physical: Any

Pilot: Any (+10%)

Pilot Related: Any

Rogue: Any (+5%)

Science: Any (+5%)

Technical: Any (+10%)

W.P.: Any

Wilderness: Any (+5%)

Secondary Skills: The character also gets to select five secondary skills. These are additional areas of knowledge that do not get the benefit of the bonus listed in parentheses. All secondary skills start at the base skill level. Also, skills are limited (any, only, none) as previously indicated in the list.

Standard Equipment: ARP-1 plasma rifle or IAR-20 inertia rifle, one energy weapon of choice, 4 E-clips or spare magazines for each, survival knife, field kit, and first-aid kit.

Money: Pay is typically 3000 credits a month plus free room and board, his bionics, equipment, training and access to military facilities. During combat situations, soldiers get a bonus hazard pay of 1000 more credits per month. Starts with one month's pay.

Cybernetics: See above.

Ojahee Cyborg O.C.C.

Unlike the Destroyer 'borg, Ojahee who undergo partial bionic conversion are meant to be used as shock troops — walking tanks with more firepower and armor than most suits of power armor or a giant robot. The O'borgs are the Ojahee's equivalents of armored vehicles. Given their tradition of being infantry fighters first and foremost, they prefer a walking "vehicle" than one of the "alien" tanks humans and other races use. About 5% of all Ojahee warriors undergo full bionic conversion. Ojahee regiments organize them like tanks or robot vehicles.

A huge, armor-plated, twelve foot (8.6 m) tall monstrosity, Ojahee 'borgs have several integral weapon systems thanks to the Dakir's advanced technology. A gatling I-beam gun that can shred a tank with a long burst is housed in a forearm mount. Six mini-missiles are clamped over each shoulder and upper arms. A chest particle beam projector is used to engage foes at short distances. In hand to hand combat, the O'borg can engage enemies with a huge energy axe. Enough of the Ojahee's musculature is left to maintain his supernatural strength, which is augmented through metal reinforcement.

The O'borgs do not have force fields or inertial shields; neither do they have the VR system, because the Ojahee find the whole idea of "virtual reality" offensive and refuse to use it. Their basic systems are somewhat crude compared to those of the Destroyer 'borgs, and have none of their stealth systems, but O'borgs don't need it; they are front-line fighters.

O'borg Abilities and Bonuses:

1. Bionic Reconstruction: The O'borg undergoes partial bionic reconstruction. Most of their flesh and organs are not removed or altered. The bones are reinforced with metal and M.D.C. plating is permanently grafted to the skin. The plating is so thick it adds over a foot in height. The eyes are replaced with multi-optics, and other sensory systems.

M.D.C. by Location: A range of numbers (i.e. 1D4×10+) represents the M.D.C. of the character's living, mega-damage flesh. The fixed numbers represent the combined skeletal reinforcement and body plating.

Hands (2) — 1D4×10+30

Arms (2) — 1D4×10+100

Legs (2) — 1D6×10+120

*Head — P.E. attribute number +100.

* Main Body — P.E. ×3 plus 400; add 8 M.D.C. per level of experience. No extra body armor can be added on/worn.

* Depleting the M.D.C. of the head or the main body will kill the Ojahee.

The bionic reinforcements increase the Ojahee's strength by +6, and it remains supernatural. Unlike a true 'borg, however, the Ojahee gets no bonuses to P.P. or Speed, which remain unchanged (bionic enhancements are canceled out by the extra bulk).

2. Sensory Bonuses: Advanced bionic sensors give the O'borg the equivalent of multi-optic eyes (as per the visors described under the **Megaversal Trooper O.C.C.**), amplified hearing, motion detector, radar detector and personal radar (range: 5 miles/8 km).



3. Weapon Systems: The O'borg is equipped with the following weapon systems:

Gatling I-Gun: This weapon is belt-fed from an ammo compartment on the O'borg's back. Damage: A burst is 10 rounds and does 1D6×10+10 M.D. Can only fire bursts. Range: 1000 feet (305 m). Payload: 1,000 rounds in storage compartment.

Chest Particle Beam Projector: Used for short-range attacks. Damage: 6D6+10 M.D. Range: 500 feet (152 m). Payload: Effectively unlimited.

Energy Axe: This weapon does 4D6 M.D. plus hand to hand damage.

4. Mini-Missile Launchers (2): Each shoulder can launch as many as three mini-missiles at a time.

Primary Purpose: Anti-aircraft

Secondary Purpose: Assault

Mega-Damage: Varies with missile type.

Rate of Fire: One at a time, or in volleys of two, four, or six.

Effective Range: About 1 mile (1.6 km).

Payload: 12 total; 6 per shoulder launch system.

5. Combat Bonuses: The combined cyborg bonuses (includes attribute and R.C.C. bonuses but not skill bonuses) are: an additional attack per melee, +6 to initiative, +2 to parry, +4 to pull punch, +4 to save vs horror factor. Remember, the character has *supernatural* strength and endurance and inflicts mega-damage (see *Rifts Conversion Book One*, page 22).

Ojahee Borg O.C.C.

Alignment: Any

Attribute Requirements: None.

O.C.C. Skills:

Language: Ojahee (98%)

Language: Dakir Common (98%)

Language: One of choice (+15%)

Basic Radio (+15%)

W.P. Energy Rifle

W.P. Axe (treat as W.P. Blunt)

One W.P. of choice

Hand to Hand: Expert

Hand to Hand: Expert can be changed to martial arts or assassin at the cost of one "other" skill.

O.C.C. Related Skills: Select seven other skills. Plus select two skills at level three, two at level five, and one at levels eight, ten, and twelve. All new skills start at first level of proficiency.

Communications: Any (+10%)

Domestic: Any

Electrical: Any

Espionage: Any (+8%)

Mechanical: Any

Medical: Paramedic only (+5%)

Military: Any (+10%)

Physical: Any except prowling (not possible).

Pilot: Any (+10%)

Pilot Related: Any

Rogue: Any (+3%)

Science: Any (+5%)

Technical: Any (+10%)

W.P.: Any

Wilderness: Any (+5%)

Secondary Skills: The character also gets to select five secondary skills. These are additional areas of knowledge that do not get the benefit of the bonus listed in parentheses. All secondary skills start at the base skill level. Also, skills are limited (any, only, none) as previously indicated in the list.

Standard Equipment: See weapon systems, plus an energy weapon of choice and 4 E-clips.

Money: Pay is typically 3000 credits a month plus free room and board, his bionics, equipment, training and access to military facilities. During combat situations, soldiers get a bonus hazard pay of 1000 more credits per month. Starts with one month's pay.

Cybernetics: See above.

Men-Rall

“Tech Master” R.C.C.

The Men-Ralls communicate and manipulate the world via electromagnetic emissions. They cannot talk like humans do, but special translators exist to render their electrical impulses into meaningful speech. Their electromagnetic control allows them to manipulate matter at the molecular level, and they can attack beings with electrical beams. Their expertise is such that they can control, disassemble and repair any piece of machinery, no matter how alien, a power they refer to as “mecha-kinesis.”

The Men-Rall are an old and nearly extinct species. The creatures have revealed very little of their origins, but it is believed that their race once had a thriving culture until an enemy attack or other catastrophe layed waste to their homeworld. The survivors settled in small colonies throughout the Megaverse, where they sold their services as mechanics, tinkers and operators. For some reason, perhaps related to the downfall of their race, the Men-Rall use other races' technology but do *not* invent or create new devices. A rumor links these creatures with the mysterious Machinists, a race that lived in the **Three Galaxies** universe, where they created the Machine People (see *Rifts Dimension Book One: Phase World*).

During the Brodkil Wars that led to the Megaversal Legion's mutiny, several thousand Men-Rall were captured and enslaved by the brodkil and forced to repair their weapons. The Men-Rall were treated with utter contempt and brutality for several years, until the Legion was called in to put a stop to the brodkil's conquest. When Ojahee Commander Okarr subtly explained the Legion's plight to some Men-Rall technicians, the creatures decided to pay back their rescuers by helping them gain their freedom. Using their mecha-kinetic powers, they disarmed the safeguards and booby-traps the Dakir had installed, which, in turn, led to the successful mutiny.

About a thousand of the Men-Rall decided to stay with the Megaversal Legion. Although they do not like fighting and prefer to avoid it, these creatures have served with distinction in the Legion, working mostly as mechanics and engineers, and occasionally lending a hand in combat. Their ability to manipulate and understand machines allowed them to keep the Dakir factories and medical systems operating. Many Men-Rall are now doctors, factory directors and science researchers at Fort Desper-

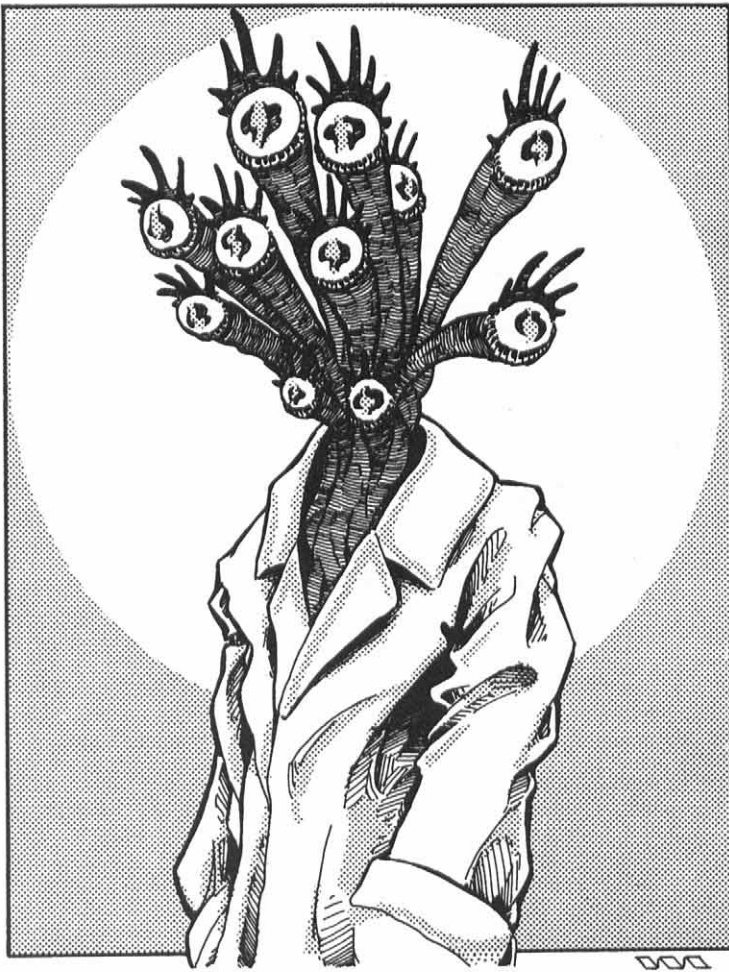

ado. Shortly after their joining the Legion, a human soldier jokingly gave a Men-Rall a human lab coat explaining that the lab coat was, in his words "a ceremonial robe given to our men of science to honor their skills." Since that day, the Men-Rall make and wear similar coats with pride.

Alignment: Any, but lean towards good and selfish.
M.D.C.: 1D4×10. Add 1D6 M.D.C. per level of experience.
Attributes: I.Q. 2D4+18, M.E. 3D6, M.A. 3D6, P.S. 2D6, P.P. 3D6, P.E. 3D6, P.B. 2D4, Spd. 3D4
Size: 5 to 6 feet (1.5 to 1.8 m). **Weight:** 100 to 200 lbs.
Horror Factor: 7
P.P.E.: 3D6
Average Life Span: 300 years
Natural Men-Rall Abilities:

1. Mecha-Kinesis: This power is somewhat similar to the psionic ability of Tele-mechanics (see *Rifts RPG*), although it works through electromagnetism rather than psionics. The Men-Rall can instinctively understand the workings of any machine (88% accuracy); this knowledge becomes permanent after the Men-Rall has been studying the machine for 1D6 hours. By manipulating electromagnetic energy, the character can interact with the machine down to the molecular level, fixing damage at the rate of 3D6 M.D.C. or 1D6×10 S.D.C. per 10 minutes of concentration. The same power can destroy machines at the same rate (this power works too slowly for combat; damage occurs only after ten minutes of concentration have passed, during which time the Men-Rall must be in direct contact with the machine in question). This power does not work on living beings.

2. Electrical Discharges: The Men-Rall can release vast amounts of electrical energy. These attacks can do 1D6 to 1D6×10 S.D.C. (regulated in 1D6 increments), or 2D6 M.D. Add +1D6 M.D. every two levels of experience after the first (i.e., 3D6 M.D. at level three, 4D6 M.D. at level five, etc.). **Range:** 200 feet (61 m).

Experience Level: Varies.

Combat: As per skill.

Damage: As per supernatural P.S.

Bonuses: +1 on initiative, +1 to save vs disease, and +2 to save vs horror factor.

Magic Powers: None.

Psionic Powers: Select six powers from the sensitive, physical or healing categories. Considered a major psionic.

Vulnerabilities/Penalties: None.

R.C.C. Skills:

Three Languages of choice (+20%)

Basic and Advanced Math (+20%)

Two Scientific Skills of choice (+15%)

Two Electrical or Mechanical Skills of choice (+15%)

One W.P. of choice.

Hand to Hand: Basic

Hand to Hand: Basic can be changed to Hand to Hand: Expert at the cost of one "other" skill, or to Martial Arts at the cost of two "other" skills.

R.C.C. Related Skills: Select 10 other skills, but at least 4 have to be in the sciences, electrical, mechanical or medical categories, and all requirements must be filled with related or secondary skills. Plus select two skills at level three, two at level five, and one at levels eight, ten, and twelve. All new skills start at first level of proficiency.

Communications: Any (+10%)

Domestic: Any

Electrical: Any (+15%)

Espionage: None

Mechanical: Any (+15%)

Medical: Any (+10%)

Military: Any (+10%)

Physical: Any except acrobatics

Pilot: Any (+15%)

Pilot Related: Any (+10%)

Rogue: Any

Science: Any (+15%)

Technical: Any (+10%)

W.P.: Any

Wilderness: Any

Secondary Skills: The character also gets to select two secondary skills at levels one, four, eight, and twelve. These are additional areas of knowledge that do not get the benefit of the bonus listed in parentheses. All secondary skills start at the base skill level. Also, skills are limited (any, only, none) as previously indicated in the list.

Alliances and Allies: In addition the Megaversal Legion, the Men-Rall have befriended the inhabitants of New Babylon. A few hundred Men-Rall work in that nation, where they are admired for their skills.

Weapons and Equipment: Energy weapon of choice and 1D4 spare E-clips, hand computer, camera, flashlight, tool kit, and first-aid kit.

Money: 3D6×100 in credits and 2D4×1000 in salable mechanical devices.

Weapons & Equipment of the Legion

Most of the weapons used by the Megaversal Legion are manufactured in Fort Desperado, and use Dakir technology. In their arrogance, the Dakir kept the factories in the same area they kept their soldiers, and the Men-Rall scientists have been able to keep those factories going.

The Dakir had mastered a unique form of force technology they call Inertia Beam or I-Beam technology, which uses a curious energy field that reverses natural physical forces! Instead of slowing down, objects surrounded by I-Beam technology actually gain velocity and momentum as they travel. A bullet that has the normal speed of a 20th Century pistol as it leaves the muzzle will speed up to rail gun velocity after it travels 10 feet (3.0 m), and will continue accelerating for as long as it travels along the path of the I-Beam. Theoretically, such a bullet could travel indefinitely, accelerating until it approached (or maybe even reached) the speed of light! As soon as an object is no longer affected by the I-Beam (surpasses the range limit or the beam is shut off) however, it instantly loses all its momentum and velocity, seemingly stops in mid-air and drops to the ground. The range of I-Beam weapons is limited to the range of the inertia beam projector.

The same technology responsible for I-Beams also creates two kinds of energy fields: *recoil-dampening fields* (also called RD-Fields) and *inertial shields* (I-shields). RD-Fields are used to allow humanoids to fire heavy weapons without suffering the effect of recoil. A human firing a cannon, for example, would normally be smashed into the ground, no matter how strong he was. With the RD-field on, however, the momentum of the gun firing is actually rerouted and refocused forward, increasing the speed of the projectile!

Inertial shield generators are built into the body armor and cyborg frames of all legionnaires. The energy field is powered by an E-clip in the case of body armor or hooked into the power supply of cyborgs and powered armor. The energy field "senses"

incoming physical projectiles (slugs, bullets and missiles) and activates an inertial shield to intercept the object. This works like a parry; the system has a +3 to parry the attack; on a success, the missile loses all forward momentum and falls, inert, to the ground. Even grenades and impact-activated explosives will not go off. If the parry misses, bullets, rail gun slugs and similar attacks will strike, but only inflict half damage as their momentum is reduced but not neutralized by the shield. Explosive force does normal damage and the I-shield cannot stop the force of punches, kicks, hand-held weapons (swords, etc.), which inflict normal damage. Nor has it any effect against energy attacks (lasers, ion, particle beams, plasma, etc.). The shield can only stop a certain amount of attacks every round (typically 1-3). See individual armor descriptions for more information.

Other Weapons: In addition to the weapons described in the following section, the Legion has purchased a number of Naruni Enterprises hand weapons. Since the Dakir did not manufacture robots, a number of Naruni robots and a hundred tanks and APCs have been purchased to equip the growing army. Refer to *Rifts Mercenaries* and *Rifts Dimension Book Two: Phase World* for more information about the Naruni and other mercenary groups. Additionally, a few weapon systems developed in New Babylon have also been purchased to supplement the ones produced locally.

Note: Weapons and equipment that use Dakir technology are *NEVER* sold, traded, or abandoned outside the Megaversal Legion! In fact, the Legionnaires will confiscate or go after any Dakir weapon or item that falls into an adventurer's, or worse yet, an enemy's hands. The ammo and I-Beam technology can only be found in the automated factories of Fort Desperado (and the worlds controlled by the Dakir in other parts of the Megaverse). The Coalitions States, Triax, Northern Gun, Naruni, the Splugorth and others would pay a fortune to acquire this technology if they realized it existed.

IAR-20 Inertia Rifle

This unusual weapon uses the unique Dakir Inertia Beam technology to eliminate recoil and fire an accelerated 7mm rifle round at incredible speed. This is the most common rifle among the humanoid members of the Legion; about 60% of all human-sized line infantrymen use this weapon; 30% rely on the ARP-1, described below, and the remainder use specialized rifles.

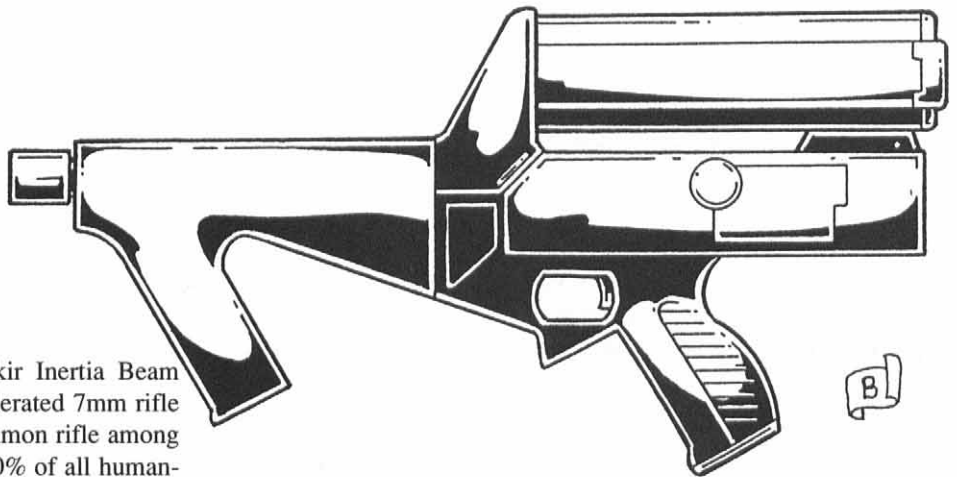

The IAR-20 is light and compact, with a folding stock, a short barrel, more appropriate for a carbine than a rifle, and a round magazine located on top of the gun, somewhat similar to the 20th Century Calico sub-machinegun. The gun's small size and light weight allow it to be used by tank crews, pilots and support personnel in addition to line soldiers. About 20% of these rifles (the IAR-20G) have an attached grenade launcher with a shotgun-like, tubular magazine that holds seven grenades.

Weight: 6 lbs. (2.7 kg)

Mega-Damage: 2D6 M.D. per single shot, burst of 15 rounds does 1D4×10 M.D., a long burst is 30 rounds and does 2D4×10+10 M.D. The IAR-20G grenades do 3D6 M.D. to a 20 feet (6.1 m) blast radius.

Rate of Fire: Single shots, or bursts of 15 or 30 rounds. Single shot only with the grenade launcher.

Effective Range: 3000 feet (914 m) for both the bullets and the grenades.

Payload: 90 shot magazine; the grenade launcher can hold up to seven grenades.

Cost: Not for sale outside the Megaversal Legion.



IAR-2 Auto-Pistol

This hand weapon is used by officers and pilots, as well as a back-up for line soldiers. It uses the same I-Beam technology to propel rounds at great speeds as the IAR-20 rifle. The pistol has a cylindrical magazine on top of the receiver.

Rate of Fire: Standard.

Weight: 3 lbs. (1.35 kg)

Effective Range: 1000 feet (305 m)

Mega-Damage: 3D6 M.D.

Payload: 20 rounds

Cost: Not for sale outside the Megaversal Legion.

HIAR-22 Heavy I-Beam Rifle

This is the Ojahee version of the IAR-20 Rifle. Like the HRP-1, this rifle also has an axe attachment. Damage and range are the same, but the HIAR-22 has an oversized magazine for extra ammunition.

Weight: 24 lbs. (10.9 kg)

Mega-Damage: 2D6 M.D. per shot, burst of 15 rounds does 1D4×10 M.D., long burst is 30 rounds and does 2D4×10+10 M.D.

Vibro-Axe: 3D6 M.D. plus supernatural P.S. damage.

Rate of Fire: Single shots, or bursts of 15 or 30 rounds.

Effective Range: 3000 feet (914 m).

Payload: 150 shot oversized magazine.

Cost: Not for sale outside the Megaversal Legion.

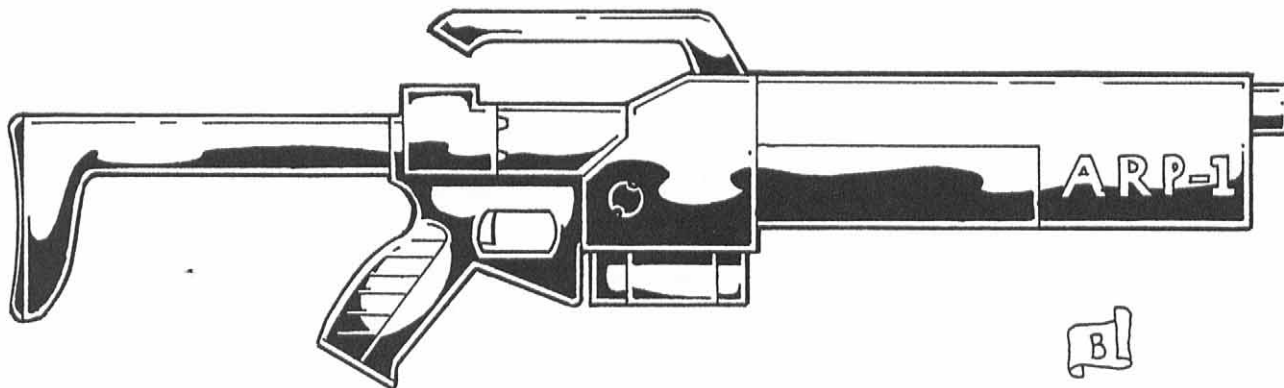

ARP-1 Plasma Assault Rifle

The ARP-1 is a light but powerful rifle that fires thin plasma discharges. The weapon is designed for human-sized users, and is very easy to use and carry. The high rate of fire provided by this rifle allows for *aimed bursts*. Concentrated fire from several ARP-1 rifles can melt down most M.D.C. vehicles. The gun is slightly heavier and larger than the IAR-20, and its use is limited to line infantrymen. In operations against the Arkhons, the rifle has proved to be less efficient.

Weight: 8 lbs. (3.6 kg)

Mega-Damage: 3D6+4 M.D. per shot; three round burst does 1D6×10+10 M.D.

Rate of Fire: Single shot or three round burst only. No recoil, so it can fire *aimed bursts* at +3 to strike.

Effective Range: 2000 feet (610 m).

Payload: 30 shots

Cost: Not for sale outside the Megaversal Legion.

HRP-1 Plasma Heavy Rifle

Designed for the Ojahee warriors, the HRP-1 is a long, heavy rifle that fires an extra-heavy plasma discharge. The gun is built along the same lines as a musket to ease the Ojahee into using this advanced weapon. The rifle even has a vibro-axe attachment, just like the traditional Ojahee musketoons.

Weight: 30 lbs. (13.5 kg)

Mega-Damage: Plasma: 1D6×10+10 M.D. per blast. Vibro-Axe: 3D6 M.D. plus supernatural P.S. damage.

Rate of Fire: Single shot only.

Effective Range: 3000 feet (914 m)

Payload: 20 shots per E-Clip.

Cost: Not for sale outside the Megaversal Legion.

H-11A Howitzer

The H-11A is a hand cannon, a 75mm howitzer configured as a giant rifle. Ordinarily, such a weapon has such tremendous recoil that no biped, even a cyborg, could fire it from a standing position (and very few beings could shoot it from a crouch, either). However, the science of the Dakir has found a way around this problem through the use of recoil-dampening fields, or RD-fields. These energy fields somehow channel and deflect the incredible recoil this weapon produces. The RD-field is invisible, so their only effect is the fact that a normal human can fire a cannon-like weapon without any more difficulty than shooting a heavy rifle.

The howitzer fires a number of projectiles. Unlike 20th Century cannon shells, the H-11As ammunition is light and compact while packing even more explosive power. Each shell is roughly 3 inches (75mm) thick and 5 inches (13cm) long. The fin-stabilized rounds can be used for direct fire (like a rifle) or indirect bombardment (like a mortar). Even with the RD-System, this hand cannon is so heavy that only humans with a P.S. of 24 or higher can use it effectively. Humans with a P.S. of 19-23 fire at -2 to strike, those with a P.S. of 16-18 fire at -4, and weaker humans simply cannot use it unless they are wearing power armor.

The cannon looks like an oversized rifle with a huge revolver cylinder that holds 10 shells. The cylinder can be reloaded by hand or replaced by a new one. The gun is attached to the wearer by a harness that makes it easier to handle (without the harness, the penalties are doubled).

Weight: 120 lbs. (54 kg)

Mega-Damage: High Explosive: 1D6×10 M.D. to a 40 foot (12.2 m) radius. Anti-Armor: 2D4×10 to a 3 foot (0.9 m) radius. Fragmentary: 4D6 M.D. to a 100 foot (30.5 m) radius.

Rate of Fire: Each shot counts as one hand to hand attack. Fragmentary and High-Explosive rounds can be fired in a high arc; the rounds are "smart" and will home in on any enemies within a 500 foot (152 m) radius of its arc of descent. The bomb is at +2 to strike as it falls.

Effective Range: 2000 feet (610 m) direct fire, or 2 miles (3.2 km) indirect fire.

Payload: 10 round drum.

Cost: Not for sale.

Armor & Power Armor

Mark I Body Armor

The Mark I Armor is designed for humans and humanoid beings. The Legion's body armor consists of a breast plate and articulated plates for the legs and arms. The helmet has an open "T" slit, with enough room to fit the grafted visor most ML troopers wear. A transparent, glass-like M.D.C. material covers the slits, making the armor airtight despite the illusion of openness. This armor has a built in inertial shield for added protection. This energy shield is an invisible aura around the armor that "flares" up when a rapidly moving physical object (such as a bullet) enters the field.

- 90 M.D.C.
- Weight: 20 lbs. (9 kg)
- Inertial Shield: Will try to stop incoming physical attacks (includes bullets, missiles and rail guns, but not energy weapons, punches and hand to hand attacks). The shield automatically parries at +3 (automated, does not use the wearer's attacks, nor his bonuses). If the parry is successful, the bullet or missile falls to the ground, inert and harmless (no damage). Even if the parry fails and the round strikes, the wearer only takes half damage. The shield can only parry three projectiles per round.
- Good Mobility: -5% prowl penalty.
- Not for sale.

Mark II Body Armor

This body armor suit is essentially identical to the Mark I armor, but is designed to fit large-sized humanoids, the Ojahee in particular. Thus, the armor is heavier and has greater penalties unless the person is strong enough to carry its weight (P.S. 24 or higher). Designed for large humanoids (7 feet tall or taller).

- 150 M.D.C.
- Weight: 50 lbs. (25 kg)
- Inertial Shield: Standard; same as the Mark I armor.
- Good Mobility for strong, large humanoids: -5% prowl penalty. However, the minimum strength required to carry the armor efficiently is 24 (16 if supernatural P.S.). If strength is less than that, the wearer has a -15% prowl penalty, speed is reduced by half, and all attack actions are at -1.
- Not for sale.

Counterstrike Power Armor

The Counterstrike is the primary power armor of the Legion. This large power armor can participate in many different missions, from infantry to air attacks. On the borderline between power armor and robot, the Counterstrike has a humanoid frame that resembles a suit of medieval armor. The helmet/head has a spike in the center, reminiscent of a World War I Austrian helmet. The suit flies through a contra-gravity/inertia beam system that allows it to fly at great speeds and maneuver with great ease. Theoretically, the I-Beam propulsion system could allow



the suit to fly at even higher speeds, but the Dakir purposely limited its maximum speed to make it less dangerous to use. So far, not even the Men-Rall engineers have been able to overcome this limitation.

Side wings also act like missile launchers; they have nothing to do with the flight system, and destroying them has no effect. Other armament includes an I-Beam gatling gun mounted on the right forearm, a plasma blaster on the left forearm, and two chest lasers. Retractable, double wrist energy blades can jump into place whenever the power armor enters close combat. Finally, two grenade launchers are mounted over the shoulders of the power armor. With this variety of weapon systems, the Counterstrike can engage in aerial dogfights, bomb and strafe infantry formations, and take on tanks, robots and powered armor.

Counterstrike platoons (10 to 20 soldiers) are often sent ahead on reconnaissance missions, sometimes supported by 1-4 Neo-Apache Attack Helicopters. This power armor has proved to be the match of both the Arkhons' and Silver River Republics' equivalents. Among other things, the Counterstrike has an I-Shield system that provides protection from most non-energy attacks. Coupled with its mobility and firepower, this suit has won the upper hand for the Legion in hundreds of battles against enemies as diverse as the Splugorth, Naruni-equipped mercenaries, and dozens of others.

Model Type: APA-100

Class: Air-Land Assault Exoskeleton

Crew: One

M.D.C. by Location:

Wings/Missile Launchers (2) — 100 each

* Hands (2) — 90 each

Arms (2) — 200 each

Legs (2) — 300 each

* Retractable Vibro-Blades (2) — 30 each

* Shoulder Grenade Launchers (2) — 40 each

** Head — 180

*** Main Body — 550

* Denotes a small and difficult target to hit, requiring a called shot at -4 to strike.

** Destroying the head destroys all forms of optical enhancement and sensory systems. The pilot must now rely on his own vision and senses. No power armor combat bonuses to strike, parry and dodge! The head is a small and difficult target to hit. It requires a called shot and even then the attacker is -4 to strike.

*** Depleting the M.D.C. of the main body destroys the armor, rendering it useless.

Speed

Running: 100 mph (160 kmph)

Flying: 600 mph (960 kmph) maximum.

Range: Unlimited; the I-Beam system does not require rest stops; the armor's range is limited only by the endurance of the pilot. Maximum altitude is an unbelievable 40,000 feet (12,192 m).

Statistical Data

Height: 10 feet (3.0 m)

Width: 7 feet (2.1 m); 9 feet (2.4 m) with the side wings/missile launchers.

Length: 4 feet (1.2 m)

Weight: 1 ton

Physical Strength: Equal to a P.S. 40.

Cargo: None.

Power System: Anti-matter; average energy life 30 years.

Market Cost: Not for sale.

Weapon Systems

1. I-Beam Gatling Gun: Mounted on the right hand, this heavy gun fires inertia-accelerated bullets at high speeds.

Primary Purpose: Anti-armor

Secondary Purpose: Defense

Mega-Damage: A burst is 20 rounds and does 2D6×10 M.D. Can only fire bursts.

Rate of Fire: Equal to the number of hand to hand attacks of the pilot.

Effective Range: 3000 feet (914 m)

Payload: 2000 rounds in storage compartment.

2. Plasma Blaster: A heavy plasma blaster is mounted on the other forearm, and is used mainly against enemy vehicles.

Primary Purpose: Anti-armor

Secondary Purpose: Defense

Mega-Damage: 1D6×10 M.D. per blast.

Rate of Fire: Equal to the number of hand to hand attacks of the pilot.

Effective Range: 2000 feet (610 m)

Payload: Effectively unlimited.

3. Mini-Missile Launchers (2): Two sets of 8 mini-missiles are in double rows beneath the wings.

Primary Purpose: Anti-aircraft

Secondary Purpose: Defense

Mega-Damage: Varies with missile type.

Rate of Fire: One at a time, or in volleys of two, four, six, eight or sixteen missiles.

Effective Range: About 1 mile (1.6 km).

Payload: 16 total; 8 per launcher.

4. Torso Lasers (2): These light lasers are used to engage infantry at close range or to detonate enemy missiles.

Primary Purpose: Anti-personnel

Secondary Purpose: Defense

Mega-Damage: 2D6 M.D. per laser, or simultaneous double laser blast does 4D6 M.D.

Rate of Fire: Equal to the number of hand to hand attacks of the pilot.

Effective Range: 2000 feet (610 m)

Payload: Effectively unlimited.

5. Grenade Launchers (2): Two rapid-firing grenades, fed from a back-mounted magazine, allow the Counterstrike to saturate an area with grenades. The standard issue of this weapon are fragmentation grenades. The grenades can also be primed to explode in the air, which makes them useful against aircraft and enemy missiles. The launchers can fire single shots or full automatic bursts.

Primary Purpose: Anti-personnel

Secondary Purpose: Defense, anti-aircraft.

Mega-Damage: Each grenade does 3D6 M.D. to a 30 foot (9.1 m) area. A burst of three grenades does 3D6+6 M.D. to a 60 foot (18.3 m) area. A long-burst (10 grenades; counts as two melee attacks) does 4D6+6 M.D. to a 100 foot (30.5 m) area.

Rate of Fire: Single shots, or bursts of 3 or 10 grenades.

Effective Range: 4000 feet (1220 m)

Payload: 60 total; 30 per launcher.

6. Double Wrist Blades: Two blades can spring forward from each side of the wrists of the power armor. When energized, the blades can slash through M.D.C. materials with ease.

Primary Purpose: Assault.

Mega-Damage: 4D6 M.D. per slash.

Rate of Fire: Equal to the number of hand to hand attacks.

Effective Range: Hand to hand.

7. Hand to Hand Combat: Rather than use a weapon, the pilot can engage in mega-damage hand to hand combat.

Power Armor Bonuses:

+1 attack per melee at levels one, six and twelve; in addition to those of the pilot.

+1 to dodge at levels one, four and eight.

+2 to roll with punch, fall or impact.

+2 to pull punch.

Critical strike, same as the pilot's.

Mega-Damage:

Restrained Punch: One M.D.

Full Strength Punch or Kick: 1D6 M.D.

Power Punch or Leap Kick: 3D6 M.D. (counts as two melee attacks)

Legion Vehicles

Neo-Abrams M10A1

Main Battle Tank

The U.S. 7th Cavalry, kidnapped from Earth by the Dakir, were trained to use M1A3 Abrams battle tanks, the most advanced tank ever built in the 20th Century. To facilitate the transition for their warrior-slaves, the Dakir based their new tank design on this respectable vehicle. The result was a tank that combined the best aspects of the M1 with the ultra-technology of the alien slavers. The M10A1 is a powerful, well armed and armored war machine that can match even the dreaded Naruni Juggernaut (see *Rifts Mercenaries*). The Megaversal Legion is feared mostly for their tanks. Even the Arkhon warriors feel it's no dishonor to flee from a company of these land leviathans.

The basic shape of the M-1 tank has been kept in the turret and its gun. The M-1's 120mm gun now fires I-Beam projectiles, accelerated to incredible speeds. This cannon has a good chance of getting a one-shot kill on many armored vehicles and robots, and few targets can survive more than three shots. The preferred anti-tank round is a solid sabot round, a metal dart flying at a good approximation to the speed of light! High explosive and canister rounds are used against "softer" targets. The tank is auto-loading, eliminating the need of a loader, who has now been replaced by a second gunner. A coaxial grenade launcher is housed to the left of the main gun and used to combat infantrymen.

The main body of the tank vaguely resembles that of the original, but the tracks have been replaced by a hovercraft propulsion system that can propel the tank at speeds of up to 300 mph (480 kmph). An inertia field allows the tank to make 45-degree turns without losing any speed, and even 90-degree turns at speeds of over 100 mph (160 kmph)! Two additional weapon systems have been built onto the main body, to be used by the secondary gunner and the driver. The first one consists of two medium-range missile launchers on the sides of the main body. These launchers give the tank the ability to place 20 missiles up to 80 miles (128 km) away! A bow-mounted plasma machinegun is used to engage infantrymen at close range. The missiles or the plasma machinegun on a top cupola can be used by the tank commander.

In addition to the strongest M.D.C. materials available used to make the thick plates of the tank, it is protected by a force field. An inertial shield was considered but then discarded; the tank's motions tended to activate the shield at the wrong times, leading to control failures. Besides, the tank is as heavily armored as any vehicle can be; one of the advantages of tank de-

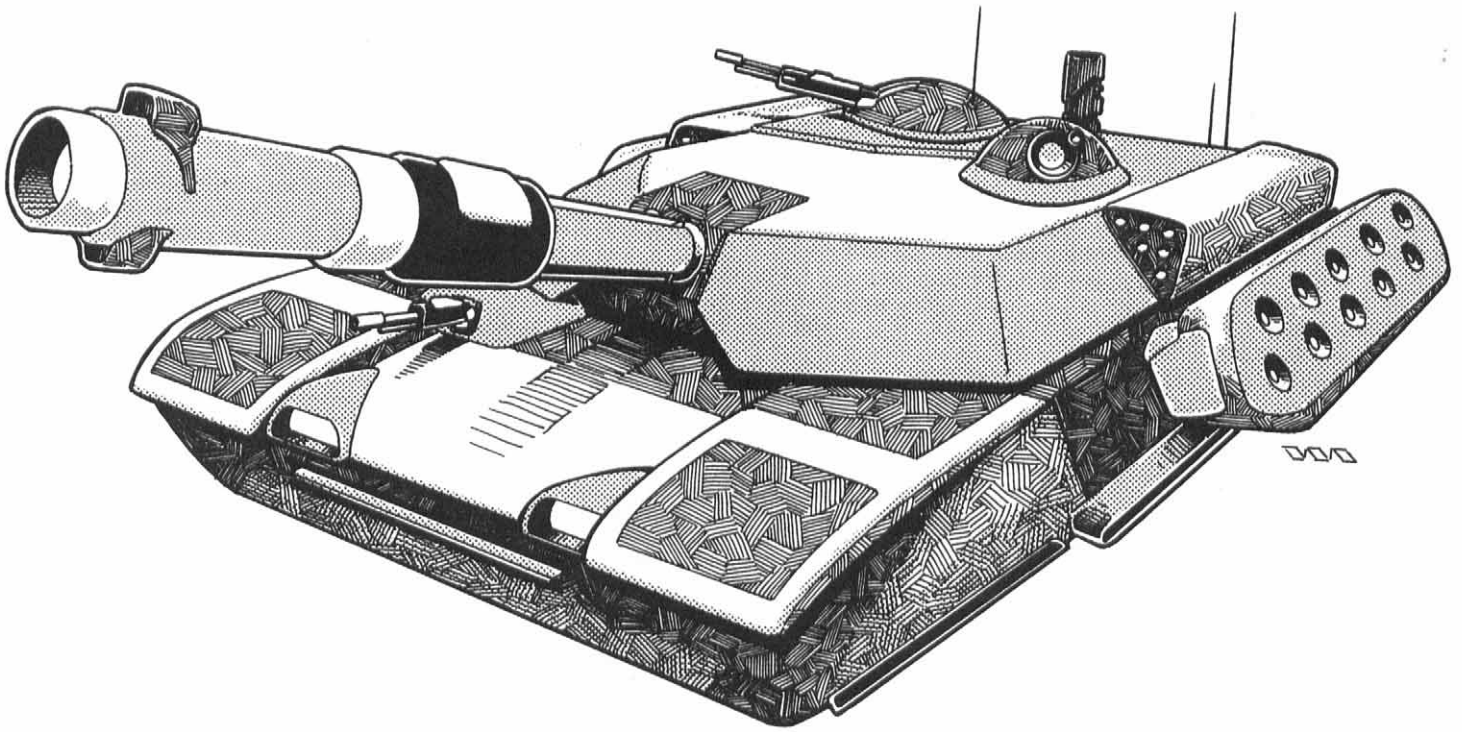

signs over robots is that a relatively small area needs to be protected, allowing for thicker armor to protect the entire area.

These tanks form the main strike force of the Legion. A squad of three or four tanks can advance despite enemy resistance; typically, one or two tanks move forward while the rest fire from cover. Very few small units will stand up to the punishment this combat vehicle can inflict at short or long distances. The speed of the M-10 is also a factor; even at cruising speeds, the tanks can cover 1-2 miles (1.6-3.2 km) in a minute! That gives the enemy precious little time to destroy the incoming tanks before they are on top of them. The Arkhon "Porcupines" can only match M-10s if they outnumber the legionnaires five or six to one, and even in some skirmishes this numerical advantage is not enough.

Model Type: MBT-10A1

Class: Main Battle Tank

Crew: Four; commander, pilot and two gunners.

M.D.C. by Location:

* Turret — 550 -

120mm I-Cannon in Turret — 200

Coaxial Grenade Launcher — 80

Mini-Missile Launchers (2, in turret sides) — 60 each

Plasma Machinegun in Cupola — 120

** Fan Skirts — 400

Bow-Mounted Plasma Gun — 120

Medium-Range Missile Launchers (2, on main body sides) — 120 each

Reinforced Crew Compartment — 150

*** Main Body — 850

Force Field — 450

* Depleting the M.D.C. of the turret tears it off the vehicle, rendering all weapons in it useless. Targeting the turret requires a called shot at no further penalty.

** Destroying the fan skirts will destroy the hovercraft system, grounding the vehicle and rendering it immobile. Field repairs will take 1D6 hours (and there is a 1-40% chance the tank cannot be repaired in the field).

*** Depleting the M.D.C. of the main body destroys the vehicle, rendering it useless.

Speed

Driving on the ground: The hovercraft system can propel the vehicle to an incredible speed of 300 mph (480 kmph)! A low-grade inertial field allows the tank to maneuver even at these incredible speeds.

Flying: Not possible. The hovercraft system can lift the tank to a maximum height of 7 feet (2.1 m) above a surface before losing pressure and causing the tank to sink down. The Neo-Abrams can travel over swamps and mud, but cannot travel over water deeper than 5 feet (1.5 m) or it will sink.

Statistical Data

Height: 14 feet (4.25 m)

Width: 18 feet (5.4 m)

Length: 36 feet (10.9 m)

Weight: 160 tons

Cargo: A storage space for the crew, large enough for clothing and personal effects, and a weapons locker that holds four rifles, 16 E-Clips (or clips) and 20 grenades.

Power System: Antimatter; average energy life of 30 years.

Market Cost: Not for sale. Some nations would pay over 200 million for a new, undamaged tank; so far, no tanks have been captured.

Weapon Systems

1. 120mm I-Beam Cannon: This cannon uses the same I-Beam technology that propels rifle bullets at incredible velocities. The beam does the same thing to tank rounds. The three main types of ammo used in the Neo-Abrams include an armor piercing solid round, basically a metal dart traveling at 1,000 miles (1600 km) per second! This round will rupture most armor plating (Note: AP rounds are only used against tanks, APCs and large robots; it would almost never be used against infantry — too wasteful). Conventional high explosive (roughly with the same exploding power as a long-range missile) and canister (a giant shotgun load, thousands of metal balls flying from the barrel) are used against buildings and in-

fantry. The tank has a 60-round magazine with three sub-compartments; typically it carries 20 rounds of each ammo type.

Primary Purpose: Anti-armor.

Secondary Purpose: Anti-personnel (canister)

Mega-Damage: AP Round: 5D6×10 M.D.; High Explosive: 3D6×10 M.D. to a 50 foot (15.2 m) radius. Canister: 1D4×10 M.D. to all targets in a 60 foot (18.3 m) cone!

Rate of Fire: Three times per melee round maximum (or number of hand to hand attacks of the pilot, whichever is less).

Effective Range: 11,000 feet (about two miles/3.2 km) for AP and HE rounds; 1000 feet (305 m) for canister.

Payload: 60 rounds.

2. Coaxial Grenade Launcher: These grenades are I-Beam powered, and the gunner can actually have them drop on a target by illuminating the target with a laser-aiming point. A common tactic to deal with entrenched infantry is to drop a burst of grenades on them, flushing them out — right in time for a canister round. The grenades can be detonated in the air, making them a decent substitute for anti-aircraft and anti-missile “flak.”

Primary Purpose: Anti-personnel

Secondary Purpose: Defense

Mega-Damage: Each grenade does 3D6 M.D. to a 30 foot (9.1 m) area. A burst of three grenades does 3D6+6 M.D. to a 60 foot (18.3 m) area. A long burst (10 grenades; counts as two melee attacks) does 4D6+6 M.D. to a 100 foot (30.5 m) area.

Rate of Fire: Single shots, or bursts of 3 or 10 grenades.

Effective Range: 4000 feet (1220 m)

Payload: 120 total.

3. Plasma Machinegun (Cupola): This plasma gun fires quick bursts of super-hot plasma. In addition to its damage, the plasma beams will ignite any flammable materials within 20 feet (6.1 m) of its beam.

Primary Purpose: Anti-personnel

Secondary Purpose: Defense

Mega-Damage: 1D6×10 M.D. per burst. Can only fire bursts.

Rate of Fire: Equal to the number of hand to hand attacks of the gunner.

Effective Range: 2000 feet (610 m)

Payload: Effectively unlimited.

4. Mini-Missile Launchers (2): These 8-shot missile boxes allow the tank to engage low-flying aircraft, as well as act as an anti-missile defense system.

Primary Purpose: Anti-aircraft

Secondary Purpose: Defense

Mega-Damage: Varies with missile type.

Rate of Fire: One at a time, or in volleys of two, four, eight and sixteen missiles.

Effective Range: About one mile (1.6 km).

Payload: Sixteen total, eight per launcher.

5. Bow-Mounted Plasma Machinegun: Essentially the same weapon as the cupola gun; used by the secondary gunner or the pilot to take out any infantrymen who are close up, or enemy vehicles in range.

Primary Purpose: Anti-personnel

Secondary Purpose: Defense

Mega-Damage: 1D6×10 M.D. per burst. Can only fire bursts.

Rate of Fire: Equal to the number of hand to hand attacks of the gunner.

Effective Range: 2000 feet (610 m)

Payload: Effectively unlimited.

6. Medium-Range Missile Launchers: Two 10 missile boxes on the sides of the tank give the Neo-Abrams the capability to attack targets dozens of miles away. For the enemies of the Megaversal Legion, a massive volley of 80 missiles often heralds an attack by a Neo-Abrams tank platoon — a platoon that is probably only a few minutes away.

Primary Purpose: Long-range bombardment.

Secondary Purpose: Anti-aircraft

Mega-Damage: Varies with missile type.

Rate of Fire: One at a time, or in volleys of two, four, six, eight, ten or twenty missiles.

Effective Range: 40 to 80 miles (64 to 128 km)

Payload: 20 total; 10 per missile launcher.

7. Force Field: An energy field can be activated to protect the tank. The force field “regenerates” damage at the rate of 10 M.D.C. per minute (4 melee rounds); if the field’s M.D.C. is depleted, it shorts out and cannot be redeployed for four hours.

8. Sensors, etc.: The tank has all the same basic sensors, communications, and environmental features as most giant robots.

Neo-Bradley M6 IFV Scout Vehicle

Like the M10A1, the Neo-Bradley is a hybrid of human designs and alien technology. The result is a larger, more heavily armored vehicle, bristling with weapons. The APC used to ferry a 10 man human-sized squad, or a smaller squad of 6 Ojahee warriors, through the nastiest battlefields. This vehicle uses a hovercraft system and like its companion tank, can maneuver over any solid surface without losing any speed or maneuverability. The main turret is a quick-firing plasma cannon, supported by a coaxial grenade launcher. Two medium-range missile launchers give mechanized platoons the same artillery capabilities of the M-10 tank. A scout version of this vehicle has slightly heavier armor but only capacity for two soldiers.

Model Type: M6-IFV, or M6S-IFV

Class: Infantry Fighting Vehicle.

Crew: Two; a gunner and a pilot.

Troop Capacity: 10 human-sized soldiers in body armor, or 6 Ojahee soldiers or power armor troopers. Scout version only has room for two humans or 1 Ojahee or power armor trooper.

M.D.C. by Location:

* Turret — 200

Plasma Cannon in Turret — 100

** Fan Skirts — 200

Medium-Range Missile Launchers (2, on sides) — 120 each

*** Main Body — 450

Force Field — 200

* Depleting the M.D.C. of the turret tears it off the vehicle, rendering all weapons in it useless. Targeting the turret requires a called shot at no further penalty.

** Destroying the fan skirts will destroy the hovercraft system, grounding the vehicle and rendering it immobile. Field repairs will take 1D6 hours (and there is a 1-40% chance the tank cannot be repaired in the field).

*** Depleting the M.D.C. of the main body destroys the vehicle, rendering it useless.

Speed

Driving on the ground: The hovercraft system can propel the vehicle to an incredible speed of 300 mph (480 kmph). A low-grade inertial field allows the tank to maneuver even at these incredible speeds.

Flying: Not possible. The hovercraft system can lift the tank to a maximum height of 7 feet (2.1 m) above a surface before losing pressure and causing the APC to sink down. The Neo-Bradley can travel over swamps, mud, and even rivers or lakes, but only at high speeds (100 mph/160 km or greater) or it will sink. The APC will also sink if it travels more than a mile over water.

Statistical Data

Height: 12 feet (3.65 m)

Width: 14 feet (4.25 m)

Length: 30 feet (9.1 m)

Weight: 60 tons

Cargo: In addition to the troop compartment, the vehicle has a weapons locker with 8 rifles, 40 E-Clips and 40 grenades.

Power System: Anti-matter; average energy life of 30 years.

Market Cost: Not for sale. Some nations would pay over 100 million for a new, undamaged vehicle; so far, no Neo-Bradleys have been captured.

Weapon Systems

1. Plasma Cannon: A light plasma cannon is the main gun of the Bradley.

Primary Purpose: Anti-armor

Secondary Purpose: Defense

Mega-Damage: 2D4×10 M.D. per blast.

Rate of Fire: Equal to the number of combined hand to hand attacks of the gunner.

Effective Range: 4000 feet (1220 m)

Payload: Effectively unlimited.

2. Coaxial Grenade Launcher: These grenades are I-Beam powered, and the gunner can actually have them drop on a target by illuminating the target with a laser-aiming point.

Primary Purpose: Anti-personnel

Secondary Purpose: Defense

Mega-Damage: Each grenade does 3D6 M.D. to a 30 foot (9.1 m) area. A burst of three grenades does 3D6+6 M.D. to a 60 foot (18.3 m) area. A long burst (10 grenades; counts as two melee attacks) does 4D6+6 M.D. to a 100 foot (30.5 m) area.

Rate of Fire: Single shots, or bursts of 3 or 10 grenades.

Effective Range: 4000 feet (1220 m)

Payload: 120

3. Medium-Range Missile Launchers: Two 10-missile boxes on the sides of the vehicle allow the Bradley to fire at faraway targets.

Primary Purpose: Long-range bombardment.

Secondary Purpose: Anti-aircraft

Mega-Damage: Varies with missile type.

Rate of Fire: One at a time, or in volleys of two, four, six, eight, ten or twenty missiles.

Effective Range: 40 to 80 miles (64 to 128 km)

Payload: 20 total; 10 per missile.

4. Force Field: An energy field can be activated to protect the IFV. The force field “regenerates” damage at the rate of 10 M.D.C. per minute (4 melee rounds); if the field’s M.D.C. is depleted, it shorts out and cannot be redeployed for four hours.

5. Sensors, etc.: The armored personnel carrier (APC) has all the same basic sensors, communications, and environmental features as most giant robots.

Neo-Apache

AH-50 Attack Aerodyne

The Dakir consider helicopters to be primitive machines, so when training the crews of the Apache helicopter gunships, they switched to a contragravity flier that has no vulnerable rotors to target and destroy. The Neo-Apache still shares many similarities with the original 20th century war machine. It has a dragonfly-like shape, is fast and maneuverable, and is heavily armored and armed — nothing short of a flying tank. The Neo-Apache doubles as both a gunship and a fighter, able to fly at speeds of Mach 3 and engage enemy aircraft with the same ease as it destroys ground vehicles.

This aerodyne has a nose gatling plasma cannon and no less than five missile launchers under its “wings” and underside, firing a mixture of long, medium-range and mini-missiles. Additionally, the gunship has two I-Beam machineguns mounted on the sides. Its contragravity/inertial beam propulsion system allows the ship to maneuver even at very high speeds. A light force field offers some additional measure of protection.

Neo-Apache patrols maintain a constant watch over the Andean skyline, alert for Arkhon attacks and other threats. Dog-fights between the Arkhon “Spikefish” fighters and the Neo-Apaches will sometimes light up the night sky. For the most part, however, the Arkhons have learned to respect the Megaversal Legion’s “no fly zone” around their territory — at least until the aliens decide to mount a major assault.

Model Type: NAH-50

Class: Gunship/Air Superiority Fighter.

Crew: Four; pilot, co-pilot/gunner, sensor operator and secondary gunner.

M.D.C. by Location:

Long-Range Missile Launchers (2, underside) — 100

Nose Gatling Plasma Gun — 120

Wings (2) — 120 each

Mini-Missile Launchers (2, under wings) — 50 each

Medium-Range Missile Launchers (2, under wings) — 100 each

I-Beam Machineguns (2, on wing extremes) — 90 each

* Main Body — 400

Reinforced Pilot’s Compartment — 150

Force Field — 160

* Depleting the M.D.C. of the main body causes the vehicle to crash unless the pilot makes a skill roll at -35%.

Speed

Driving on the ground: Not possible.

Flying: Mach 3 (2010 mph/3234 kmph) maximum. When attacking ground targets, speeds rarely exceeds 100 mph (160 kmph).

Range: Unlimited; does not need cooling off periods. The only limitation is the pilot’s endurance (needs to sleep, eat, etc.). With the pilot and auto-pilot taking turns, the ship could fly indefinitely. Maximum altitude is an astounding 30,000 feet (9144 m).

Statistical Data

Height: 12 feet (3.65 m)

Width: 8 feet (2.4 m)

Length: 35 feet (11 m)

Weight: 8 tons

Cargo: Small compartment for personal effects and a weapons locker with four energy rifles, 12 E-Clips (or clips), and 20 grenades.

Power System: Antimatter; average energy life of 30 years.

Market Cost: Not for sale.

Weapon Systems

1. Gatling Plasma Gun: This four-barreled gun fires fast concentrated bursts of energy. Not even tanks can withstand the punishment the guns inflict for long.

Primary Purpose: Anti-armor

Secondary Purpose: Defense

Mega-Damage: 3D4×10 M.D. per burst. Can only fire bursts.

Rate of Fire: Equal to the number of hand to hand attacks of the pilot.

Effective Range: 4000 feet (1220 m)

Payload: Effectively unlimited.

2. Long-Range Missile Launcher: These launchers hold three missiles each. They are used either to engage enemy tanks at point-blank range or to strike enemy installations (radar centers, military bases, etc.) at a distance.

Primary Purpose: Anti-armor and bombardment.

Secondary Purpose: Anti-aircraft

Mega-Damage: Varies with missile type.

Rate of Fire: One at a time, or volleys of two or three.

Effective Range: Varies with missile type.

Payload: Six; three missiles per launcher.

3. Mini-Missile Launchers (2): These missiles can be fired in a spread pattern to cover a large area, or concentrated on a single target. The first mode uses fragmentation missiles against concentrated infantry or light vehicles; the entire area is saturated and everybody in it takes damage. The second mode uses armor-piercing missiles against tanks, robots and other "hard" targets.

Primary Purpose: Anti-personnel and anti-armor.

Secondary Purpose: Defense

Mega-Damage: Fragmentation: 5D6 M.D. to a 20 foot (6.1 m) radius. Each missile raises the area affected by 10 feet (3.0 m).

Armor-Piercing: 1D4×10 M.D. per missile.

Rate of Fire: One at a time, or in volleys of two, four, eight, sixteen or thirty-two missiles.

Effective Range: About one mile (1.6 km).

Payload: 32 total; 16 per launcher.

4. Medium-Range Missile Launchers (2): Two four-missile launchers are near the end of the wings. They add firepower and can be used for the same missions as long-range missiles.

Primary Purpose: Anti-armor and bombardment.

Secondary Purpose: Defense

Mega-Damage: Varies with missile type.

Rate of Fire: One at a time, or in volleys of two, four or eight missiles.

Effective Range: 40 to 80 miles (64 to 128 km)

Payload: 8 total, 4 per launcher.

5. I-Beam Machineguns (2): These wing machineguns are used mainly to fight enemy aircraft, although strafing runs against enemy infantry are not uncommon.

Primary Purpose: Anti-aircraft.

Secondary Purpose: Anti-personnel.

Mega-Damage: A burst is 10 rounds and does 1D6×10+10 M.D.; can only fire bursts.

Rate of Fire: Equal to the number of hand to hand attacks of the gunner.

Effective Range: 2000 feet (610 m)

Payload: 2000 rounds each.

6. Force Field: An energy field can be activated to protect the aerodyne. The force field "regenerates" damage at the rate of 8 M.D.C. per minute (4 melee rounds); if the field's M.D.C. is depleted, it shorts out and cannot be redeployed for two hours.

7. Sensors, etc.: The aircraft has all the same basic sensors, communications, and environmental features as most giant robots.

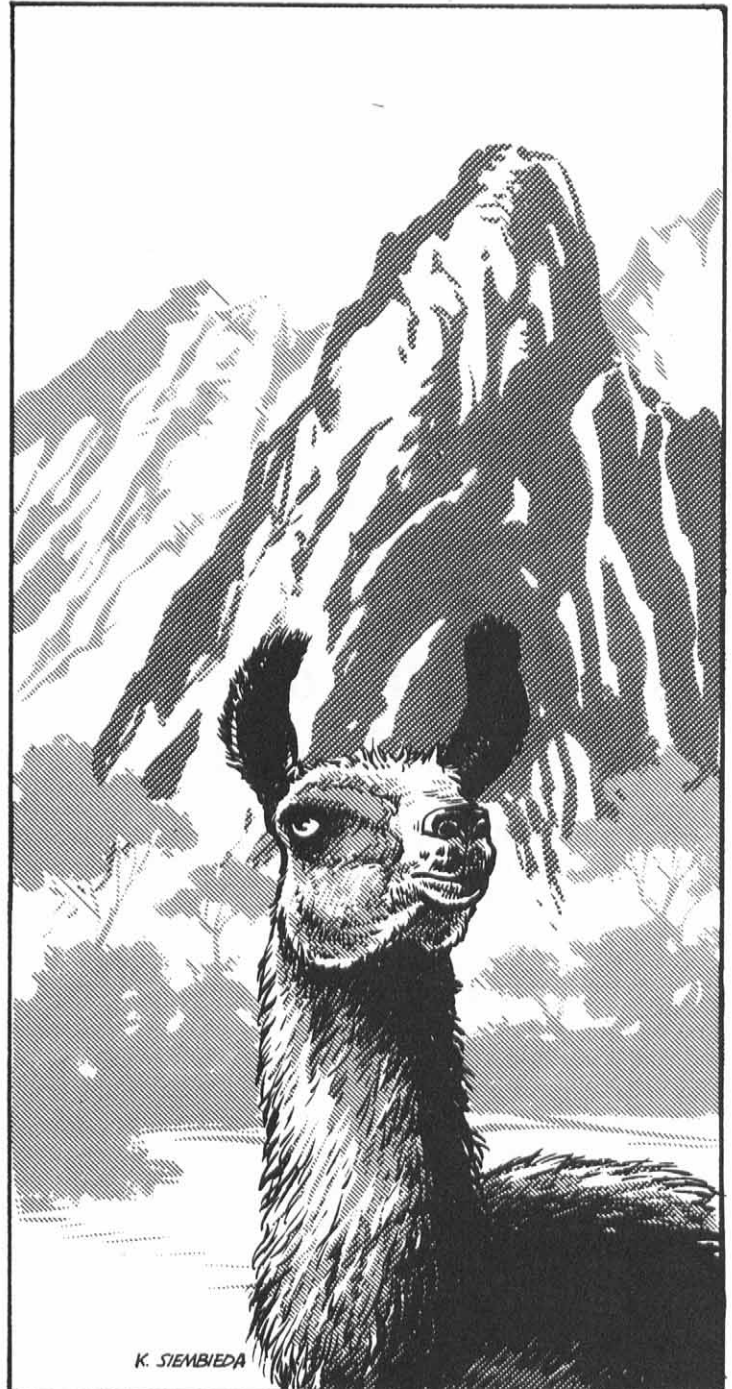

The Silver River Republics

“By reasons of geography, most of the Silver River Republics either hug the mountainous Andes chain, or concentrate in the rich plains — called *pampas* — where food and cattle can be raised to feed the growing human and transdimensional communities. Beyond these considerations, however, there is an amazing amount of variety between these republics (kingdoms, we would call them); each with a range in size, technological development, general policies of toleration, and forms of government. Besides the major four powers that jockey for dominance on the continent, dozens or perhaps hundreds of smaller settlements struggle to survive and show that their own brand of social engineering is superior to the rest.”

— From the *Cudbury Journals*

The Silver River Republics are not a single nation, or even a confederation of nations. Their only claim of unity is their collective name, a throwback to the ancient republic of Argentina, the “Silver Country.” Geography, wars, diplomatic intrigue and commerce link the nations together; beyond that, they have little in common. The SRRs range from human kingdoms not unlike the Coalition or the NGR, to enclaves of aliens, mutants and D-Bees.

The four major Silver River Republics are fully described below. They include two human nations, the *Republics of Cordoba* and *Santiago*, the mutant ruled *Achilles Republic*, and *New Babylon*, an enclave of humans and D-Bee colonists. About a dozen more kingdoms or independent republics are scattered between these nations, as well as some large groups and organizations whose influence extends across national borders; some of them are described in the Other Republics section.

The Republics of Cordoba & Santiago

These two “kingdoms” are the largest human-dominated nations in the Southern half of the continent. Cordoba is the largest human nation in South America and is only second to the Coalition States in the Americas. Like the CS, Cordoba is a human supremacist culture, rejecting all D-Bees (called *Dimensionales* in Spanish) and mutants as demonic interlopers who pose a threat to all. Santiago is more tolerant, but it is also predominantly human and has some degree of prejudice against nonhuman beings. Ironically, these very similar countries are on the brink of war with each other; Cordoba wants to unify the two human kingdoms, by force if necessary, and Santiago will fight to protect its independence. Only the potential threat of the Arkhons to the West and the mutants and D-Bees to the South has kept these two countries at peace, and even such threats may not suffice for long.

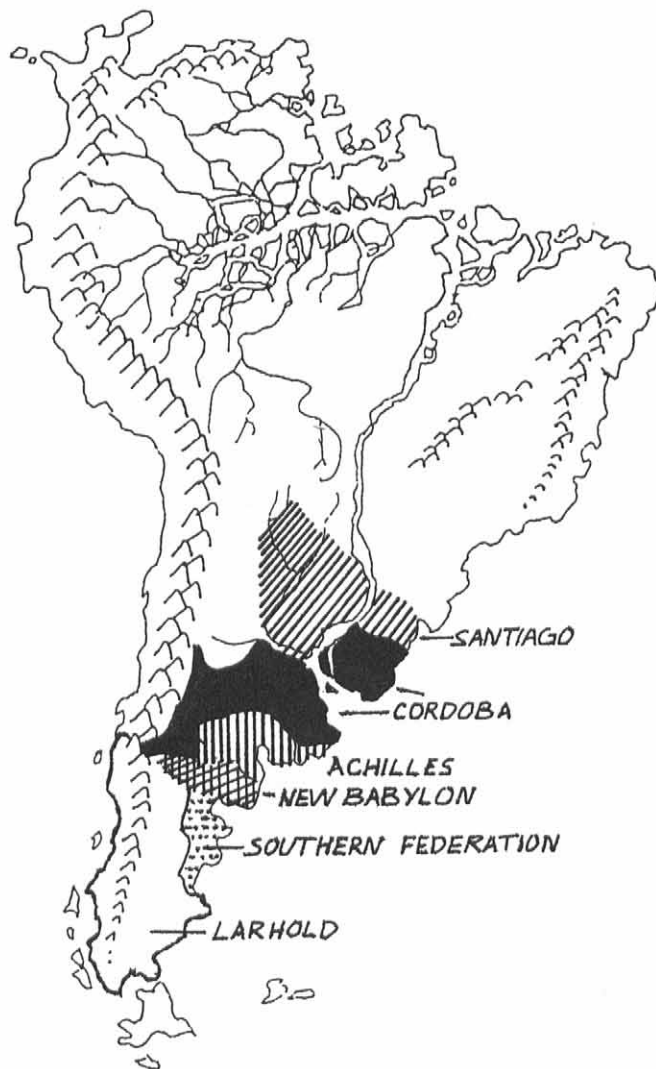

Republic of Cordoba

Population Breakdown: 5 million citizens (98% human). An additional million *other* people also live in the territory, of which about 40+% of these are D-Bees; non-humans are not allowed in most cities and towns. This doesn't include wandering tribes of *Larhold Barbarians* that constantly raid the people of the region and wander the plains. At any given time, there can be as many as 100,000 (2D6×10,000) of these barbarians, despite repeated efforts by the Cordoba government to expel or exterminate them.

The Cordoba Republic extends from the Andean mountain chain to the Atlantic Ocean. Several hundred miles of the Greater Amazon river runs through the territory and is used for transport and fishing. Its neighbors include Santiago to the north, the Arkhon Freehold to the west, and the Achilles Republic to the south. Most people live in the fertile plains, used for agriculture and cattle ranching. Military bases dot the landscape and

protect the frontier by watching over all major roads, natural passes, waterways, and large communities.

Cordoba is a major industrial center. Advanced weapons, including the dreaded Glitter Boys, are produced here. Cybernetics, M.O.M. conversion and the juicer treatment are all available. The overall technology is comparable to the Coalition States, although it lags behind Triax, Japan and Atlantis. Its strong technology and size makes this nation one of the most powerful in the area, enabling it to absorb or conquer many of its smaller neighbors. At this point, conflict is brewing between Cordoba and every nation around its borders. A state of war already exists to the south and west, and it is possible that Cordoba will start a war with the human republic, Santiago.

History

The city of Cordoba was one of the largest cities in South America, located in the heartland of Argentina, and was a vital industrial center. Although the Great Cataclysm devastated the original city, the survivors managed to rebuild the ruins and restore it to its former glory. The survivors were led by *Manuel Borges*, a wealthy cattle-rancher with a flair for leadership and who showed courage and charisma. Backed up by his tough *gauchos* (cowboys), Borges soon controlled a small army equipped with looted military equipment. The rancher was himself a former military officer, and his knowledge of tactics allowed him to defend his people from many supernatural threats. In less than a decade, a small town had been built near the shattered remnants of Cordoba. Borges kept the settlement alive through a mixture of genius and ruthlessness. When hordes of refugees threatened to overwhelm the township's supplies, Borges ordered them kept out at all costs, even if it meant firing on the desperate people. The town survived, and it slowly grew in size. When Borges died at the ripe age of 87, Cordoba had almost 10,000 people — a shadow of its former self, but still a large settlement by the standards of that time. He was succeeded by his son, Raul Borges, starting a bloodline that has persisted to the present day. The Borges family has had its share of tyrants, incompetents and cowards, but the nation it founded has managed to survive and prosper.

The current ruler of Cordoba is *Manuel Borges III*, who seems to have inherited his ancestors' qualities of toughness and ruthlessness. Manuel is 39 years old, a former army colonel, and a veteran in dozens of border wars and skirmishes. He is a competent soldier whose exploits have made him very popular. Borges wants to unify all humans in the region under his rule, and is prepared to go to war to do so. This naked ambition may spell doom for all human settlements, since alien threats like the Arkhons and the Larhold Barbarians may take advantage of a war situation.

Government and Society

Although formally called a republic, Cordoba is a kingdom in all but name. The Borges family has kept a firm grip over the government for three centuries. As the wealthiest and most famous clan, the Borges are still seen as the saviors of the nation and the only leaders worthy of the title. Occasionally, a weak or inept Borges has risen to the presidency, but other family members have stepped in and either deposed him or ruled as the "power behind the throne."

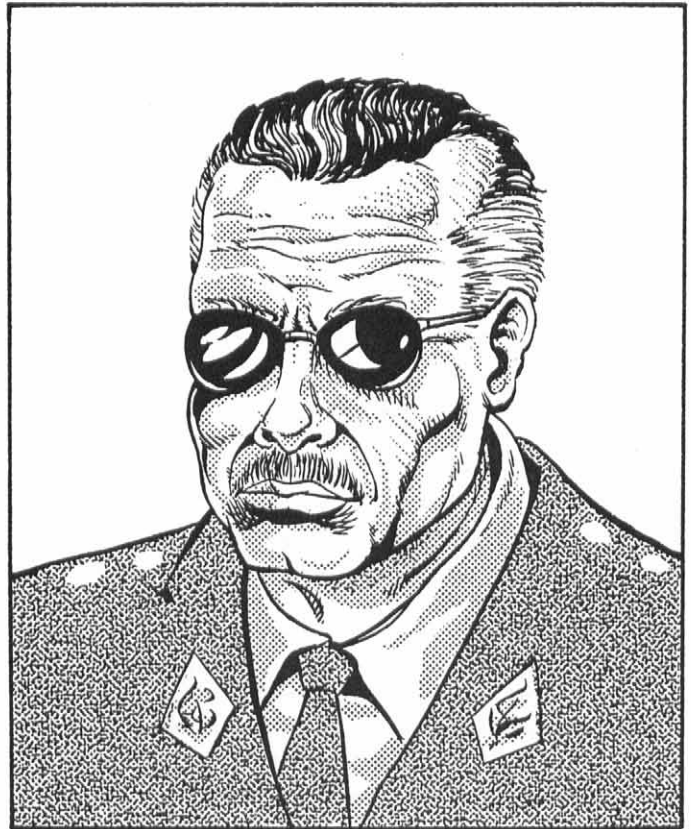

K. SIEMBIEDA '95

The Borges line is handed down through the male side of the family. Borges women who marry "lose" the Borges name, as do their progeny. So far, there have been enough male heirs to guarantee an unbroken family line. Typically, the ruling Borges writes a will naming his successor at the time of his death or retirement. This name is kept secret until such time, to make sure the would-be president doesn't get too ambitious and decides to help the current president on his way.

The ruler has the title of "President for Life" and has control over the armed forces, the police (considered a part of the army), and the government. He personally appoints a number of Ministers who assist him in running things. These ministers cover such areas as the Treasury (which includes taxation, minting coinage, etc.), Defense (the second in command over the army), and Health, among others. Typically, there are 4-12 ministers serving under one president. Ministers are usually chosen from other prominent families, or from people the president can trust. An unspoken agreement exists preventing any member of the Borges family to assume the position of Minister. Typically, the other Borges can be found as deputy ministers, assistants and in other secondary positions where they get to learn how to run the country. Such an arrangement also provides them with the opportunity to spy on the ministers to make sure they are doing their job properly.

There is no congress or similar parliamentary body in Cordoba. The wealthiest and most prominent families, which are involved in cattle and farming interests, trading, industry, etc., usually have access to the president and can exert *some* informal influence on him, but other than that, the president has final say on everything. This has created a lot of resentment among some of the most powerful families, whose only way to power is to have one of their daughters marry into the Borges family and hope the children from those unions will one day become power-

ful. Plots to undermine or even overthrow the Borges family have been around for generations, but so far, haven't been successful.

The society of Cordoba changes a lot between the hustle of the big cities to the more relaxed and quiet life of the country communities. The farmers, cattle ranchers and wilderness scouts lead simple, if not always peaceful lives. Large landowners use tenant farmers (who work a lot of land and pay for it with a portion of their crops) and hired hands to tend to the large herds of cattle that feed the cities. The *Gauchos* (cowboys) who handle the cattle and call the vast plains their home, are fairly independent, rowdy, and tough. They have to be, to face the many dangers that lurk throughout the countryside: monster and D-Bee raiders, the Larhold Barbarians, demons, Rifts and other dimensional disasters, not to mention the more prosaic cattle thieves, stampedes, poisonous snakes, and similar dangers.

Although there is a lot of intolerance in the region toward non-humans, small D-Bee communities that show themselves to be peaceful and keep to themselves are often allowed to exist unmolested. Sometimes, however, army units will expel or attack those communities at the whim of the commander. The soldiers, together with the large landowners, are the law of the land. Sometimes the two forces clash with each other, especially when a local "noble" decides to defy the orders of the central government and the army is sent to teach him a lesson.

In the cities one finds the typical class divisions between the wealthy, middle class and the poor. Most city residents work in the factories that are the lifeline of the large towns. Machinery, tools and weapons are manufactured in the cities. In terms of technology, most of these factories are equivalent to those found in the Coalition States, and their products approach pre-Rifts quality. One of the best known factories produces Glitter Boys; repairs for this and other suits of power armor or robot vehicles are available in the cities. The workers at these factories live in small apartments and make up the bulk of the population. They enjoy steady, if not very high, salaries which allows them to acquire a number of luxuries, including computers, televisions and CD players. About 80% of the cities' population is literate and skilled with computers and technology, but in the countryside, the literacy rate is less than 30%!

About 20% of the city population are not as fortunate. These are vagabonds and desperate people out of work (victims of layoffs, factory shut-downs and other mishaps) or employed at low paying seasonal jobs. A lot of impoverished families live in miserable slums around the city proper. Literacy is less than 10% and many are peasant emigrants or the children and grandchildren of slum dwellers. Makeshift houses of brick and sheet metal fill the slums, and are often knocked apart by flash floods and storms. The slum dwellers are also ravaged by crime, and have a higher concentration of D-Bees than anywhere else. Often, human slum-dwellers will take out their frustrations on the D-Bees, especially since the authorities rarely investigate or prosecute the beating, robbery and even murder of a non-human. These slums are also the place to go to acquire all kinds of black market products, from illegal weapons and cybernetic implants to dangerous drugs.

The rich include factory owners, merchants, and cattle ranchers. The latter live well away from the cities and rule their land almost like medieval lords (see **the Caudillos**, below). This "no-

bility" only leave their ranches to get together with other members of their class, or to serve in the government or army. Prominent merchants and factory owners live in city manors, far away from the slums, and protected by armed guards. Government officials, many of whom are relatives or proteges of the Borges, enjoy many privileges and in many ways, are above the law.

Armed Forces

Located near but apart from most communities are military posts. Some are as small as watchtowers with less than a dozen soldiers or as big as military fortresses with over a thousand troops, aircraft, power armor and robots.

Cordoba has two military forces, the Republican Army and the National Guard. **The Republican Army** is a large, strong force, with an integral Air Force and Navy. Its duties are to defend the nation, and it answers only to the Borges Government. With this powerful national army, the Borges can keep the local landowners in line, as well as launch wars of conquest against other nations. Republican Army men (no women are allowed to join) are volunteers, well paid and equipped; they have the most powerful robots, tanks and power armor. The typical Republican soldier is the equivalent of the Coalition Grunt O.C.C., with the additional skills of literacy (Spanish; +25%) and computer operation (+15%). Equivalents to the CS Elite RPA, CS Military Specialist and CS Technical Specialists also exist within the Army. The Army also uses specialty soldiers, including 'borgs (see the *Plains 'Borg O.C.C.*), juicers and crazies.

The National Guard is charged with assisting the Army in defending the state. It also doubles as a police force in cities and towns. The guard is made up of conscripts; every citizen of Cordoba (male and female) must serve for two years in the National Guard. This mandatory requirement must be fulfilled between the ages of 17 and 20. Citizens who by their 21st birthdays have not served are subject to arrest and prison terms, unless they are exempt for reasons of physical disability, children (mothers and married couples can claim an exemption), or having an important or valuable skill, craft or job. About 5% of these recruits decide to stay in the Guard and form the core of the service, many of them becoming officers and non-coms. Besides a few helicopters and patrol boats, the National Guard is mainly an infantry force, with few tanks, robots or heavy vehicles.

The typical recruit is first or second level, and gains the following skills from Basic Training: basic radio (+10%), W.P. energy rifle, and hand to hand: basic. They typically have 4-8 non-military/combat skills at +5% to +15%. Trained full-time soldiers are equivalent to the modified O.C.C.s described above.

In addition to the two branches of the military, there is the **Internal Security Agency**, or ISA. This is a secret police agency controlled by the Borges, and used to ferret out and eliminate any opposition to the government. Common targets of the ISA include plotting magnates and rival families, terrorists and guerrillas like the Shining Path movement, criminal organizations and the black market, labor leaders and union organizers, rebellious university students, and anybody who dares defy the government. Although most ISA agents are plainclothes detectives, the agency has access to advanced weapons, and can field two armored divisions (typically divided up into smaller units and used in limited operations). The ISA also has a Special Branch

used against enemy nations. The Special Branch includes a number of psychics, mages, and beings with unusual powers, including a few D-Bees, the only non-humans allowed to serve in the Cordoban military.

Foreign Relations

Santiago: The second largest human nation in the SRR, Santiago has had a cordial relationship with Cordoba for over a century. All this has changed since Manuel Borges rose to power. To Borges, Santiago is too valuable to be left alone; he wants to absorb that human nation and use its resources in a war of genocide against all non-human kingdoms in the area.

The Achilles Republic: The mutant homeland of South America is a mortal enemy of Cordoba. The refusal to accept mutants as anything other than slaves or monsters to be destroyed makes it impossible to have normal relations between the two countries. Past rulers of Cordoba have not even consented to admitting ambassadors from Achilles into the territory; they consider it beneath their contempt to deal with "talking animals!"

New Babylon: Cordoba hates New Babylon, despite the fact that trade with that human-alien nation is very profitable for both sides. Past humiliations, inflicted at the hands of the Babylonians, have earned New Babylon the Cordobans' lasting enmity, ranking just below the Achilles Republic (see above) on Borges' "enemies list." Still, at least for the moment, they hide their feelings and grudgingly trade with them.

The Empire of the Sun: Although the Inca Empire favors humans over other species; the living "gods" who are said to rule that mysterious land are a source of concern for Borges and his cronies. Occasionally, Cordoba soldiers make probing raids into Inca territory, but little is known about the Empire, other than its soldiers have a lot of magical assistance and that god-like beings (non-humans) walk among them.

The Arkhon Freehold: The alien invaders control areas that touch on Cordoba's borders. Since both nations have more important enemies to deal with, contact is limited to occasional skirmishes and, once or twice a year, a small battle along the border. At some point, however, Borges wants to claim all the land to the foot of the Andes, and exterminate the aliens.

The Republic of Colombia, Maga Island and the Kingdom of Bahia: These three nations do a great deal of trading with Cordoba, Santiago and other republics. Beyond the trading, however, no other contact has been made. Borges knows that a number of human kingdoms lie to the North, and he hopes one day to bring them under his rule. First, of course, all the non-humans between them must be eliminated.

The Kingdom of Lagarto: No formal relations have been established. The authorities of Cordoba know of this lizard man kingdom, and believe it is to blame for the attacks on shipping going up the Greater Amazon river. The Cordoba Navy sent a flotilla of two light cruisers and three frigates up the river, but constant attacks by lizard men and their dragon overlords sank all but two. At this point, all shipping North is made through the Atlantic Ocean. Borges and his minions have sworn revenge and lizard men (most of them completely innocent of any crime) are arrested or executed on sight.

The Coalition States: The same embassy that recently visited Colombia (see *South America Book: One*) has made contact

with the human kingdoms further south. The Death's Head Transport returned to Chi-Town bearing ambassadors from Cordoba, and Prosek and Borges have started to write each other; they see each other as a fellow conqueror, a relationship somewhat similar to that between Hitler and Mussolini during World War II. Beyond these diplomatic exchanges and the use of each side's victories for propaganda purposes, there is little contact. Travel between the two distant nations, even using nuclear-powered aircraft, is too risky to become commonplace. A formal alliance between the two nations is in the works, although it will have little if any military value. On the other hand, known enemies of the Coalition seeking refuge in this far-off land will find themselves persecuted by the authorities.

The Coalition has a standing feud with one of Cordoba's neighbors, the Achilles Republic. CS agents have started to travel through Cordoba to spy on and sabotage that mutant-controlled nation. The Cordoba government condones and often aids the CS in these endeavors, providing the agents with guides, supplies and additional troops. These activities may eventually lead to war with the Achilles Republic.

Atlantis: Other than the occasional raid, there is no contact between Atlantis and Cordoba. The Cordobans know that some alien force is operating off the north coast of the continent, but knows very little beyond this.

Other Nations in North America and Europe: There is very little contact with the rest of the world. Cordoba knows only the barest details of such nations as the Vampire Kingdoms, Iron Heart, Free Quebec, NGR, the Phoenix Empire, and others.

Seafaring Nations: There is some trade between Cordoba and Tritonia, the drifting colony. This trade is conducted by individual merchant ships, however, and there is no formal contact between the governments. The mythical **New Navy** occasionally patrols the waters of the Atlantic, rescuing ships in danger. Also, pirates and alien beings like the Horune and the Naut'Yll often attack local shipping and make occasional inland raids. Refer to *Rifts Underseas* for more information about all these organizations, nations and monsters.

Cordoba City

Population: 120,000 (90% human, and 10% assorted D-Bees, mostly living in the slums).

The capital of Cordoba is located near the ruins of the old city of the same name. The location is ideal for a settlement, being on the river banks of a tributary of the Greater Amazon. The river is wide enough to allow oceangoing vessels to travel through it, and the city is a major trade center, with vessels bound for many places in South America (and lately, a few intrepid merchants venturing North into Europe and Africa or the floating city of Tritonia) stopping here to sell or load cargo. The Palace of Government, where the Borges Family rules and lives, is on top of a hill overlooking the entire city. The palace also doubles as a fortress, and it has the best weapons and defenses Cordoban technology can produce. The city markets do a brisk business in everything from cosmetics to weapons. Travelers into the city are not allowed to carry anything heavier than a light energy pistol and light body armor; weapons and robots purchased in Cordoba are not given to the travelers until they have been escorted outside city limits. Any disturbance and violence is dealt with quickly and without mercy by the **National Guard** or the **Republican Army**.

Republic of Santiago

Population Breakdown: 3.5 million citizens (85% human, 5% lizard men, 10% various nonhuman races, including jungle elves, goblins, and mutant animals) plus an additional 1.3 million D-Bees, refugees and indian tribes live in the region, away from the cities and settled areas. As in Cordoba, wandering bands of Larhold Barbarians typically add an additional 2D6×10,000 to the population.

Santiago is the second largest human kingdom in the area. Its territory ranges from the Amazonian jungle to the north, to the plains in the south, and controls both shores of the Greater Amazon for a good stretch of the river. To the west lies the Empire of the Sun and some outposts of the Arkhon Freehold. In the south is one-time ally, Cordoba, but now a growing threat to their freedom.

A wealthy industrial nation, Santiago is far more tolerant of D-Bees than Cordoba and most of the other kingdoms. Although humans are by far, the largest group in the nation, beings of dozens of other species can hold jobs, join the military, and even become government officials. This attitude has earned Santiago the enmity of many human kingdoms, particularly the Republic of Cordoba.

History

The region of Santiago is located in Argentina and was one of the first nations to rise out of the ashes of the Great Cataclysm. During the years of chaos, random Rifts deposited several thousand humanoids from other dimensions in the region. Some of these humanoids had magical or technological knowledge that would prove to be very useful in surviving the dangers that beset the planet. Fortunately for the human refugees who encountered these D-Bees, the newcomers were friendly and compassionate. Humans and D-Bees struggled, lived and survived side by side. As the small community grew in size, more and more human and inhuman refugees flocked to the area. Unlike the cold-blooded rulers of Cordoba, the first settlers of Santiago did not have the heart to turn away any of these unfortunates, and in some cases, this hurt the colony, bringing about times of famine and scarcity that sometimes killed as many as half the entire population! Other disasters, including ley line storms, monster activity and warfare with other fledgling settlements, cost more lives.

Through luck, hard work and the use of both magic and technology, however, Santiago survived. By the early years Post Apocalypse (P.A.), several fortified towns and a true city had risen from the ashes. A central government elected by the votes of the most prominent property holders was founded to oversee the nation. The towns and cities grew rapidly, and by 50 P.A., a strong nation with a population of over two million people now existed.

At first, relations with the other human nations were strained but peaceful. Santiago had developed enough technology and weapons to protect itself from raiders and bandits. Cordoba, the other leading human nation, became, at first, a tentative ally in

the battles against the Larhold and other threats. Eventually, however, Santiago's tolerance towards D-Bees and the ambition of Cordoba's ruler led to today's enmity.

Government and Society

Santiago's government has two branches, partially inspired by the democratic governments of pre-Rifts Earth. The executive branch is in the hands of the president, elected by the direct votes of all eligible citizens. Also elected through voting, the Senate passes laws and forms the legislative branch. Both the Senators and the President serve six year terms, and can stand for re-election indefinitely. The balance of power between the two branches changes back and forth from election to election.

Although voting plays a major part in the shaping of the government, Santiago is not, strictly speaking, a true democracy. Only eligible citizens can vote in the elections. Eligibility is directly tied to wealth; the people with an income of 40,000 credits a year, born in the Santiago territory, and not currently serving in the army can vote. Since the average yearly wage in the nation is about 10,000 credits a year, only a small fraction (roughly 20% of the population) has the right to vote! Wealth is the source of power in this republic.

Despite this inequality, the government does try to work for the benefit of all the people. Although most cannot vote, they can channel their discontent in many other ways, from demonstrations to outright revolt, and the ruling class does not wish to see that happen. Instead, the government tries to balance the desires of the wealthy constituents with the needs of the rest of the people. While this balance is not perfect, it has kept Santiago functioning for decades.

The current government is led by *Yolanda Morales*, the first female president in the country. A tough but attractive woman in her early forties, Yolanda served in the military for several years, and then in the civil government in a number of positions. Morales and her administration wishes to promote tolerance and friendship between humans and other races. She keeps telling people, "The danger of the Arkhon aliens is too immediate to waste time bickering about the shape of one's neighbor." These beliefs have not endeared her to either Cordoba or the most extremist factions in Santiago. However, the majority of the people agree and support her.

Santiago's population is nowhere near as intolerant of non-humans as Cordobans. Many D-Bees, mutants and other beings are allowed to live and work in the cities of Santiago. D-Bees with enough money are allowed to vote, just like everyone else. Things are not perfect. D-Bees are often discouraged from going to certain exclusive establishments, mixed marriages are considered to be scandalous, and many stereotypes about D-Bees ("Yeah, all *Dimensionales* are greedy thieves; don't leave them alone with the good silver!") are believed to be true by a larger percentage of the population. Bands of young racist punks occasionally attack D-Bee neighborhoods, assaulting and sometimes killing innocent people. The police and military do their best to crack down on these outbreaks, but they still occur with alarming regularity. Thankfully, damage and injuries are seldom too serious and the majority of humans and D-Bees live and work in friendship and harmony. Attacking or persecuting D-Bees is considered a crime and the perpetrators are punished. Except for the most ignorant and criminal-minded dregs of society, the citizens of Santiago believe in "live and let live."

Life in the cities and the country is very similar to conditions in **Cordoba**. The population in Santiago has a higher level of literacy (70% versus 60% in Cordoba) but for the most part, the people in the two nations are extremely similar. It is best not to comment on those similarities, however; the citizens of both nations are fiercely nationalistic and they consider themselves to be completely different (and, of course, superior) to the other. This attitude is one of the major obstacles between a unification between Cordoba and Santiago — and it will most likely lead to a war.

Armed Forces

Santiago has a small standing army, the **Santiago Defense Force**. Additionally, it can field a Citizen's Militia. The Defense Force is a highly-trained and well-equipped force, designed to counterattack in case of invasions and raids. It relies on power armor, robots and Glitter Boys, and has a special forces group made up exclusively of humanoids and D-Bees with strange powers (see the Special Phalanx).

The Citizen's Militia is made up of part-time volunteers who undergo a training period and then must serve one week every other month and stay in reserve the rest of the time. Most militia members are business professionals, shopkeepers, craftsmen and laborers who see it as their duty to be ready to defend their country. In theory, the entire militia is activated only in cases of emergency. Regrettably, such emergencies occur almost on a monthly base, so the militia is almost always on alert.

The Special Phalanx

La Falange de los Especiales (or simply "*Los Especiales*," the "special people") is an army Corps (4 divisions, about 40,000 troops total) comprised of unusual creatures, humans with special powers (including Juicers, Crazies, Anti-Monsters from Colombia and TW Crazies), mages and shamans, D-Bees and similar "gifted" soldiers. The Phalanx is an all-volunteer army that relies on the extraordinary abilities of its members rather than on heavy weapons and equipment. Each division only has one attached armored company (12 tanks and 12 robots total per division), and only transport vehicles. The Phalanx' Table of Organization and Equipment (TOE) lists all troops as "light or medium infantry." This refers to their equipment; typically only small arms and rifles, with very few heavy weapons and power armor. This is because many of the soldiers provide their own "heavy artillery" in the form of magic spells, super-powers, psionics, and other abilities.

Foreign Relations

Cordoba: The two nations have been loosely allied for many years, but are now on the brink of war. A year ago, the Borges government started pressuring Santiago to sign a treaty of military cooperation. One of the treaty's clauses required Santiago to send half of its troops south, to join a campaign against the Achilles Republic. Santiago has no quarrel with that mutant kingdom; besides, the Santiago government fears this is a ploy to divide and weaken the country's armed forces, making a take-over easier. The Morales government politely refused to sign the treaty and offered a different one, a non-aggression pact where both nations would agree not to attack one another under any circumstances. Borges refused to accept the counter-offer. Instead, he has made a number of requests for a binding alliance

leading to a formal union of the two countries. At the same time, the Cordoban Army has started massing in the north, near Santiago's border. President Morales has ordered the Santiago military to raise its level of readiness and fears that war will erupt any day. Any incident could trigger a conflict.

Other Silver Republics: Santiago has little direct contact with Achilles or New Babylon except through limited trade. As the danger from Cordoba increases, however, Santiago's government is considering making an alliance with those two nations. Together, Santiago, New Babylon and Achilles outnumber Cordoba, but pro-human factions are suspicious of the other two non-human dominated nations.

The Arkhons: The aliens sometimes raid Santiago, and the government fears (rightly) that the Arkhons plan to take over the entire continent.

CS and Others: Santiago has had little contact (and has little knowledge) about nations beyond the South American continent. All they know of the Coalition States is that it is the power in North America and has recently made some loose ties to Cordoba (good reason to regard the CS with suspicion and concern).

Common O.C.C.s in Santiago and Cordoba

In addition to the new O.C.C.s listed in this section, the following O.C.C.s and R.C.C.s are common in these two nations, and in many of the smaller Silver River Republics as well:

Headhunters and Wilderness Scouts: Remain unchanged. They typically serve as mercenaries, army specialists, scouts, and similar assignments, as well as adventurers.

Glitter Boys: Both Santiago and Cordoba, especially the latter, have large contingents of both standard (GB-10) and modified Glitter Boys (including GB-7s). These elite pilots are highly valued by both sides.

Ley Line Walkers, Mystics and Shifters: Magicians are persecuted in Cordoba. In Santiago, magic is tolerated as long as it is not used to commit crimes, and *is* used to benefit the country. Line magic is not known to this nation.

Techno-Wizards: In Santiago, techno-wizardry is beginning to be adopted as a regular "science." The success of such projects as the Techno-Wizard M.O.M. enhancements (see the **TW Crazy O.C.C.**, below) has given a lot of popularity to this peculiar art.

Cyber-Knights: Only a relative handful of these champions have reached South America.

City Rats, Operators, Cyber-Docs and Rogue Scholars: All these O.C.C.s are common in cities, especially in the slums and unsavory areas.

Other O.C.C.s: Anti-monsters, sailors, pirates, tribal shamans, totem warriors, biomancers (from *South America Book: One*), bounty hunters, special forces soldiers, thieves, smugglers, spies, (from *Rifts Mercenaries*), and temporal wizards and warriors (*Rifts World Book Three: England*) all exist in this part of the world.

Other R.C.C.s: Lizard men and jungle elves (see *Rifts South America: One* and *Rifts Conversion Book One*) are very common, especially the jungles to the north. Goblins (see the *Conversion Book One*) are somewhat common in Santiago. Any other race from **Rifts®** sourcebooks and world books could also exist but in tiny numbers or as part of an adventurer's group.



K. SIEMBIEDA '95

Gaicho O.C.C.

Much like cowboys in the American West, gauchos are figures of myth and legend in the plains of South America. Tough horsemen who worked on cattle ranches, gauchos were romantic heroes and rogues. They were well known for their skills in knife-fighting, the bola and horsemanship. As technology made the need for horsemen disappear, the gauchos dwindled in numbers, becoming tourist attractions and old men reminiscing about lost times. The Coming of the Rifts and the wild, lawless chaos that followed have resurrected this ancient brand of adventurers. The cattle ranchers of the second century P.A. have to contend with transdimensional monsters, bandits, cattle rustlers, alien raiders, predators, and each other. The traditional knives and bo-

las have been replaced by technological equivalents; vibroblades and energy or exploding snares. Horses are often replaced with motorcycles or off-road vehicles and many Gauchos now ride on *cyber-horses*, partial conversion mounts with heavy armor, able to run as fast as a car and capable of surviving attacks that would kill any normal horse. Others favor *robot horses*. Given the dangers the gauchos face, the wealthy landowners who hire them are happy to provide them with all kinds of high-tech goodies, from energy weapons and cybernetic or bionic implants to robot horses.

The typical gaucho works for a cattle ranch, helping watch over the vast herds that feed the Silver River Republics. Some of them often leave the ranch life for more adventuresome occupations, and act as bodyguards, bounty hunters, scouts and merce-

naries. Some even become heroes. Their skills as trackers, riders and fighters allow them to gain easy employment in the armed forces, outlaw gangs, adventurer groups, and other dangerous occupations.

O.C.C. Abilities and Bonuses:

1. Physical Bonuses: The harsh lives of the *pampas* (plains) harden these adventurers. Add 4D6 to S.D.C. +2 to P.S., and +1 to P.E.

2. Combat Bonuses: +2 on initiative, +1 to strike and parry from horseback (applies to hand to combat only), +2 to roll with impact or fall, +2 to pull punch, and +3 to save vs horror factor. As knife specialists, they are at +1 to strike and parry with knives, +2 to strike when thrown, and can use them as paired weapons (usually vibro-knives). All bonuses are in addition to attribute and skill/W.P. bonuses.

Alignments: Any, but many seem to lean toward good.

Attribute Requirements: P.P. and P.E. 12 or higher.

O.C.C. Skills:

Language: Spanish (98%)

Literacy: Spanish (+15%)

Basic Math (+10%)

Horsemanship (+25%)

One piloting of choice (+10%)

Tracking (+15%)

Detect Ambush (+10%)

Wilderness Survival (+15%)

W.P. Knife

W.P. Bola (treat as Archery & Targeting)

W.P.: two of choice

Hand to Hand: Expert

Hand to Hand: Expert can be converted to hand to hand: martial arts (or assassin if evil) at the cost of one "other" skill.

O.C.C. Related Skills: Select seven other skills. Plus select one W.P. and one skill at level three, two skills at level six, and one skill at levels nine and twelve. All new skills start at level one proficiency.

Communications: Any (+10%)

Domestic: Any (+10%)

Electrical: Basic Electronics only

Espionage: Detect Concealment and Sniper only.

Mechanical: Automotive only.

Medical: First aid and paramedic only.

Military: None.

Physical: Any except acrobatics.

Pilot: Any (+10%)

Pilot Related: Any (+10%)

Rogue: Any

Science: Any

Technical: Any (+5%)

W.P.: Any

Wilderness: Any (+10%)

Secondary Skills: The character also gets to select two secondary skills at levels one, three, six and ten. These are additional areas of knowledge that do not get the benefit of the bonus listed in parentheses. All secondary skills start at the base skill level. Also, secondary skills are limited (any, only, none) as previously indicated in the list.

Standard Equipment: Suit of medium body armor, two vibro-knives, two energy bolas, two regular knives, an energy

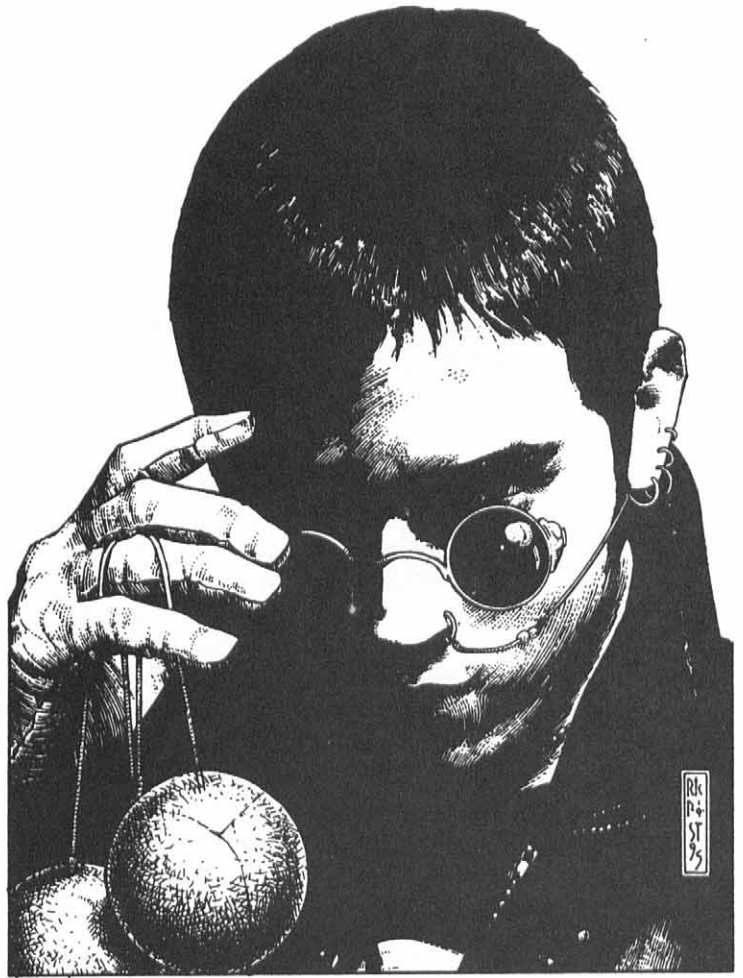

weapon of choice and four spare E-clips, one non-energy weapon of choice and either a real horse, cyber-horse, robot horse, or a motorcycle, hover cycle or small one-man vehicle of choice. Plus camp kit (small shovel, wood axe, lighter and matches, flashlight, sleeping bag/bedroll, survival knife, dry rations for 2D6 days, canteen), two sets of work/travel clothes, and one set of good clothes for fairs, festivals and public occasions.

Money: 2D4x1000 credits.

Cybernetics: Starts with 1D4 cybernetic implants and two bionic implants, limbs or weapons (short of partial or full bionic reconstruction).

Plains 'Borg O.C.C.

Given the technology levels of such republics as Cordoba and Santiago, full bionic conversion is commonplace. A few *gauchos* have given up their humanity either to become feared warriors (*machismo* is alive and well in the SRR), or to better defend their people from supernatural threats. These cyborg champions are designed to ride on the range on robot horses or aboard hover cycles or motorcycles. Although lightly armored by Coalition standards, these cyborgs have superior reflexes and coordination, and a lot of hidden weapon systems. Typically, the "cyber-gauchos," as they are called, hide their metallic forms with capes, ponchos and hats, sometimes fooling the unwary until they are within arm's length.

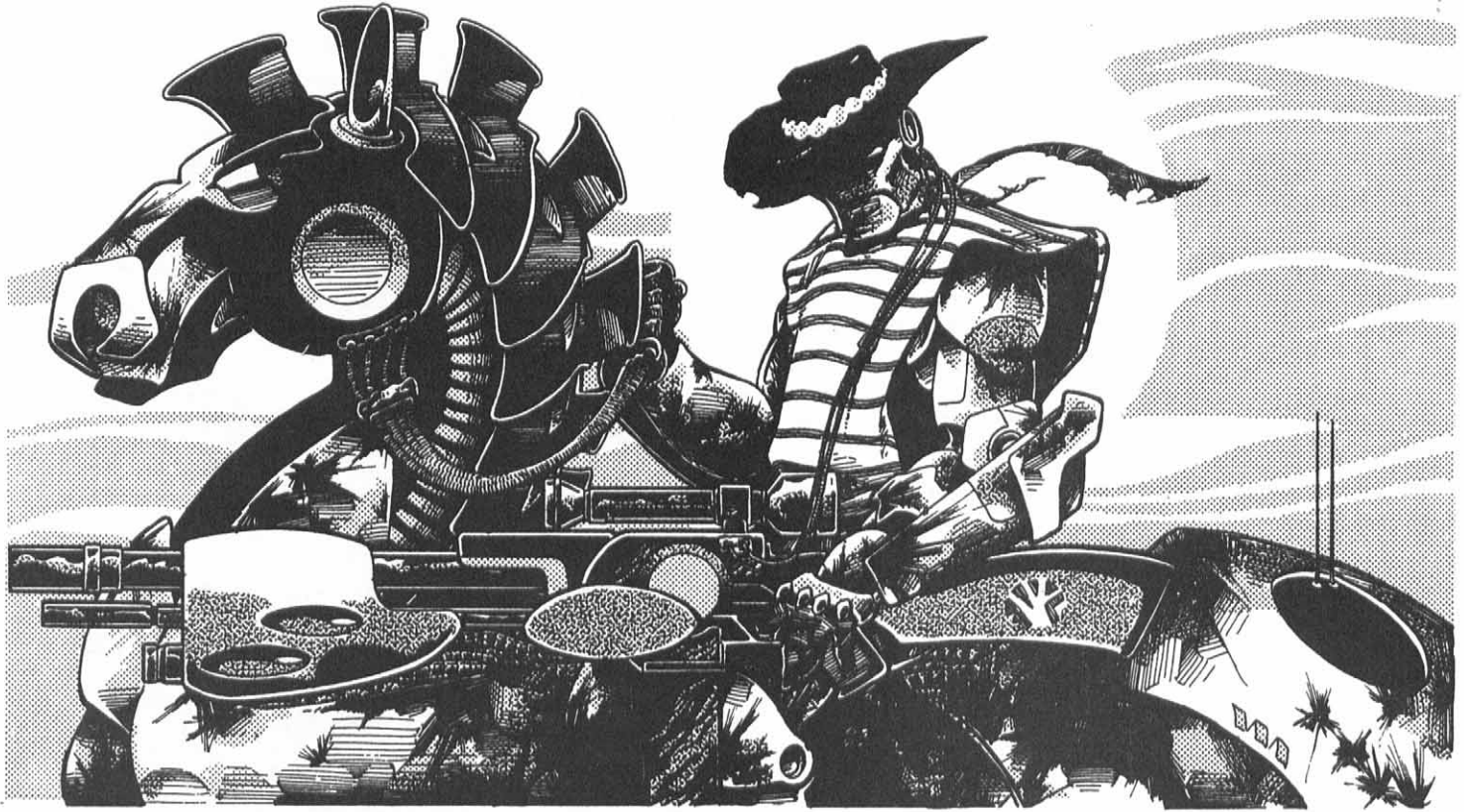

These former gauchos are given their bionic enhancements for a number of reasons. Sometimes they are the survivors of a savage battle or a terrible accident, and would be crippled for life if they weren't "rebuilt" through bionics. Some teams of gauchos often put aside large sums of money to be used in such an eventuality. Others are volunteers who are given their new bodies to better serve as warriors and defenders of the land. A few are survivors of Larhold raids (see the *Larhold Barbarians* section) who have suffered such tortures that they are willing to sacrifice their humanity to pay them back.

These cyborgs are respected and feared by all and the scourge of the Larhold Barbarians, mercilessly tracking those D-Bee raiders and killing them, sparing none! In return, captured 'borgs are killed horribly by the Larhold; the most common (and least imaginative) method of torture consists of slowly ripping out all bionic components until only the flesh and organs of the 'borg remain. Most plains 'borgs will never let themselves be captured by the Larhold, fighting to the death rather than face the barbarians' "mercy."

Most of these cybernetic warriors ride on robot horses or cyber-horses ('borg animals), altered to match their riders. A handful ride the same dinosaur-like mounts of the Blood Riders or other monstrous riding animal. They favor long, heavy energy weapons that enable them to take down targets at great distances. A favorite tactic against Larhold barbarians is to trick the raiders into pursuing a smaller band of 'borgs. While letting their cybernetic horses carry them off, the 'borgs twist and shoot at their pursuers from ranges further than the Larhold bowmen can shoot. Sometimes, a 'borg will shoot down five or six Larhold before the barbarians realize they'll never catch their quarry and give up. However, the wily D-Bees often lure the running 'borgs into an ambush by placing riders ahead of them

and surrounding them. Life in the plains is a series of such stratagems and dirty tricks.

O.C.C. Abilities and Bonuses:

1. Bionic reconstruction: Plains 'Borgs undergo full bionic conversion. As a result, they gain 280 M.D.C., P.S. 26 and P.P. 22., Spd. 176 (120 mph/190 kmph). They also have the following bionic and cybernetic systems: bionic lung, built-in radio receiver, sensor hand, and multi-optic eyes.

2. Bionic bonuses: +1 to strike with a long-range weapon, +2 to parry, dodge or roll with punch/impact, +1 to pull punch and +4 to save vs horror factor.

3. Other Bionic and Cybernetic Implants: The character can choose up to three bionic limb modifications, weapons or enhancements and three cybernetic implants of choice, in addition to the ones listed above. Further modifications must be purchased, or gained as rewards during the course of play. See the *Rifts® RPG*, *Triax™*, and *Rifts Japan* for a wide variety of bionic systems.

Alignment: Any, but tend to be good or selfish.

Attribute Requirements: M.E. 12 or higher.

O.C.C. Skills:

Language: Spanish (98%)

Literacy: Spanish (+15%)

Basic Math (+10%)

Horsemanship (+15%)

One piloting of choice (+10%)

Tracking (+10%)

Detect Ambush (+10%)

Wilderness Survival (+10%)

W.P. Knife

W.P. Bola (treat as Archery & Targeting)

W.P.: two of choice

Hand to Hand: Expert

Hand to Hand: Expert can be converted to Hand to Hand: Martial Arts (or assassin if evil) at the cost of one "other" skill.

O.C.C. Related Skills: Select six other skills. Plus select one W.P. and one skill at level three, two skills at level six, and one skill at levels nine and twelve. All new skills start at level one proficiency.

Communications: Any (+10%)

Domestic: Any (+10%)

Electrical: Basic Electronics only

Espionage: Detect Concealment and Sniper only.

Mechanical: Automotive only.

Medical: First aid and paramedic only.

Military: None.

Physical: Any except acrobatics.

Pilot: Any (+10%)

Pilot Related: Any (+10%)

Rogue: Any (+2%)

Science: Any

Technical: Any (+5%)

W.P.: Any

Wilderness: Any (+10%)

Secondary Skills: The character also gets to select five secondary skills. These are additional areas of knowledge that do not get the benefit of the bonus listed in parentheses. All secondary skills start at the base skill level. Also, secondary skills are limited (any, only, none) as previously indicated in the list.

Standard Equipment: Suit of light cyborg infantry armor (270 M.D.C.), an energy rifle of choice, one additional energy weapon of choice, four E-clips for each weapon, a vibro-knife, two energy bolas, one non-energy weapon of choice, a survival knife, camp equipment, a poncho or cloak and a wide-brimmed hat.

Money: 1D6×1000 credits.

Cybernetics: See above.

Ultra-Crazy O.C.C.

a.k.a. the TW Crazy

Argentina was the place where **M.O.M. Works**, the infamous "Crazy Conversion" was first developed. The original research centers where this technology was developed (and continued to be developed, in fierce competition with Germany's Mindwerks Corporation — see *Rifts® Sourcebook Two: Mindwerks™*), survived the Rifts with only minor damage. A team of researchers from Santiago found it and rebuilt it from the ground up. One of the researchers, **Professor Nostradamus Cervantes**, was a full-fledged Techno-Wizard, obsessed with the search for the ultimate soldier. Cervantes believed that normal Juicers and Crazies could not compete with monsters with supernatural strength; even a Crazy in full armor only had a prayer of surviving a hand to hand fight with a gargoyle, brodkil, pucara giant or supernatural predator. Already an authority in normal Crazy Conversion,



Cervantes worked side by side with a team of experts, combining magic, technology and psionic powers to augment human volunteers.

Many of the experiments were conducted in secret; if the Santiago government ever discovers the truth about the number of "accidental deaths" that occurred in the M.O.M. Research Center, a number of people would be arrested and tried for murder. Many would-be Crazies became catatonic, lost their lives, were possessed by supernatural entities (and had to be destroyed) or went berserk, also necessitating their destruction. It took years, but by 93 P.A., the first Techno-Wizard M.O.M. system was finally developed. Prototypes were quickly followed by standard systems, and by 100 P.A. there were over 3,000 TW Crazies in Santiago and other smaller kingdoms, many of them serving in the Santiago armed forces in the **Special Legion**.

TW Crazies, also known as "Ultra-Crazies," are minor or major psionics who underwent M.O.M. conversion. The brain implants are magically-powered, altering and mutating the make-up of the character's brain. The resulting super-psychic energies emanating from the mutated brain (which incidentally turns the crazy into a master psionic) also transforms the body, giving the person supernatural strength and endurance (becomes an M.D.C. creature). The Ultra-Crazy becomes a true superhuman, able to go toe to toe with hatchling dragons and other monsters without fear, needing nothing but his bare hands to destroy them!

There are after-effects, however. The damage to the character's mental stability is just as pronounced as in the normal Crazies. Even worse, many TW Crazies eventually develop the delusion of *Power by Association*, and with magic, belief is reality! As a result, TW Crazies literally lose their powers (become S.D.C. creatures) when the conditions for the use of their powers are not present. The same happens when characters are affected by phobias and other psychological disorders. This problem has prevented TW Crazies from becoming more common in Santiago.

The Powers of the TW Crazy:

1. Supernatural Endurance: The Ultra-Crazy becomes a supernaturally tough creature, able to withstand M.D. weapons! Physical M.D.C.: $3D6 \times 10$ plus P.E. attribute. Add $2D4$ M.D.C. per level of experience.

2. Supernatural Strength: Add $2D4$ to P.S. attribute (minimum 17). This is supernatural strength, enabling the character to inflict mega-damage with punches and kicks.

3. Supernatural Speed: Add $5D6$ to the Spd attribute. Can leap 30 feet (9.1 m) across after a short run (half from a dead stop) and 20 feet (6.1 m) high (half without a short run).

4. Heightened reflexes and agility: +4 to roll with punch, fall and impact, +2 on initiative, add one extra attack per melee, and add $1D6$ to P.P. attribute (minimum P.P. 17).

5. Supernatural Senses: The TW Crazy gains nightvision (200 feet/61.0 m range, able to see in complete darkness), exceptional long-range vision (can read a small sign or recognize a face as far away as two miles/3.2 km away). The character can also see the invisible! Enhanced sense of smell enables the character to instantly recognize odors (65%), recognize a person by scent (25%) and even track by smell (30%). Enhanced sense of touch adds +5% to skills that require a very delicate touch, such

as both demolition skills, pick pockets, pick locks, palming, electronics, etc.

6. Saving throw bonuses: +2 to save vs magic and psionics, +6 to save vs mind control (psionic, chemical and magical), +4 to save vs toxic gases, poisons and drugs.

7. Enhanced Healing: Heals at the rate of $2D6$ M.D.C. per hour; +10% to save vs coma/death.

8. Super bio-regeneration: A supernatural version of the Crazy's normal healing power, and very similar to the regenerative powers of dragons and other supernatural beings. The Crazy must stop to slip into a meditative trance. While in the trance, he is completely helpless and cannot move or take any action. All of his concentration is being focused into an accelerated bio-feedback program that restores $1D4 \times 10$ M.D.C. per melee round! This power can be used until the Ultra-Crazy is fully healed, but during that time he is vulnerable to attack.

9. Psionic Powers: Select a total of six psionic powers from any category except super. Plus select an additional psionic power from any category (including super) at levels three, five, seven, nine, eleven and thirteen. **I.S.P.:** M.E. $\times 5$ plus $2D6$ per level of experience.

10. Suffers from delusions and insanity: Like the regular Crazy, the character suffers from increasingly more intense insanities as time goes on. Furthermore, characters suffering from phobias and/or *power by association* may actually lose their powers when confronted by things they fear or when deprived of the "source" of their power! A roll vs insanity/psychic attack (12 or higher) is needed to avoid this loss.

Crazies who fail this save lose all combat bonuses, heightened senses and their M.D.C. and supernatural P.S. (M.D.C. is temporarily halved!). For example, an Ultra-Crazy confronted with a phobia for snakes finds himself facing a Serpentooid mutant! If the character makes his save against insanity, he only suffers the normal effects of being exposed to something he fears (see *Rifts RPG*, page 20); if he fails, however, he loses his Crazy powers! Likewise, an Ultra-Crazy who believes he derives his power from the sun (or a trinket, etc.) will lose his powers (no save) when the sun goes down (or if the trinket is lost or taken away).

Ultra-Crazies are trained to operate in the wilderness and the plains where most of the enemies of Santiago are located. Small scouting units made up of Ultra-Crazies can be found patrolling the areas between the cities of Santiago, often riding on horsebogs or horse-bots, on the prowl for raiders, monsters and invaders.

Alignment: Any, but tend to be unprincipled and anarchist.

Attribute Requirements: None, other than a willingness to subject oneself to this unusual magical treatment.

P.P.E.: $1D6 \times 10$

O.C.C. Skills:

Language: Spanish (98%)

Literacy: Spanish (+15%)

Radio: Basic (+10%)

Acrobatics (+10%)

Climbing (+15%)

Prowl (+20%)

Land Navigation (+10%)

Horsemanship (+15%)

W.P. Ancient (choice of two)

W.P. Modern (choice of two)

W.P. Energy Rifle

Hand to Hand: Martial Arts (or Assassin if evil)

O.C.C. Related Skills: Select six other skills. Plus select one additional W.P. and two skills at level three, two at level six and one at levels nine and twelve. All new skills start at level one proficiency.

Communications: Any (+5%)

Domestic: Any

Electrical: Basic Electronics only.

Espionage: Any (+10%)

Mechanical: Automotive and locksmith only.

Medical: Paramedic and holistic only.

Military: Any (+5%)

Physical: Any (+10% where applicable).

Pilot: Any

Pilot Related: Any

Rogue: Any (+5%)

Science: Any

Technical: Any (+5%)

W.P.: Any

Wilderness: Any

Secondary Skills: The character also gets to select four secondary skills from the previous list. These are additional areas of knowledge that do not get the advantage of the bonus listed in parentheses. All secondary skills start at the base skill level. Also, skills are limited (any, only, none) as previously indicated in the list.

Standard Equipment: A suit of mega-damage body armor, a set of riding clothing, a black or camouflage jump-suit for covert operations, two ancient weapons of choice, a vibroblade of choice, two energy weapons of choice and four E-clips for each, survival kit, camp knife, and either a horse borg or horse-bot, or a light personal vehicle.

Money: Starts with 1D4×1000 in credits.

Cybernetics: None, other than M.O.M. Cybernetics. Other cybernetics are avoided, because they may interfere with the magic abilities of the Ultra-Crazy.

Blood Rider O.C.C.

This elite group of riders is most common in the more tolerant republics of the continent. Blood Riders are human psychics who have managed to form a telepathic link with a D-Bee race of semi-intelligent carnosaurs (see the **Blood Lizard R.C.C.**). Through this link, the Blood Riders are the ultimate cavalymen, matched only by the Simvan monster riders in skill and ability. The Riders are also masters in the arts of survival, tracking and concealment, and make excellent guerrilla fighters, raiders and scouts.

Becoming a Blood Rider is a difficult and risky process. There are families and clans of Riders who breed their alien mounts. The children of these clans are screened for psionic powers; the vast majority, about 70% of all the progeny of each clan, lack the ability to become a rider (note that the percentage of riders among Blood Rider clans is much higher than among the population as a whole). The "normals" are trained as normal horsemen and warriors such as the *Gauche O.C.C.* The rest can work and take care of the Blood Lizards; the creatures will not

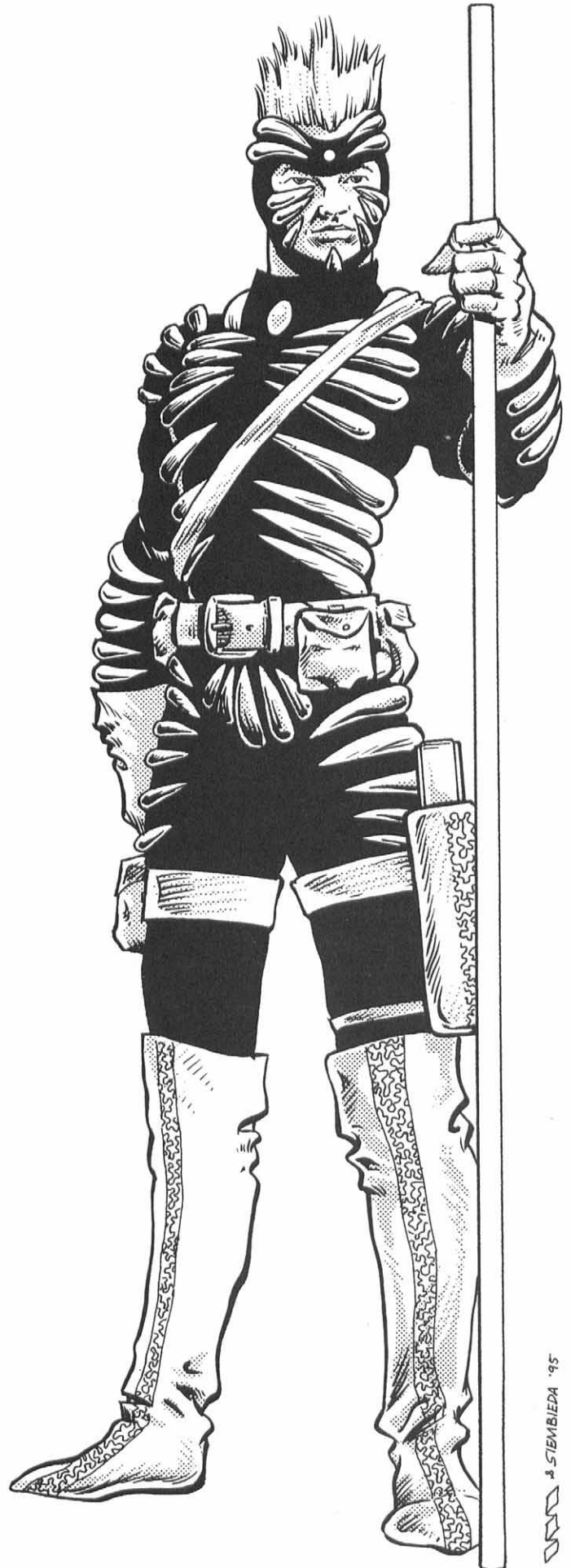

trust or befriend any non-psychics, and are likely to attack any “outsiders.” This is a reason why only Blood Rider clans keep Blood Lizards in large quantities. As they grow up, the young psychics try to forge a psionic link with the creatures under their care. The attempts are often risky, because the carnasaurs may be enraged by the telepathic contact, and attack the apprentice. Every year, all the clans lose at least one or two apprentices this way.

Eventually, however, the Blood Rider will manage to link up with one Blood Lizard. Although linking up with more than one lizard is possible, the clans only allow beginners to become bonded with one mount. This is both because the lizards are expensive and rare and due to the fact that two or more Blood Lizards bonded to the same rider become extremely jealous of each other and fight, often to the death. Only a very experienced rider can manage a “pack” of Blood Lizards, and even then he can only use his psychic bond with one at a time. Most Blood Riders will never even attempt to bond to more than one.

The Blood Rider clans train both males and females; psionic powers are too rare and precious among the clans to let machismo get in the way. Besides riding, the trainees are taught the ways of combat, tracking and surviving in a hostile environment. The Blood Riders can do anything from lizard-back, including eating, shooting, reloading and even sleeping! Many bad jokes are made about the riders, who are often believed to never dismount. The Blood Riders usually ignore the jokes of the “land rats” as they call outsiders and like to think they are above such petty jealousies.

Clan members often sell their services as couriers, bodyguards and scouts. Any pay received for such assignments is divided evenly between the Blood Rider and his/her clan. The clans get the rest of their income from cattle ranching (each clan owns a vast expanse of territory, where they raise cows, horses and other animals). The clans operate in the plains of Santiago and a few small Silver River Republics, with the exception of Cordoba, where they are persecuted for consorting with “demonic monsters.” In Santiago, all clan members are official members of the militia, and are on call in case of invasion. Patrols made up of regular gauchos, plains borgs, Blood Riders and the occasional Juicer, Crazy or Ultra-Crazy are often sent out after Larhold Barbarians. When the transdimensional barbarians and these motley groups meet there is always bloodshed and carnage.

Two Blood Rider clans also live in the Achilles Republic. The mutant animals in the area respect them, and feel a degree of kinship due to their psychic abilities. The Blood Riders and the Psi-Taurs often compete against each other in friendly sporting contests.

O.C.C. Abilities and Bonuses:

1. Psychic Link to Blood Lizards: The character is psionically bonded to his mount. This telepathic and empathic link allows both the rider and lizard to see through each other’s eyes, to feel each other’s emotions, and to communicate in an instant, precise way. The Blood Rider has a base riding skill of 78% (add 3% per additional level of experience) with the lizard he’s bonded to. **Range of the mental link:** 100 feet (30.5 m) per level of experience.

2. Psionic Powers: All blood riders are major psionics. Select powers as appropriate (see *Rifts RPG*, page 12). Determine I.S.P.

as normal. Master psionics (a mere 1% of all Blood Riders) use the Master Blood Rider R.C.C., described below.

3. I.S.P. Reservoir: Blood Riders can draw on the I.S.P. of their mounts (1D6×10+10 or more). While the Blood Lizard will usually be glad to share, draining one’s mount of energy is considered to be mistreatment, and most Blood Riders will never drain more than half of their animal’s I.S.P.

4. Other Bonuses: Due to their extreme physical training, Blood Riders get a +1 to P.S. and P.E., +1D6 to Spd and +3D6 S.D.C. While fighting on lizard-back, Blood Riders are at +1 to strike and parry (the lizard positions itself to give the rider the best shot/attack possible). As long as rider and mount are within 100 feet (30.5 m) of each other, both of them are at +3 to save vs psionics, possession, horror factor, magical charms and mind control (these particular bonuses are not applicable when the two are apart).

Alignment: Any; but typically their alignment reflects a deep sense of loyalty towards their clan and their mount (aberrant if evil, unprincipled if selfish, principled if good).

Attribute Requirements: High M.E. and P.P. (10 or higher).

O.C.C. Skills:

Language: Spanish (98%)

Literacy: Spanish (+15%)

Radio: Basic (+10%)

Horsemanship (+15% to horses & horse-like animals)

Horsemanship: Exotic Animals (+25% with blood lizards, +15% with other exotic riding animals).

Wilderness Survival (+20%)

Tracking: Animals (+15%)

Tracking: Humans (+15%)

Land Navigation (+10%)

W.P. Energy Rifle

W.P. One archaic weapon of choice

W.P. One of choice

Hand to Hand: Expert

Hand to Hand: Expert can be changed to Hand to Hand: Martial Arts (or assassin if evil) at the cost of one “other” skill.

O.C.C. Related Skills: Select six additional skills. Plus the character gets to select two skills at level three, and one at levels six, eight, eleven and fourteen. All new skills start at level one proficiency.

Communications: Any

Domestic: Any (+5%)

Electrical: Basic Electronics only.

Espionage: Detect ambush, detect concealment and sniper only(+5%)

Mechanical: Automotive mechanics only.

Medical: First aid only.

Military: None.

Rogue: Any (+5%)

Science: Astronomy only.

Technical: Any (+10%)

W.P.: Any

Wilderness: Any (+10%)

Secondary Skills: The character also gets to select two secondary skills from the previous list at levels one, three and seven. These are additional areas of knowledge that do not get the advantage of the bonus listed in parentheses. All secondary skills start at the base skill level. Also, skills are limited (any, only, none) as previously indicated on the list.

Standard Equipment: Blood Rider "Claw" Armor (M.D.C. 65), one energy weapon of choice and four E-clips, vibroblade of choice, three archaic or non-energy weapons of choice, riding cloak, two sets of traveling clothes, one set of fine clothes for public events, saddle, Blood Lizard riding animal, and camping kit.

Money: 1D4×1000 credits.

Cybernetics: None to start with. Avoid them for fear of interfering with their psionic powers.



Master Blood Rider R.C.C.

These near-legendary riders are master psionics who, in addition to their link to blood lizards, have great psionic powers. Most of the time, the clan keeps this power a secret, because many humans already fear and distrust them as D-Bees. The discovery that a small percentage of the Blood Riders have super-powerful psionic abilities could lead to persecution.

Within the clans, however, all members do their best to honor and train these powerful people, while at the same time instilling feelings of loyalty and responsibility towards their clan, all Blood Riders, and humanity; in that order. Their training is more strenuous and intense than the normal Blood Rider, because the Masters are expected to be the best, and also need more time to hone their greater psionic abilities. The pressure and expectations placed on the youngsters are very intense; some of them snap and run away, fail on purpose, or even commit suicide!

Others carry on, but end up bearing an intense hatred for their own clans, or a sense of contempt for all who do not share their powers. Most, however, manage to weather both their harsh training and the occasional jealousy and hatred from young Blood Riders, and eventually rise to greatness.

Most Masters end up finding a cause or overriding objective, and devote their lives to it. Such a cause can be something as simple as "protect my clan from all enemies," or as complex and difficult as "save the entire region from the evil of the Larhold Barbarians." Good or evil, the Master Blood Riders will be totally dedicated to achieving their goals. In the past, these leaders have tried to unify all clans and establish a homeland, or led their clan into dangerous, sometimes suicidal battles. Others have left their people behind, and become champions of greater causes and all people, for good or ill.

O.C.C. Abilities and Bonuses:

1. Psychic Link to Blood Lizards: The character is psionically bonded to his mount. This telepathic and empathic link allows both the rider and animal to see through each other's eyes, to feel each other's emotions, and to communicate in an instant, precise way. The Master Blood Rider has a base riding skill of 81% (add 3% per additional level of experience) with the lizard he's bonded to. **Range of mental link:** 150 feet (45.8 m) per level of experience.

2. Psionic Powers: Master psionic. At first level, the character has the following powers: mind block, telepathy, levitation, telekinesis, telekinesis (super), telekinetic levitation (special), and personal telekinetic force field (special).

Additionally, select two powers from each of the healing, physical and sensitive categories. Also select an additional two powers from any category (including super) upon reaching a new level of experience. Psi-sword cannot be taken until reaching third level.

Telekinetic Levitation (Special): While riding his mount, the Master Blood Rider can telekinetically levitate himself and his animal! This special power lasts one minute per level of experience, and costs 10 I.S.P. While activated, the Blood Lizard mount can leap five times its normal distances, increases its speed by 50% and can actually run in the air at its normal speed! Most of the time, the Master will use this power in subtle ways, to prevent revealing himself; thus, his mount will leap over chasms, run extremely fast, and perform amazing but not incredible feats. The running on air/flying power is only used in emergencies, when no witnesses are around, when among trusted friends, or to terrify and intimidate one's opponent(s).

Personal Telekinetic Force Field (Special): This is a variation of the standard Telekinetic Field. The character can surround himself with a skin-tight, invisible force field that protects with 35 M.D.C. per level of experience. This force field can only be activated if the character is within 100 feet (30.5 m) of his Blood Lizard mount. The force field lasts 10 minutes per level of experience and costs 35 I.S.P.

3. I.S.P.: The character is a master psionic with 3D4×10 I.S.P. plus the M.E. attribute number. Add an additional 2D6 I.S.P. per level of experience.

4. I.S.P. Reservoir: Master Blood Riders can draw on the I.S.P. of their mounts (1D6×10+10 or more). While the Blood Lizard will usually be glad to share, draining one's mount of all psychic energy is considered to be mistreatment, so most characters will never drain more than half of their animal's I.S.P.

5. Other Bonuses: Due to their extreme physical training, Master Blood Riders get a +2 to P.S. and P.E., +4D6 S.D.C., +2 to pull punch, +2 to roll with impact or fall, and +4 to save vs horror factor. While fighting on lizard-back, Master Blood Riders are at +2 on initiative, and +1 to strike and parry (the lizard positions itself to give the rider the best shot/attack possible). As long as rider and mount are within 100 feet (30.5 m) of each other, both of them are at +4 to save vs psionics, possession, magical charms and mind control.

Alignment: Any; typically their alignment reflects a deep sense of loyalty towards their clan and their mount (aberrant if evil, unprincipled if selfish, principled if good).

Attribute Requirements: High M.E. and P.P. (10 or higher).

O.C.C. Skills:

Language: Spanish (98%)

Literacy: Spanish (+20%)

Radio: Basic (+10%)

Horsemanship (+10%)

Wilderness Survival (+20%)

Tracking: Animals (+15%)

Tracking: Humans (+20%)

Land Navigation (+10%)

W.P. Energy Rifle

W.P. One archaic weapon of choice

W.P. One of choice

Hand to Hand: Expert

Hand to Hand: Expert can be changed to hand to hand: martial arts (or assassin if evil) at the cost of one "other" skill.

O.C.C. Related Skills: Select six additional skills. Plus the character gets to select two skills at level three, and one at levels six, eight, eleven and fourteen. All new skills start at level one proficiency.

Communications: Any

Domestic: Any (+5%)

Electrical: Basic electronics only.

Espionage: Detect ambush, detect

concealment and sniper only (+10%)

Mechanical: Automotive mechanics only.

Medical: First aid only.

Military: None.

Physical: Any (+5% if applicable).

Pilot: Any (+5%)

Pilot Related: Any (+5%)

Rogue: Any (+5%)

Science: Astronomy only.

Technical: Any (+10%)

W.P.: Any

Wilderness: Any (+10%)

Secondary Skills: The character also gets to select two secondary skills from the previous list at levels one, three, six and nine. These are additional areas of knowledge that do not get the advantage of the bonus listed in parentheses. All secondary skills start at the base skill level. Also, skills are limited (any, only, none) as previously indicated on the list.

Standard Equipment: Blood Rider "Claw" armor (M.D.C. 65), one energy weapon of choice and four E-clips, vibro-blade of choice, three archaic or non-energy weapons of choice, riding cloak, two sets of traveling clothes, one set of fine clothes for public events, saddle, Blood Lizard riding animal and camping kit. There is a 30% chance that a beginning Master will have a techno-wizard weapon or an additional energy weapon (roll for each).

Money: 1D6×1000 credits.

Cybernetics: None to start with. Will not get any implants except for medical reasons, for fear of interfering with their psionic powers.

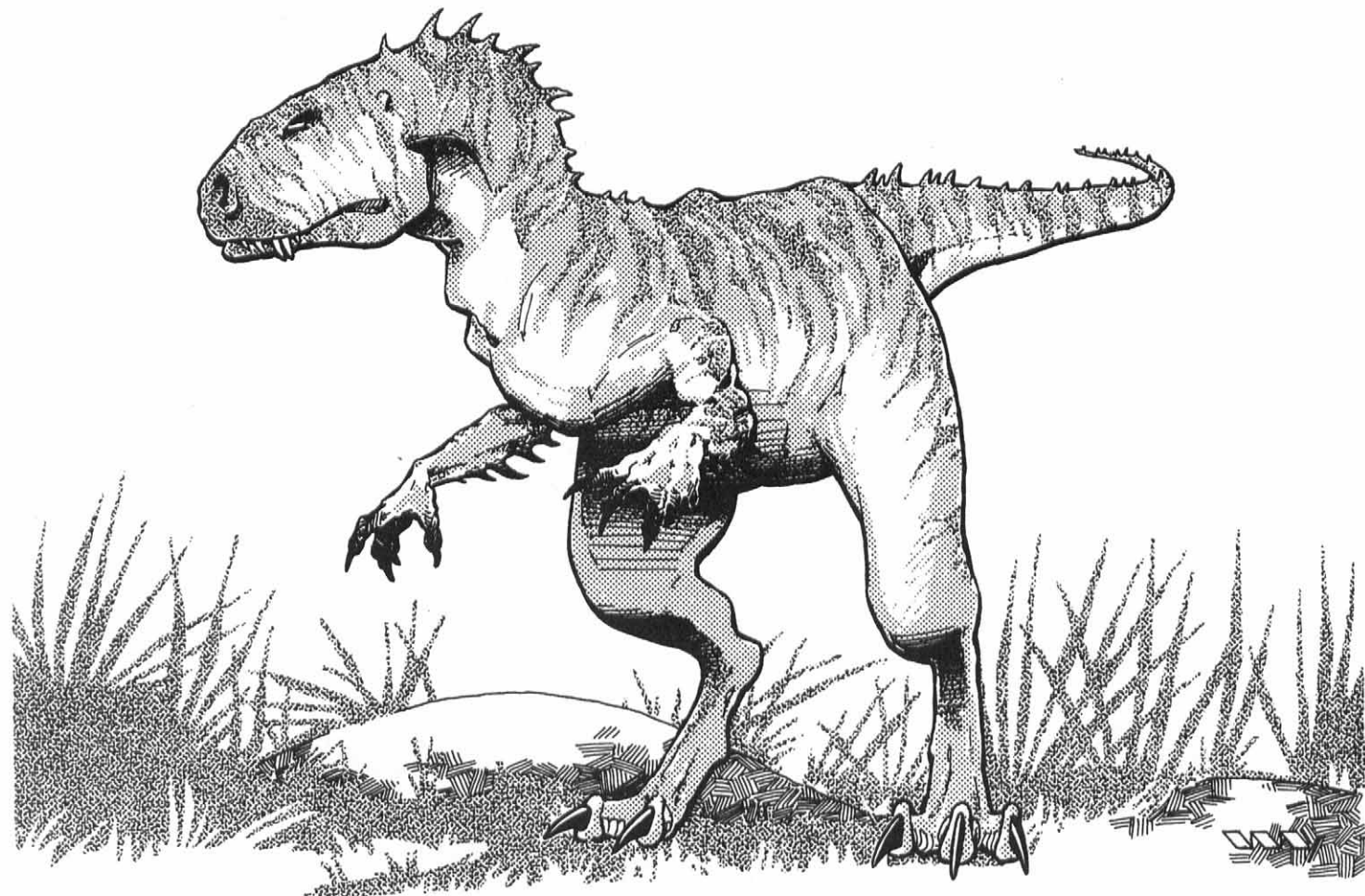

Blood Lizard R.C.C.

Optional Player Character

Blood Lizards are a D-Bee race of intelligent psionic predators. Although at first glance, they look like prehistoric dinosaurs, Blood Lizards are far stronger and faster than the carnosaurs they resemble. Bipedal runners, Blood Lizards can use both their forepaws and hind legs to deliver brutal slashes, and their long snouts/mouths have sharp fangs able to tear through metal and concrete with ease. Despite their appearance and apparent lack of technology, the Blood Lizards are not mindless predators. They are extremely intelligent, and are able to understand technology and even occasionally use it! Few sights are more terrifying than a Blood Rider shooting from the back of a Blood Lizard who is, itself, holding and using an energy weapon!

Like most intelligent animals, Blood Lizards do not enjoy being ridden like a herd beast. Only the Blood Riders can earn that privilege, because Blood Lizards count them as their friends and companions (a Simvan Monster Rider should be able to forge a similar bond, but no Simvan is known to have travelled this far south; they live in North America). The bond forged between the animal and its rider is almost always deeper than most friendships and even family ties. Each member of the symbiosis is ready to die to protect the other, or to cold-bloodedly avenge his death. "If you kill a Rider, you'd better kill his beast as well," is both a common saying and a warning; the Blood Lizard will spend the rest of its days tracking down and executing the killers of its friend.

In addition to their intelligence, speed, lethality and strength, Blood Lizards have great tracking abilities, using both their sharp senses and their psychic abilities to find their quarry. Together with their skilled rider, they make the ultimate tracking team.

Game Master Note: Blood Lizards are intelligent beings, and could be used as player characters. The Game master should remind players that the creatures are quite different from humans in terms of goals and priorities. Role-playing one of these strange creatures can be a challenging but interesting choice.

Alignment: Most are aberrant or anarchist; will do anything for its rider but rarely cares about the welfare of others.

M.D.C.: 3D6×10+20

Attributes: I.Q. 2D4+4, M.E. 3D6, M.A. 2D6, P.S. 2D6+20, P.P. 2D6+12, P.E. 2D6+14, P.B. 2D6, Spd. 1D4×10+100 (110 to 140; roughly 75 to 100 mph/120 to 160 kmph). Attributes are considered to be supernatural.

Size: 8-10 feet (2.4 to 3.0 m).

Weight: 800 to 1200 lbs. (362 to 544 kg)

Horror Factor: 9

P.P.E.: 5D6

Average Life Span: 50 years

Natural Abilities: See psionic powers, below. Also can bio-regenerate 1D6 M.D.C. every minute, has exceptional vision, nightvision (1000 feet/305 m range) and is able to track by

smell 68% (usually by blood scent or other strong smell), recognize scent of rider 88%, and recognize others by scent 38%.

Experience Level: Varies. Average 1D4+1.

Combat: Natural skills. Three hand to hand or psionic attacks per melee to start; add an additional attack at levels five, nine and thirteen.

Damage: Claws or slashing tail do 1D6 M.D. in addition to supernatural P.S., bite inflicts 4D6 M.D., tearing leap kick 2D6 M.D. plus supernatural P.S., plus the beast can use hand-held weapons (vibro-blade, energy rifle, rail gun, etc.).

Bonuses: +3 on initiative, +3 to strike, parry and dodge, +1 to roll/pull punch, +5 to save vs horror factor, +2 to save vs psionics; all in addition to attribute bonuses.

Magic Powers: None.

Psionic Powers: Bond with rider (same as the power of the Blood Rider; see above). Additionally, Blood Lizards have the following psionic powers: empathy, telepathy, see aura, and see invisible. Considered to be a master psionic.

Psychic Tracking (Special): Blood Lizards can follow the psychic "trail" of any living being they've been in contact with. **Base chance:** 40% plus 3% per level of experience. Increase this by +10% if the target is a supernatural being; their auras are stronger and easier to track. The older the trail is, the more difficult it is to track; subtract 1% for every day that the quarry passed through the area. **Range:** 60 feet (18.2 m). **Cost:** Using this power costs one I.S.P. per 8 hours of tracking (cannot be recovered until the lizard does not try to track the quarry for a full day).

I.S.P.: 1D6×10+10, plus 2D6 per level of experience.

Vulnerabilities/Penalties: None, but dislikes cold and M.D. fire.

R.C.C. Skills: Keep in mind that most skills are not appropriate for Blood Lizards. The creatures are intelligent, but they have great difficulty understanding the written word (literacy counts as two skill selections, and cannot be chosen as a secondary skill), and most technological skills are beyond them.

Wilderness Survival (+20%)

Land Navigation (+20%)

Detect Ambush (+10%)

Swimming (+20%)

Climbing (+10%)

Prowl (+5%)

Language: One of choice, typically learned from Blood Rider (+10%). **Note:** This allows the creature to *understand* the language, not speak it. Blood Lizards communicate through telepathy; only Blood Riders and psychic characters with the telepathy or empathy powers can "hear" them clearly. The Lizard can communicate with others through gestures or psionically transmitted images and emotions/feelings.

R.C.C. Related Skills: Select four other skills. Plus select an additional skill at levels four, nine and fourteen. All new skills start at first level.

Communications: None

Domestic: Only sing, dance, and play musical instrument (-20%)

Electrical: None

Espionage: Detect concealment only.

Mechanical: None

Medical: None

Military: None

Physical: None, besides the ones above.

Pilot: None

Pilot Related: None

Rogue: Any, except computer hacking, but all are -10%.

Science: None.

Technical: Languages, literacy and lores only.

W.P.: Any.

Wilderness: Any, but all are at -10%.

Secondary Skills: Select two secondary skills, excluding those marked "none." These are additional areas of knowledge that do not get the advantage of the bonus listed in parentheses. All secondary skills start at base skill level.

Alliances and Allies: None besides Blood Riders and the occasional Simvan Monster Rider (see *Rifts Sourcebook One*).

Weapons and Equipment: Some Blood Riders give weapons to their mounts. Typically these are heavy energy rifles or rail guns. Also, a few wealthy Riders equip the lizards with armored barding; such a suit has A.R. 15 (protects only part of the body), has 100 M.D.C., and costs 80,000 credits. Most Blood Lizards have little else in the way of equipment.

The Achilles Republic

Mutant Homestead

Population Breakdown: 1.8 million (45% mutant animals, 35% humans, 20% assorted D-Bee races). There are three major cities in the Achilles Republic: Cordelia (pop. 230,000), New Neuquen (pop. 160,000) and Shieldtown (pop. 80,000). The rest of the population is scattered in villages, towns and small cities, usually under 10,000 people in size.

This free Silver River Republic is entirely controlled by mutant animals, a distinction it shares only with the hidden city of Omagua (see *Rifts South America: One*). Like Omagua, the Achilles Republic is the result of the forbidden experiments conducted by the Argentinean government, code-named **Project Achilles**.

The citizens of Achilles are fairly tolerant of other species, but are not necessarily better or nicer than their neighbors. After centuries of fighting for survival, many citizens have nothing but hostile feelings towards strangers. The Achilleans do not give their trust easily, and are always ready to assume the worst, especially of humans. In fact, many of them believe that the best way to prevent hateful anti-mutant factions from attacking them is to strike first and conquer and destroy potential enemies! Although the majority still do not advocate this policy, growing tensions and the threat of war with Cordoba looms grimly over them.

History

The Achilles Project had its origin in the climate of distrust and fear that permeated the planet shortly before the Coming of

the Rifts. It was inspired by an earlier project sponsored by ShaperCorp, a South American-based corporation specializing in genetic engineering. ShaperCorp was based in South America because of the lax laws regarding animal and human experimentation, and environmental issues. Secretly, ShaperCorp was manipulating the genetic codes of humans and animals to produce superior combinations.

However, one of the company's experiments involving humans and fish, was revealed, resulting in the so-called *Amphib Scandal* (for more information about the Amphib Scandal and what happened to the victims of those experiments, see *Rifts Underseas*). The Argentinean authorities arrested scores of researchers and executives at the facility, and the public uproar died down. Unknown to the rest of the world, however, the Argentineans decided to put the skills of ShaperCorp's researchers to good use. The scientists were offered freedom and money in return for their secret participation in the government sponsored *Project Achilles*. The government seized documents and research was quietly relocated and the ShaperCorp's people quietly put to work. This time, however, the goal was to produce several races of super-soldiers, augmented through genetic manipulations.

Note: Project Achilles was not the only genetic manipulation program in the world. Its largest competitor was an American government contractor, *Tex-Am*, which also tried to mix animal and human genes to produce super-soldiers. Tex-Am continues its work under the auspices of the Coalition States at Lone Star, and is responsible for the famous *Dog Boys* (only the most common, obedient and cheapest mutants to produce. Dozens, perhaps hundreds of different mutant animals continue to be created there, some with superhuman psychic and physical powers. The upcoming **Lone Star** supplement for **Rifts** will detail many of the mutations and experiments conducted by that Coalition State).

Over two dozen secret labs were built throughout Argentina, usually at isolated and inhospitable areas to prevent discovery and to make "escape" more difficult for the experimental subjects. Instead of volunteers, convicts, political prisoners and some randomly kidnapped people were used to provide the human genetic material. Animals of all types, both native to South America and imported from elsewhere, were used by the thousands. One laboratory specialized in feline-human creatures and its work would lead to the creation of the Omagua mutants described in *Rifts World Book Six: South America (One)*. The other labs were less successful, but made up for it by the number and variety of their creations.

Early on, scientists had discovered some animal strains had latent psychic abilities, and the combination with human genes seemed to activate and enhance those powers. Eventually, all the creations of Project Achilles possessed some degree of psionic power.

When the Great Cataclysm struck, the military directors of the project thought that a nuclear war had erupted. Orders in such an eventuality were to "terminate" the experiments. However, one scientist, a brilliant young woman named *Cordelia Valdez*, could not bear the thought of massacring the thousands of mutant animals that had been created. Not only had she come to think of them as people, with the same hopes, fears and feelings as anyone else, she had used her genes in the most ambi-

tious experiment in the project: a completely humanoid mutant with incredible psionic powers. Her "babies" were still in the embryonic stage; as she heard the orders to inject every mutant animal with a fast-acting poison, she decided to act. Using her security clearances, she managed to free a number of the mutant animals, and with their help she managed to take over the largest research center in the area, where over two dozen mutant strains had been developed. Under the circumstances, seizing the facility was easy. With all the frightening storms, disasters and dimensional anomalies of the Great Cataclysm, few workers, police or other authorities cared about what happened to the facility — it was every man for himself.

Miraculously, Cordelia and the newly-liberated mutants managed to survive the Great Cataclysm. Many of the psychic powers of the mutant animals became enhanced and reached supernatural levels. With those powers, the former research subjects were able to defend themselves and the facility. A motley group of humans, mutants and, later, even some D-Bees, were able to establish a small town near the ruins of the city of Neuquen. The new town was renamed Cordelia, in honor of the human researcher. Cordelia Valdez died in childbirth less than a year after the establishment of the city. To save one of the embryonic mutants, she had actually carried it to term in her own body! Her sons (Cordelia bore triplets) were the first of a new line of "neo-humans," fully humanoid mutants with greatly enhanced psychic powers.

It took over a hundred years, but the struggle to survive has been successful, and Cordelia became a strong city-state. By the year 18 P.A., the Achilleans had expanded and established two more cities, one built by colonists from Cordelia, the other absorbed by treaty (and the threat of war). That last city was a human independent kingdom that was about to be overrun by forces from Cordoba. The Achilleans offered the city protection in return for accepting the republic's government. The city council agreed, and the mutant animals routed the Cordoban army in the *Battle of the Red Storm*, so called because a group of powerful mutants used their powers to initiate a ley line storm among the Cordoban soldiers!

Since that battle, the mutant's Republic has become a full-fledged nation, a place where humans, mutants and D-Bees live together. Total harmony, however, remains an elusive goal.

Government and Society

The Achilleans have a republican government. In the cities, elections are held to determine who will sit in the Animal House, the Achillean representative body (some historians believe the name was some sort of inside joke by the founders). **The House** (referred to as "the Zoo" by some anti-mutant groups) elects a Director, who acts as moderator of the House's debates and also has some special powers in case of emergencies. There is also a **Military High Command**, whose Commander in Chief is also selected by the Animal House. During emergency situations, the High Command acts on its own, without waiting for instructions from the Animal House —but the actions of the military are then judged by the House. Although the system could be perverted (by using a false state of emergency to seize power), so far it has worked in a fair and equitable way.

All citizens have the right to vote. Even people living in remote areas can vote, if they feel up to traveling up to ten miles

(16 km) to the nearest government/military post. For the most part, however, mutant animals are the most active in political life. Many of the human citizens are very apathetic (less than 50% bother to vote) because they think the government is firmly in the hands of the mutants, and that there is nothing they can do to change it. On the average, only 10% of the members of the Animal House are normal humans; an additional 8% is made up of D-Bees.

Mutants hold most of the important positions in the government, the military, and the business world. Although discrimination and abuses toward humans are not common or overt, there is a clear "understanding" that Achilles is a mutants' nation. Discrimination against humans is not obvious, but it does exist, even if it is disguised as "common sense." Since many mutant animals are stronger, faster and tougher than normal humans, and have psychic powers to boot, they can often do things better and more easily. Thus, even if competing fairly, the mutant animals will sometimes beat human candidates and get the better paying jobs or higher positions of authority. Many humans are just happy to live in a place where they are protected from the dangers of Rifts Earth, and do not care about who is their boss or supervisor. A slowly growing minority is extremely angry and frustrated with the situation. Some have become terrorists, forming small groups similar to or even associated with the insidious **Sendero Luminoso** (the *Shining Path*, described elsewhere in this book). Others have in the past, betrayed their country to Cordoba and other enemies. Some mutants have seen those betrayals as proof that all humans are not to be trusted, despite the fact that the majority of the human population is loyal or at worst, indifferent towards Achilles' affairs. Tension is mounting between humans and mutants.

Armed Forces

The Achilles Army is a motley combination of mutants with superhuman powers and high-tech soldiers with cutting-edge equipment. Most of the Achilleans' advanced weapons and vehicles are purchased from New Babylon. Achilles, itself, has a relatively low level of technology (at best the equivalent of early 20th Century America). No manufacturing facilities for nuclear power plants, robots, power armor, and similar sophisticated industries have been established in the country. The major cities have facilities to repair and resupply such machines, and they also manufacture energy weapons, conventional vehicles and less complex devices, but they are backward compared to Cordoba, and they know it.

To make up for this technological gap, the Achilles Army relies heavily on psychic powers. Some of the mutant animal species, especially the serpentoid, psi-taur, condoroids and neo-humans, have super-psionic powers that enable them to match soldiers in robots or power armor. Every squad has at least one powerful psychic among its members, and special squads made up exclusively of these beings are present in all company-sized units and sent on special missions. Neo-Humans are so few in numbers that they are used in special teams; their ability to infiltrate human groups makes them ideal spies and saboteurs.

All mutant animals serve in the Army. A mandatory term of service is four years for every mutant citizen. Humans and D-Bees must also serve, but only for two years. Most of the perma-

nent, professional army is made up of mutants, as is 70% of the officer corps. Human and Amaki military advisors from New Babylon often fight side by side with the Achilleans.

Foreign Relations

Cordoba: This human nation is Achilles' worst enemy. Since the two nations came into contact, battles and outright wars have plagued their borders. There is a "no man's land" strip separating the two nations; this stretch of land, running almost the entire border, is full of mines, traps and obstacles. On each side of this buffer zone are military bases and forts spread along the entire front. At least once every couple of months, one side or the scale skirmishes, but sometimes they escalate into major battles. Travelers trying to cross the borders risk being attacked by one or both sides.

The only safe way to travel between Cordoba and Achilles is by water. Independent merchant ships from the **Southern Federation** are allowed to travel up the Greater Amazon River unmolested. Mutant animals are not allowed into Cordoba, however. Passengers must remain aboard the ship until they leave that country's territory. Sometimes, mutant passengers are seized, arrested or even killed, but this rarely happens, because Cordoba does not want to jeopardize their relationship with the Southern Federation.

The Coalition/Lone Star: To the surprise of many travelers (including Professor Cudbury himself), the Achilles Republic has been visiting the Coalition States, especially Lone Star, for quite some time! Rumors of a "mutant homeland" have reached as far as North America. Volunteer teams called the *Freedom Riders* often make raids and incursions into Coalition territory, seeking to liberate the mutant animals at the Lone Star CS State.

The Freedom Riders typically use ships or aircraft to make the treacherous journey between the continents. These trips avoid populated areas and the worst dimensional anomalies in the open seas; even so, as many as 30% of those expeditions are annihilated in transit. Once they make it to Lone Star, the Achilleans try to locate and convince the many mutants from that land to abandon their former masters and join up with them!

In Lone Star, a surprising 60% often refuse for various reasons. In some cases, like the Dog Boys, this is due to the generally good treatment they enjoy in the State. For others is it family ties, the fear of their tyrant masters, or just the fear of the unknown. Many, especially escaped refugees, find the lure of a mutant homeland is enough to make them abandon their fears and seek a new life in Achilles. These journeys, to and from Lone Star, are fraught with danger, both from the Coalition authorities, which will not tolerate such invasions, and from travelling through inhospitable and monster-ridden regions. **Game Master's Note:** In short, Freedom Riders make excellent adventures or even the backdrop of an entire campaign. Don't forget that Mexico and the Yucatan Peninsula (Central America) are the domains of vampires and monsters.

As a result of the Freedom Riders' activities, the Coalition was aware that a nation of mutant animals existed somewhere in South America. Through its growing diplomatic relations with Cordoba, the CS now has a great deal of information about that nation. The forces at Cordoba have diplomatically encouraged the Coalition to take (covert) punitive action against these "dangerous mutants and rebels," and have offered to help support any

such expedition with the Cordoban army! The CS is seriously considering this “generous” offer and is likely to take some sort of action in the future. For the moment, this will have to wait until other problems closer to home (such as Tolkeen) are settled.

The Arkhon Freehold: The Arkhons sometimes make forays into the Achilles Republic. For the most part, the alien invaders have not antagonized the mutant homeland. Some Achillean mutants look at this as a sign of respect and believe they have more in common with the vaguely animal-like aliens than with humans. What this all means, is that under the right set of circumstances, an alliance between the Arkhons and the mutant animals is possible, especially if a conflict involved Cordoba.

The Larhold Barbarians: These nomadic barbarians have travel routes right through the Achilles’ territories. Raids and even full-scale assaults against villages and towns are common. The Achilles army and special assault teams spend just as much time fighting these barbarians as they do dealing with Cordoba.

Omagua, City of Felines: This mythical city is ruled by three feline gods, and is populated by mutant felines. These felineoids were the product of the same experiments that produced the mutants that inhabit Achilles! Unfortunately, there is no contact between the two nations of mutant animals; Omagua is hidden, a myth that the Achilleans have heard of but never seen. **Note:** Omagua is fully described in *Rifts® World Book Six: South America: One*.

R.C.C.s & O.C.C.s of Achilles

In addition to the special breeds of mutants described below, dozens of other mutant animal breeds live in Achilles. Hundreds of dog boys and other mutant animals from Lone Star have migrated to this land; any of the mutant animals described in the *Rifts® RPG*, *Rifts® World Book One: Vampire Kingdoms™* and the upcoming *Lone Star World Book* can be found in this area; more animal creatures can be taken from *After the Bomb®* supplements and *Teenage Ninja Mutant Turtles® and Other Strangeness*. Mutants, both humanoid and animalistic, can also be found and converted from *Heroes Unlimited™*.

Serpentoid R.C.C.

A few of the most ruthless researchers at Project Achilles went beyond the “normal” limits of genetic manipulation. Eschewing mammals like cats, canines and horses, they mixed the DNA of humans with that of reptilians, snakes in particular. Some scientists believed that some of the fear and fascination induced by snakes on most other animals was psionic in origin. They thought that by blending human and serpent genes they would create not only a superior humanoid, but would also provide him/her with powerful psi-abilities. The scientists concentrated on poisonous predators: cobras, rattlesnakes and vipers. The final strain developed had the cobra as the dominating species (including the distinct head shape).

Although there are some variations between individuals due to genetic aberrations, 80% of all serpentoids are humanoid beings. The snake “body” becomes an elongated tail and neck, and their spines bulge outward from their back — the impression is of a snake body grafted to the back of a human torso, arms and legs. The head is totally snake-like, with a cobra’s flaps on the sides. The mutants tend to be lean and wiry, but have incredible strength, boosted psionically to be equal to supernatural creatures.

The experiments had succeeded beyond any expectations. The few “serpentoids” had tremendous empathic powers, and could surround themselves with a psychic energy field that made them bullet-proof. With the increase of psychic energy on Rifts Earth, the psionic energies became M.D.C. capable, tough enough to shrug off any damage short of heavy military weap-

ons. The psychic energies also increased the strength of both the serpentoids’ body and their venom. Regrettably, the alien mind-set of a reptilian affected the minds of most serpentoids; their cold detachment allows them to commit the worst murders without feeling any compassion or guilt. Most serpentoids learn to follow a code of honor or the law of the land, and thus can be expected to respect the lives and properties of their fellow Achilleans, even if they are human. When fighting the enemies of their country, however, many unsupervised serpentoids kill and torture with a clear conscience, as do miscreant criminals.

Alignment: Any, but about 50% of all serpentoids are aberrant. They tend to lack empathy and compassion, but are fiercely loyal to those they consider their friends.

M.D.C.: When their force field is activated, serpentoids effectively become M.D.C. creatures with M.E.x5 M.D.C. plus 10 M.D.C. per level of experience.

S.D.C.: 4D6x10 plus skill bonuses, if any.

Hit Points: P.E.x2 plus 2D6 per level.

Attributes: I.Q. 3D6+4, M.E. 2D6+12, M.A. 2D6+10, P.S. 2D6+20, P.P. 3D6+6, P.E. 3D6+6, P.B. 3D6, Spd. 4D6. Strength becomes supernatural when surrounded by the force field.

Size: Average 6 feet (1.8 m) not counting the tail (adds another 4 feet/1.2 m).

Weight: Average 180 lbs. (81.5 kg)

Horror Factor: 8; higher if special powers are used (see below).

P.P.E.: 4D6

Average Life Span: 100 years.

Natural Abilities:

1. **Psionic Force Field:** By spending 10 I.S.P., the serpentoid can surround himself with a force field that protects with an M.D.C. equal to the Mental Endurance attribute (M.E.) times five. Add 10 M.D.C. per level of experience. While the force field is on, the serpentoid has the equivalent of supernatural strength in terms of damage and carrying capacity (see *Rifts Conversion Book One*, pg. 22, for details). The field will last either until all M.D.C. are depleted or one hour per level of experience.

2. **Entrancement Gaze:** If the serpentoid spends 15 I.S.P. and makes eye contact with somebody (maximum range 100 feet/30.5 m), the victim will become entranced unless he

makes a save vs psionics. As long as the serpentoid maintains the gaze, the victim cannot move, run away, or attack. The mutant cannot attack, run or use any other powers, but he can approach the victim at a walking pace. The effect dissipates when the victim is struck, eye contact is broken (the victim cannot do this; only a third party can interfere), or the serpentoid stops using the power. Even after the entrancement is broken, the victim will lose initiative and one melee attack/action for one round.

3. Aura of Fear: This is a psionic enhancement of the natural feelings of fear and loathing inspired by snakes. The power costs 20 I.S.P. and affects a radius of 10 feet/3.0 m per level of experience. Anybody in the aura's radius will have to save against a Horror Factor of 14 (raise this by 1 at levels three, six, nine, and twelve, to a maximum H.F. of 18). The aura lasts for one minute per level of experience.

4. Psychic Venom: The serpentoid can bite victims with a venom roughly as powerful as a cobra's. Normal damage is 1D6 points of damage taken directly from hit points for 4D4 melees. The character must save versus lethal poison each melee; a successful save means no damage was taken on that round. Additionally, however, the serpentoid can "charge" his venom with psychic energy, inflicting incredible damage. One dose of venom can be charged at the cost of 15 I.S.P. If the venom is successfully injected, the victim must save vs psionics or take 2D6 to hit points or, for M.D.C. beings, 4D6 M.D. for 1D6 melee rounds! Saves must be made every round; a successful save reduces the damage to 1 point (S.D.C. or M.D.C.).

5. Other Psionic Powers: Considered to be a master psionic. In addition to the abilities listed above, the serpentoid has mind block auto-defense, hypnotic suggestion, and can choose a total of six powers from any of the healing, sensitive or physical categories.

6. I.S.P.: 2D6×10 plus M.E. number. Add 10 I.S.P. per level of experience.

Experience Level: Varies. Players characters start at the first or second level of experience. NPCs average 1D6+1.

Combat: As per skill.

Damage: Punches and kicks do damage as per supernatural P.S. when the force field is activated, and normal S.D.C. damage otherwise. Their bite does 2D4 S.D.C., or 2D6 M.D. when the force field is activated.

Bonuses: +2 save vs magic and psionics, +5 to save vs horror factor.

Magic Powers: None.

Psionic Powers: See above.

Vulnerabilities/Penalties: None.

R.C.C. Skills: These skills represent the basic military training all serpentoids undergo. Besides this training, the mutants can learn almost any other skills, representing their diverse professions and walks of life.

Language and Literacy: Spanish (98%)

One Language of Choice (+15%)

Basic Math (+15%)

Radio Basic (+15%)

Wilderness Survival (+10%)

W.P.: Energy Rifle

W.P.: Two of choice

Hand to Hand: Basic

Hand to Hand: Basic can be changed to hand to hand: expert at the cost of one "other" skill, or to martial arts or assassin (if evil) at the cost of two "other" skills.

R.C.C. Related Skills: Select eight other skills. Plus select two skills at level three, two at level seven, and one at levels ten and twelve. All new skills start at the base skill level.

Communications: Any (+5%)

Domestic: Any (+5%)

Electrical: Any

Espionage: Any

Mechanical: Any

Medical: Any (+5% on Paramedic or First Aid).

Military: Any

Physical: Any

Pilot: Any (+5%)

Pilot Related: Any (+5%)

Rogue: Any

Science: Any

Technical: Any (+10%)

W.P.: Any

Wilderness: Any (+5%)

Secondary Skills: The character also gets to select six secondary skills. These are additional areas of knowledge that do not get the advantage of the bonus listed in parentheses. All secondary skills start at the base skill level. Also, skills are limited (any, only, none) as previously indicated on the list.

Alliances and Allies: Other mutant animals will work side by side with the serpentoid. The mutant serpents' eeriness and emotional detachment often drives off many other mutant animals (especially rodents), to the point that most serpentoids have few friends outside their species (as in all stereotypes, there are many exceptions).

Weapons and Equipment: Equalizer combat shotgun or light striker laser rifle, energy sidearm of choice, 4 full reloads/E-clips for each. Customizable combat armor (M.D.C. 75), hand radio, gas mask, survival kit, bedroll, one week's rations, and survival knife.

Money: 3D6×100 credits.

Mutant Capybara R.C.C.

While searching for suitable species for mutations, the scientists of Project Achilles considered using a number of rodent varieties. Although rodents are not lethal predators, they have managed to survive in all kinds of environments, and are extremely hardy and persistent. The resulting mutation combined genes from rats, humans, and the largest rodents on Earth, the capybaras. Capybaras, a species native to South America, can weigh as much as 100+ pounds (45 kg.+), and their ancestors (now long extinct) actually approached 900 lbs. (405 kg), making them bigger than bears! The creatures are also extremely good swimmers, which made them useful for amphibious missions.

The mutant capybara combines the traits of the three genotypes very well, and is also a powerful psychic. The capybara's psychic abilities enable the mutant to survive underwater and resist extreme environmental conditions. But the mutant's most

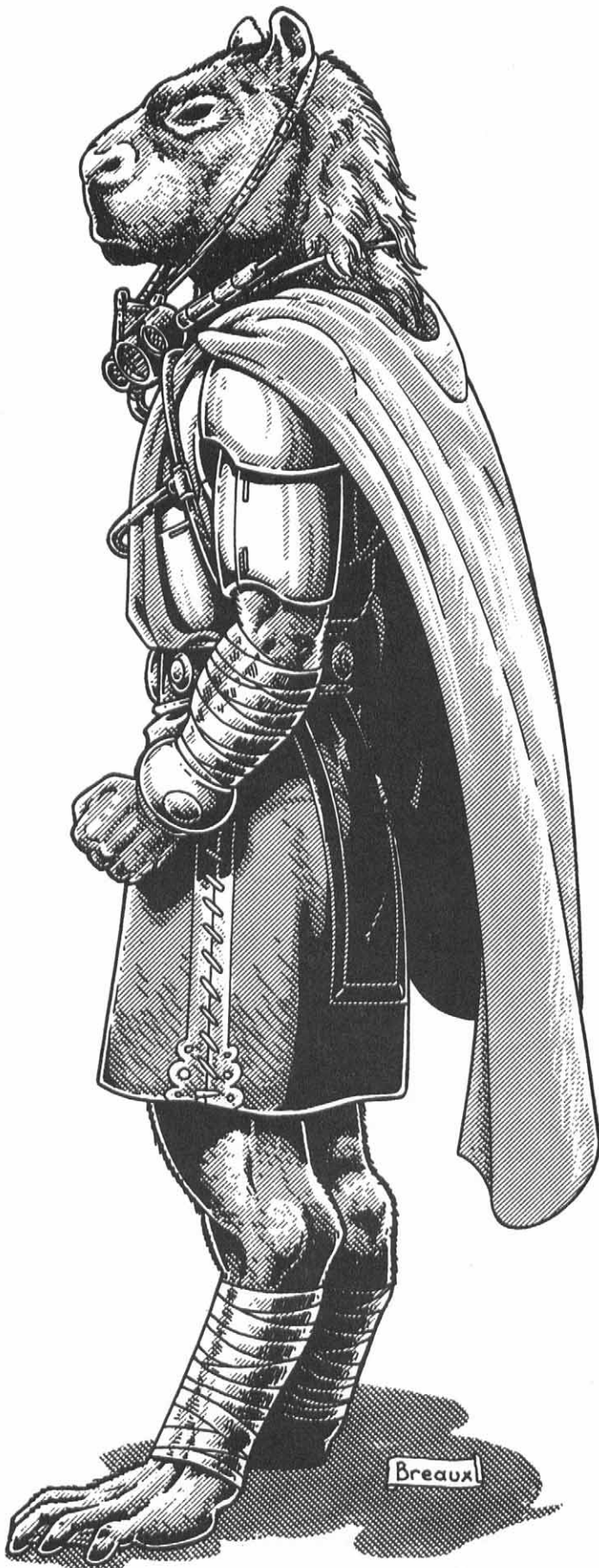

powerful abilities involve the psionic manipulation of dimensional energies. These powers are unique on Earth, although they may be related to the “phase powers” exhibited by the **Promethean** race (for more information about the Prometheans and their mysterious powers, refer to the *Phase World* dimension books). The capybara’s psychic feats include ley line transmission/teleportation, minor time warps, and the so-called “Psi-Wave,” a cone of energy that will knock down light robots and vehicles and will stun most creatures. At high levels, capybaras can travel between dimensions, and often leave Achilles for a few years while they explore the Megaverse. Groups of capybaras can even unleash ley line storms and close Rifts!

These abilities, which among other things, enable the mutants to see what normal living beings cannot perceive, gives them a mystical bent. They learn a great deal about the supernatural from their elders, and they often feel there is a greater purpose to everything that happens. The creatures also tend to be philosophical and laid back in their outlook. “What can’t be fixed today will be fixed tomorrow;” “Give time some time;” and “Don’t be in such a hurry to die,” are common capybara sayings. Many of these mutant rodents are elected to the Animal House due to their race’s reputation for wisdom and moderation. Capybaras who serve in the army often act as medics in addition to their military duties, especially if they have healing psychic powers.

Alignment: Any, but most (70%) are scrupulous.

M.D.C.: By armor or psionic power only.

S.D.C.: 2D6×10 plus skill and O.C.C. bonuses.

Hit Points: P.E.×2 plus 1D6 per level of experience.

Attributes: I.Q. 3D6+3, M.E. 3D6+8, M.A. 3D6+6, P.S. 3D6+4, P.P. 3D6, P.E. 2D6+8, P.B. 2D6, Spd. 3D6 running, or 1D4×10 swimming.

Size: 4 to 6 feet (1.2 to 1.8 m) tall.

Weight: 150-250 lbs. (68 to 113 kg.)

Horror Factor: 6

P.P.E.: 2D4

Average Life Span: 120 years.

Natural Abilities:

1. **Ley Line Transmission and Phasing:** By spending 2 I.S.P., capybaras can send verbal and/or visual messages along a ley line. This power is identical to the ley line walker’s, except that they expend I.S.P. instead of P.P.E. Also, the capybara can teleport across ley lines, at the cost of 6 I.S.P. This power has the same limitations as the ley line walker.

2. **Time Warp:** The capybara can speed up or slow down time around him by spending 25 I.S.P. The power can affect the character and/or one person per level of experience (maximum range is 60 feet/18.3 m plus 10 feet/3.0 m per level of experience). Unwilling subjects can resist (save vs psionics).

At first level, the character can speed up or slow down time by a factor of two. Speeding up time adds three actions/attacks per melee or doubles the number of attacks/actions the character has (whichever is LESS) and adds +3 to initiative and +3 to parry and dodge. Slowed up characters lose half their attacks/actions per round, and are at -4 to initiative and -2 to strike, parry and dodge.

3. **Psi-Wave:** This power costs 10 I.S.P. per attack. A cone of swirling psychic energy flashes forth from the character’s

head, striking targets both physically and psychically. The cone-shaped wave will affect a maximum area of 20 feet (6.1 m) plus 3 feet (0.9 m) per additional level of experience and is +2 to strike. Targets caught in the area of effect can dodge, but need to roll a 14 or higher. The wave inflicts 1D4 M.D., +1 M.D. per level of experience, and can knock down most beings or vehicles weighing less than 2 tons (4000 lbs./1800 kg)! Furthermore, living beings struck by the wave must save vs psionics or be stunned for 1D4 rounds (lose initiative and one melee attack, -1 to strike, parry and dodge, -10% on skill performance).

4. **Dimensional Powers:** The capybara mutants have a psychic connection with dimensional phenomena, a connection that eventually allows them to manipulate dimensional energies! At first level, capybaras can sense Rifts, ley lines and nexus points that occur within a mile (1.6 km) per level of experience. At third level, the characters can sense a Rift up to 50 miles (80 km) away. At fifth level, they can dimensionally Rift home as per the shifter power, at the cost of 150 I.S.P. At seventh level, the character gains the power to close Rifts, same as the spell but costs 200 I.S.P. plus 2 I.S.P. are lost permanently! At the same level, a group of at least four capybaras can unleash a ley line storm (see *Rifts® Underseas*, *Rifts® World Book Three: England* or *Rifts® World Book Two: Atlantis* for the effects of such a storm) by spending 150 I.S.P. each! Tenth level capybaras can dimensionally teleport at the cost of 75 I.S.P. plus 25 I.S.P. per additional person (89% accuracy for a dimension they have spent more than a month in, 76% for a dimension they have visited before, 65% for a dimension they have heard descriptions of but have never visited).

5. **Other Psionic Powers:** In addition to the special abilities described above, the capybaras get to select two powers from each of the healing, sensitive and physical categories. At each level after the first, the character gains one new power from any category, except super.

6. **I.S.P.:** Capybaras have 3D6×10 I.S.P. plus the M.E. attribute, plus they gain 10 I.S.P. per additional level.

Experience Level: Player characters start out at first or second level. NPCs range from 1st to 15th level! Average level is 1D6+1.

Combat: As per skill.

Damage: Bite does 2D4 S.D.C.; power punch (counts as two attacks) inflicts 1D4 M.D.

Bonuses: +1 to save vs magic, +4 to save vs horror factor.

Psionic Powers: See above.

Magic Powers: None.

Vulnerabilities/Penalties: None.

R.C.C. Skills:

Language and Literacy: Spanish (98%)

Languages: Two of choice (+15%)

Radio Basic (+10%)

Demon and Monster Lore (+15%)

Wilderness Survival (+5%)

Holistic Medicine (+10%)

W.P. Energy Rifle

W.P. one of choice

Hand to Hand: Basic

Hand to Hand: Basic can be changed to Hand to Hand: Expert at the cost of one "other" skill or to Martial Arts at the cost of two "other" skills.

R.C.C. Related Skills: Select six other skills. Plus select two more skills at level three, and one at levels five, eight, eleven and fourteen. All new skills start at first level proficiency.

Communications: Any (+5%)

Domestic: Any (+5%)

Electrical: Any

Espionage: Detect ambush and track humans only.

Mechanical: Any

Medical: Any (+10%)

Military: Any

Physical: Any except acrobatics.

Pilot: Any

Pilot Related: Any (+5%)

Rogue: Any

Science: Any (+10%)

Technical: Any (+10%)

W.P.: Any

Wilderness: Any

Secondary Skills: The character also gets to select four secondary skills. These are additional areas of knowledge that do not get the benefit of the bonuses listed in parentheses. All secondary skills start at the base skill level. Also, skills are limited (any, only, none) as previously indicated in the list.

Alliances and Allies: Other mutant animals. Also, as capybaras have often traveled through the Megaverse, their species is respected by Prometheans, temporal raiders, True Atlanteans and other dimensional travelers.

Weapons and Equipment: Equalizer combat shotgun or light striker laser rifle, energy sidearm of choice, 4 full reloads/E-clips for each. Customizable combat armor (M.D.C. 75), hand radio, gas mask, survival kit, bedroll, one week's rations, herbal medicine first-aid kit, and survival knife.

Money: 3D4×100 credits.

Equinoid R.C.C.

a.k.a. The "Psi-Taur"

The Psi-Taur was the result of forbidden experiments, forbidden even among the Achilles researchers. Unknown to most researchers, a renegade named *Leon Garcia* experimented with predominantly human genes. His goal was to recreate creatures of myth and legend. Dozens of unfortunate human "subjects" died in bizarre attempts to create mermaids, minotaurs and other monsters. Fortunately, Leon's secret experiments were discovered and stopped; Leon suffered an "accident" that took his life.

By that time, however, one viable strain had been developed. A humanoid, with the lower body of a horse. Unlike the mythological centaur, Leon's creation was covered with short fur, and the creature's hair was arranged in a crest, somewhat like a natural mohawk. The "equinoid" was as fast and strong as a normal horse, and had human intelligence. Even more impressive were its psionic powers. Unwilling to let such a promising subject go to waste, researchers continued the work, and soon an entire breed of "psi-taurs" was in the works. Like the myriad other mutants, the mutants escaped the Achilles' laboratories and helped found the non-human homeland.

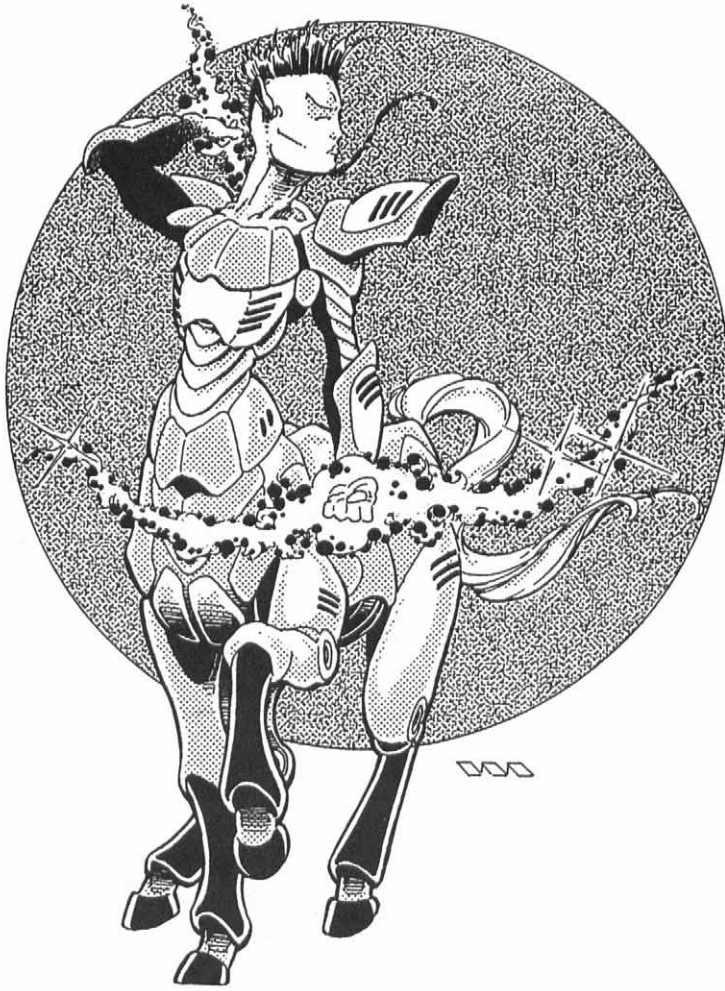

Psi-taurs have a number of superhuman powers. The most impressive one is the ability to telekinetically lift their bodies so they can “run” in empty air. The sight of a squad of these horsemen coming down from the sky has paralyzed foes with awe. Additionally, they have learned to fashion bows and arrows of pure psychic energy. The bow and arrow shape is entirely preferential (some psi-taurs prefer to simply fire their energy bolts from their hands) but most of them have adopted it in keeping with their mythological image. Also, they can surround themselves with psychic force fields. These force fields not only grant them protection, but they also allow them to inflict mega-damage with their bare hands.

The combat powers of this race make its members natural warriors, and every Psi-Taur undergoes extensive training. A full 70% of all young Psi-Taurs (ages 16-30) are full-time members of the Achilles Army, professional soldiers who make a career of army life. The rest are often scouts, messengers and bodyguards, sometimes competing with the **Blood Riders** and gauchos for the same jobs; there is a great deal of rivalry between these groups, most of it friendly.

Alignment: Any

M.D.C.: Telekinetic Force Field: 60 M.D.C. plus 10 M.D.C. per level.

S.D.C.: 1D4x100 plus skill bonuses.

Hit Points: P.E.x3 plus 2D6 per level of experience.

Attributes: I.Q. 3D6, M.E. 3D6+6, M.A. 3D6, P.S. 3D6+18, P.P. 3D6+6, P.E. 3D6+10, P.B. 4D6, Spd. 1D6x10+80 running/flying (90 to 140; roughly 60 to 100 mph/96 to 160 kmph)

Size: 8-9 feet (2.4 to 2.7 m) tall, about 5-6 feet at the shoulder (horse part).

Weight: 800-1200 lbs. (362 to 544 kg.)

Horror Factor: 8

P.P.E.: 2D6

Average Life Span: 120 years

Natural Abilities:

1. **Sky Running Telekinesis:** This power is similar to the Master Blood Rider’s levitation powers. At the cost of 10 I.S.P., the Psi-Taur can “run” in the air at the same speed he can on the ground. This power lasts 10 minutes per level of experience. Maximum altitude is 100 feet (30.5 m) above the ground per level of experience.

This ability also enables the mutant to leap 30 feet (9 m) from a standing still position or 60 feet (18.2 m) with a running start.

2. **Psi-Bow:** By spending 15 I.S.P., the character can create an energy “bow” that fires bolts of mental energy. Each bolt does 4D6 M.D. +1 M.D. per level of experience. The bolts are +2 to strike plus any bonuses from archery and targeting. Once activated, the bow lasts for one minute per level of experience. Firing range is 300 feet (91.5 m) +40 feet (12 m) per level of experience.

3. **Psionic Force Field:** This power costs 10 I.S.P. and lasts two minutes per level of experience. The force field protects the Psi-Taur with 60 M.D.C. plus 10 M.D.C. per level of experience. While the force field is on, the character can inflict mega-damage with his hand to hand attacks (see Damage, below).

4. **Other Psionic Powers:** The character can select six powers from the sensitive or physical categories. No new powers are gained at higher levels.

5. **I.S.P.:** 2D6x10+10 plus M.E. attribute. Add 2D6 I.S.P. per level of experience.

Experience Level: Player characters start at first or second level. Average NPC level of experience is 1D4+2.

Combat: As per skill, but add one melee attack per round.

Damage: When the force field is activated, punch does 1D4 M.D. plus P.S. bonus. (i.e., a Psi-Taur with P.S. 28 would do 1D4 +13 M.D.); foreleg kick does 2D4 plus P.S. bonus M.D., and hind legs kick does 3D6 plus P.S. bonus M.D. Without the force field, damage is the same, except it is reduced to S.D.C. damage. A power punch or kick does double damage but counts as two attacks.

Bonuses: +2 on initiative, +1 to strike and parry, +1 to roll with impact, +2 to pull punch, +1 save vs magic, +4 to save vs horror factor. All are in addition to attribute and skill bonuses.

Psionic Powers: See above.

Magic Powers: None.

Vulnerabilities/Penalties: The horse-sized Psi-Taurs cannot fit in small vehicles, nor can they use motorcycles, power armor or robots, nor can they pilot any vehicle not specially designed for their use. Prowl is at -10%.

R.C.C. Skills:

Language and Literacy: Spanish (98%)

Language: one of choice (+15%)

Radio Basic (+10%)

Tracking (animals and humans; +10%)

Wilderness Survival (+10%)

W.P. Archery and Targeting

W.P. One of choice

Hand to Hand: Expert

Hand to Hand: Expert can be changed to Martial Arts at the cost of one "other" skill.

R.C.C. Related Skills: Select eight other skills. Plus select two additional skills at levels three and six, and one at levels eight, ten and fourteen. All new skills start at the base skill level.

Communications: Any (+5%)

Domestic: Any (+5%)

Electrical: Any

Espionage: Any

Mechanical: Any

Medical: First aid and paramedic only.

Military: Any (+5%)

Physical: Any except acrobatics and climbing.

Pilot: Any except power armor and robots (Note: Can only be used for custom vehicles the Psi-Taur can use)

Pilot Related: Any

Rogue: Any

Science: Any

Technical: Any (+10%)

W.P.: Any

Wilderness: Any (+10%)

Secondary Skills: The character also gets to select three secondary skills at levels one and four. These are additional areas of knowledge that do not get the bonus listed in parentheses. Also, secondary skills are limited (any, only, none) as previously indicated on the list.

Alliances and Allies: Other mutant animals. Some Psi-Taurs and Blood Riders and many gauchos become friends despite their intense competition.

Weapons and Equipment: Custom Barding (90 M.D.C.), one energy weapon of choice plus four extra E-clips, hand radio, gas mask, survival kit, bedroll, one week's rations, and survival knife.

Money: 2D6×100 credits.

Condoroid R.C.C.

Some Project Achilles researchers worked on the creation of soldiers who could provide their own transport by flying. The most successful strains were the condoroid and falconoid. The first mutant race was based on the great condors of the South American mountains. These large scavengers were procured in great numbers under the guise of trying to "protect" the endangered species. The already scarce condors were almost com-

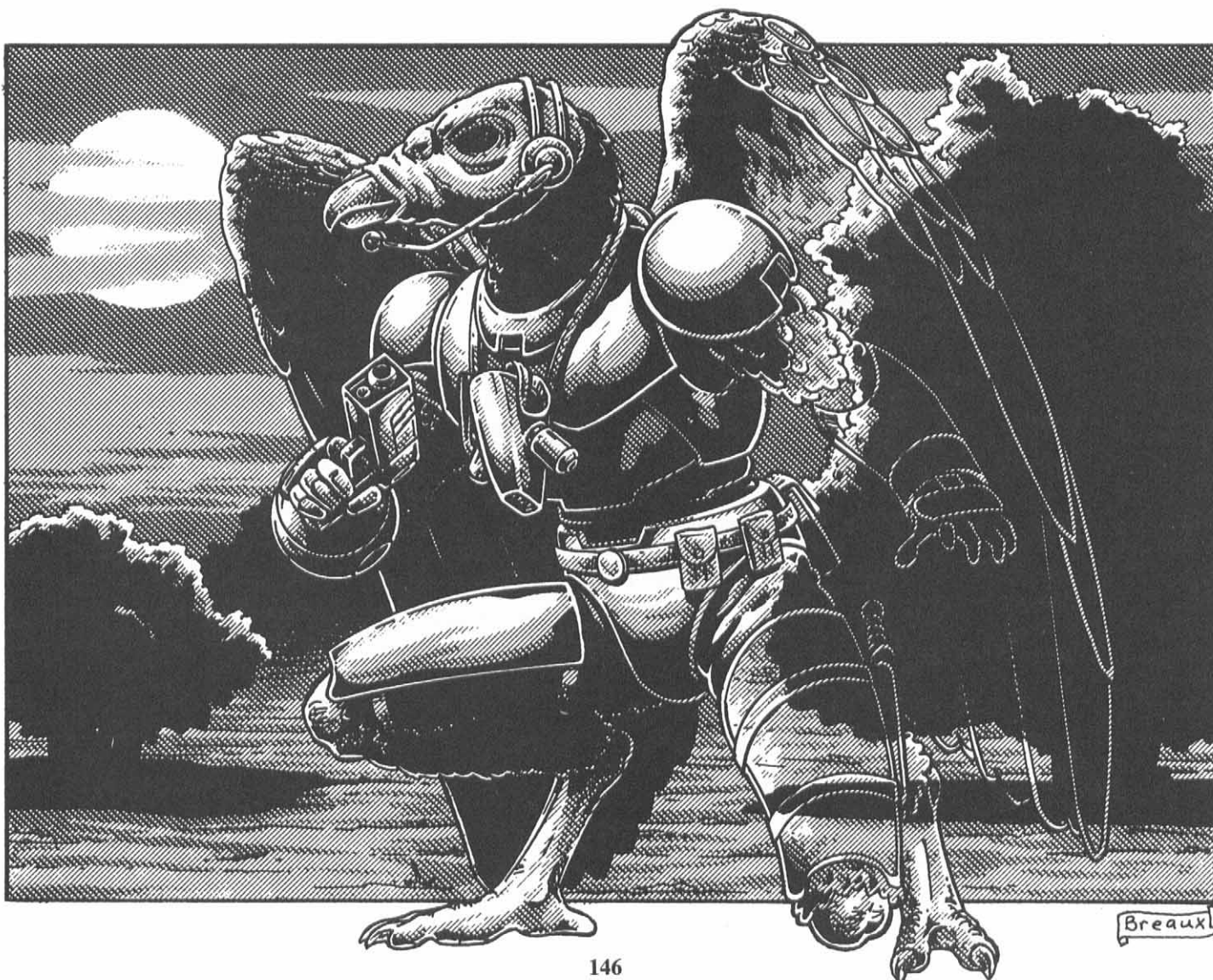

pletely exterminated by this research, since well over 90% of the animals taken to the labs died or were crippled by the genetic experiments. By the time of the Great Cataclysm, there were only a few hundred condors left in the wild.

The condoroid produced by these experiments was a human-sized "birdman" with wings on the back, independent humanoid arms, and two semi-humanoid legs. The head remained condor-like, and the creature's body was covered with feathers. To allow for human muscles, the condoroid became too heavy to fly by the use of wings; however, the mutant was still able to fly through psionic powers. After the Great Cataclysm, the psionic powers of the mutant became even greater.

A form of super-telekinesis allows the creature to fly at speeds approaching the speed of sound. By following the path of ley lines, condoroids can fly at speeds in excess of Mach 2 (1340 mph/2160 kmph)! The mutants also have a number of mental powers, including the ability of making themselves invisible through psychic illusions and the ability (very common among all mutant animals created by Project Achilles) to produce a psionic force field around their bodies.

Condoroids in the Achilles Republic often work as scouts and commando raiders, relying on their stealth powers to get past sensor systems and living guards. Many of these mutants also turn to a life of crime, forming small communities in the mountains and robbing unsuspecting victims. The bandits often limit their attacks to humans and D-Bees, respecting their fellow animal mutants and concentrating on Cordoba, Santiago, Arkhons and sometimes, the Inca Empire.

Alignment: Any, but 30% are anarchist and 20% unprincipled.

M.D.C.: Psionic Force Field: 30 M.D.C. plus 10 M.D.C. per additional level of experience.

S.D.C.: 2D4×10+20.

Hit Points: P.E. ×2 plus 2D4 per level of experience.

Attributes: I.Q. 3D6, M.E. 3D6+6, M.A. 3D4, P.S. 3D6+4, P.P. 2D6+10, P.E. 3D6+8, P.B. 2D4, Spd. 3D6 on the ground, up to 500 mph (800 kmph) flying under its normal abilities.

Size: 4-6 (1.2 to 1.8 m) feet tall; wingspan is typically three times the height of the character.

Weight: 100-200 lbs. (45 to 90 kg.)

Horror Factor: 8

P.P.E.: 2D6

Average Life Span: 100 years

Natural Abilities:

1. **Psionic Flight:** Condoroids can fly at great speeds. Their wings are useful for gliding, steering and maneuvering, but little else. Maximum speed is about 500 mph (800 kmph), except at ley lines. When flying on the path of a ley line (must be within 100 feet/30.5 m of the center of the ley line), condoroids can boost their speed to a maximum of Mach 2! The only problem is that at those speeds the mutant can only fly in a straight line and is unable to maneuver well. This speed boosts costs 2 I.S.P. per minute.

2. **Psionic Invisibility:** This power works on several levels. Matter and energy manipulation work to obstruct sensor systems and normal vision, while a telepathic impulse convinces people that the condoroid is not there. Sensor operator rolls are at -40% to detect the condoroid when this power is in effect, and living beings must make a save vs psionics to notice the mutant. Activating the power costs 15 I.S.P. and lasts one minute per level of experience.

3. **Psionic Force Field:** The condoroid can surround himself with a telekinetic force field that protects him with 30 M.D.C. at level one plus 10 M.D.C. per additional level of experience. Activating the force field costs 10 I.S.P. and the field lasts until its M.D.C. is depleted or for two minutes per level of experience.

4. **Other Psionic Powers:** Additionally, the condoroid get psi-sword, psi-shield, and can select six powers from the physical, sensitive and healing categories. At each new level of experience, the condoroid can select one additional power from any category, excluding super.

5. **I.S.P.:** Base I.S.P. is 2D4×10+10 plus M.E. attribute. Add 2D6 I.S.P. per level of experience.

Experience Level: Player characters start at first or second level of experience. NPCs average 1D4 +1.

Combat: As per skill.

Damage: Beak attack does 2D4 S.D.C.

Bonuses: +1 to strike and +2 to dodge while flying.

Magic Powers: None.

Psionic Powers: See above

Vulnerabilities/Penalties: None.

R.C.C. Skills:

Language and Literacy: Spanish (98%)

Language: One of choice (+15%)

Radio Basic (+10%)

Wilderness Survival (+10%)

Detect Ambush (+10%)

Track Humans and Animals (+10%)

W.P. Energy Rifle

W.P.: one of choice

Hand to Hand: Expert

Hand to Hand: Expert can be changed to hand to hand: martial arts or assassin at the cost of one "other" skill.

R.C.C. Related Skills: Select six other skills. Plus select two skills at level three and one skill at levels five, seven, ten and fourteen. All new skills start at level one proficiency.

Communications: Any (+5%)

Domestic: Any (+5%)

Electrical: Any

Espionage: Any (+5%)

Mechanical: Any

Medical: Any (+5% to Paramedic)

Military: Any

Physical: Any

Pilot: Any

Pilot Related: Any

Rogue: Any (+5%)

Science: Any

Technical: Any (+5%)

W.P.: Any

Wilderness: Any (+10%)

Secondary Skills: The character also gets to select five secondary skills. These are additional areas of knowledge that do not get the advantage of the bonus listed in parentheses. All secondary skills start at the base skill level. Also, skills are limited (any, only, none) as previously indicated in the list.

Alliances and Allies: Other mutant animals. Condoroids who become bandits often work side by side with Larhold barbarians, Arkhon renegades and human and D-Bee outlaws.

Weapons and Equipment: Equalizer combat shotgun or light striker laser rifle, energy sidearm of choice, 4 full reloads/E-clips for each. Customizable combat armor (M.D.C. 75), hand radio, gas mask, survival kit, bedroll, one week's rations, and survival knife.

Money: 2D6×100 credits.



Falconoid R.C.C.

While the condoroid mutant was a highly successful and promising creation, different teams of Achilles researchers tried to come up with a more impressive and deadly flying warrior. The team working on felines came up with the devastating Flying Tiger (see *South America: One*), while another team worked with the falcon. Hundreds of different varieties of these birds were imported and experimented upon. While dozens of lesser mutant species were produced, the researchers' main success was the falconoid. The genes that triggered such psionic powers as telekinetic flight and force fields were both present in this mutant. Furthermore, the creature could fire devastating bolts of mental energy that were capable of both destroying matter and shattering the minds of living things.

Falconoids are a vital part of the Achilles defense system. Since the republic does not have much in the way of an air force, these flying mutants are often the only thing standing between Achilles and enemy aircraft and flying power armor. Aerial duels between metal-clad warriors and lightly equipped mutants occur with distressing frequency over the plains. A few falconoids become expert pilots and fly the few aircraft the republic has with great skill and panache.

Alignment: Any

M.D.C.: Force Field: 80 M.D.C. plus 20 M.D.C. per additional level of experience.

S.D.C./Hit Points: 2D4×100 S.D.C. and P.E. ×2 Hit Points. Add 1D6 Hit Points per level of experience.

Attributes: I.Q. 4D6, M.E. 3D6+6, M.A. 4D6, P.S. 3D6+6, P.P. 4D6+6, P.E. 3D6+6, P.B. 3D6, Spd. 1D6×10 running, up to Mach 2 flying.

Size: 5 to 6 feet tall (1.5 to 1.8 m).

Weight: 90 to 120 lbs. (41 to 54 kg)

Horror Factor: 7

P.P.E.: 2D6

Average Life Span: 120 years.

Natural Abilities:

1. **Psionic Flight:** The falconoid can fly at speeds of up to Mach 2! While flying at these speeds, however, the character can only move in a straight line and is unable to maneuver. Cruising speed is typically Mach 1 (670 mph/1078 kmph) or less.

2. **Psionic Force Field:** The character can generate a force field to protect himself. This field lasts for two minutes per level of experience and costs 15 I.S.P. to activate. The field protects with 80 M.D.C. at level one plus 20 M.D.C. per additional level of experience.

3. **Psi-Blasts:** The falconoids can fire psionic bolts with both physical and psychic effects. These bolts originate from the heads or eyes of the mutants, and are +3 to strike. The bolts inflict 2D6 M.D. at level one, +1D6 M.D. at levels three, five, seven, nine, eleven and thirteen. Furthermore, any living being who is struck, even if armor absorbs the damage, must make a saving throw vs psionics or suffer 2D6 S.D.C. (M.D.C. if a supernatural being) and be stunned for 1D4 rounds (-1 on initiative, to strike, parry and dodge, and -10% on skill performance). Each Psi-Blast costs 6 I.S.P. to shoot and has a range of 2000 feet (610 m).

4. **Other Psionic Powers:** In addition to the powers listed above, falconoids get to select six powers from either the physical or sensitive categories.

5. **I.S.P.:** Falconoids have 2D6×10 I.S.P. plus the M.E. attribute. Add 8 I.S.P. per additional level of experience.

Level of Experience: Player characters start at first or second level of experience. NPCs average 1D4+1.

Combat: As per skill.

Damage: Beak inflicts 1D6 S.D.C.

Bonuses: +1 on initiative, +1 to strike and dodge in the air, +3 to roll with punch, fall or impact, +2 to pull punch.

Magic Powers: None.

Psionic Powers: See above.

Vulnerabilities/Penalties: None.

R.C.C. Skills:

Language and Literacy: Spanish (98%)

Language: One of choice (+15%)

Radio Basic (+10%)

Wilderness Survival (+10%)

Track Humans and Animals (+10%)

W.P. Energy Rifle

W.P.: two of choice

Hand to Hand: Expert

Hand to Hand: Expert can be changed to Hand to Hand: Martial Arts or Assassin at the cost of one "other" skill.

R.C.C. Related Skills: Select six other skills. Plus select one skill at levels three, five, seven, ten and fourteen. All new skills start at level one proficiency.

Communications: Any (+5%)

Domestic: Any (+5%)

Electrical: Any

Espionage: Any

Mechanical: Any

Medical: Any (+5% to Paramedic)

Military: Any

Physical: Any

Pilot: Any (+10%)

Pilot Related: Any

Rogue: Any (+5%)

Science: Any

Technical: Any (+5%)

W.P.: Any

Wilderness: Any (+10%)

Secondary Skills: The character also gets to select five secondary skills. These are additional areas of knowledge that do not get the advantage of the bonus listed in parentheses. All secondary skills start at the base skill level. Also, skills are limited (any, only, none) as previously indicated in the list.

Alliances and Allies: Other mutant animals.

Weapons and Equipment: Equalizer combat shotgun or light striker laser rifle, energy sidearm of choice, 4 full reloads/E-clips for each. Customizable combat armor (M.D.C. 75), hand radio, gas mask, survival kit, bedroll, one week's rations, and survival knife.

Money: 2D6×100 credits.



Achilles

Neo-Human R.C.C.

The last years of Project Achilles were plagued with secret and internal conspiracies. Competing teams trying to outdo the other project members started conducting experiments hidden from each other. Thus, felinoid mutants (fully described in *Rifts South America: One*) were created in only one research center without the knowledge of the other centers. When reports of their success (once they succeeded, they wasted no time sharing the news) reached the other centers, the pressure to do better increased. A team of scientists decided that mutating animals was not the way to go. Instead, they decided to directly improve the human body!

Human embryos were experimented upon, mutated and altered. Genetic material from several members of the research center, stolen from them without their consent, was used to fast-clone the embryos and manipulate their genetic make-up. The goal was to copy the genes that seemed to be linked to psionic powers. All these activities were the work of a small faction

within the center, done without the knowledge of the rest. Cordelia Valdez was a researcher there, and she accidentally discovered the experiment. Her shock was compounded by the realization that most of the embryos carried her genetic code, making them, in effect, her offspring. Her desire to preserve these "children" led her to stage the break-out that saved the founders of the Achilles Republic.

The offspring of Cordelia Valdez looked completely human. Their bodies had near god-like physical perfection, and they were extremely intelligent and perceptive. Beyond these outward appearances was a fountain of psychic power, perhaps the most powerful psionic species ever created. Each of the neo-humans had enough psychic abilities to fight a tank bare-handed, heal the sick, and destroy people with but a thought. They combined the strength of a supernatural being with the abilities of a mind-melter. In the decades following the Coming of the Rifts, however, two groups of neo-humans chose different directions. The first one, nicknamed the "Neo-Abels," stayed with their "mother's people," the mutant animals. The other group, the "Neo-Cains," abandoned their companions, motivated by a sense of superiority and contempt for all the "lesser" races.

The neo-humans were incredibly long-lived; those who haven't died by violence have lived for nearly 300 years so far, and they have shown little sign of aging. The amount of I.S.P. energy they manage to store seems to have an effect on the aging process; the more I.S.P. the neo-human can store, the more slowly he will age. As a result, even good neo-humans are very concerned with using their abilities under challenging conditions and thus grow more experienced and powerful.

In Achilles, neo-humans are viewed with ambivalent feelings. On the one hand, their value to the Republic is unquestioned; on more than one occasion, these psychics have saved the entire nation from supernatural entities, Cordoban conspiracies and Arkhon raids. On the other hand, their human appearance and haughty attitude leads to hatred and distrust. The fact that the most powerful of the mutants look human is a bitter pill for the animal mutants to swallow. Although the neo-humans are closer genetically to the mutant animals than to "real" humans, their looks and raw power are enough to inspire negative feelings. Suspicion, bickering and competition often mars the relations between neo-humans and their mutant brethren. As a result, a few neo-humans have left Achilles and now wander the Megaverse, working with such beings as demigods, dragons, cosmoknights, True Atlanteans and their like.

The number of neo-humans is very low (accounting for less than 1% of all mutant animals). The "Neo-Abels" work within the Republic, acting as secret agents, special forces soldiers and other champions. Nobody knows what happened to the Neo-Cains. Some rumors claim these beings evolved even greater powers, and they have left Earth for other worlds. Others blame the "Cain-brood" for everything that goes wrong in the Republic, from crime to natural disasters, and often the finger is pointed to any neo-human who happens to be nearby. Some rumors claim that a band of supposed Neo-Abels have created a society of "Young Gods."

Alignment: Any.

M.D.C.: See psionic powers.

S.D.C./Hit Points: 4D6×10 S.D.C. and P.E.×3 hit points. Add 2D6 hit points per level of experience.

Attributes: I.Q. 3D6+8, M.E. 2D6+14, M.A. 4D6, P.S. 3D6+12, P.P. 3D6+6, P.E. 3D6+10, P.B. 2D6+12, Spd. 5D6

Size: Slightly taller than humans; average height is 6 feet, six inches (1.95 m).

Weight: Average 200 lbs (90 kg) of muscle.

Horror Factor: 9 when their identity and powers are revealed.

P.P.E.: 2D6; most P.P.E. is spent to develop psychic powers.

Average Life Span: Varies. The neo-human's life span seems to be tied to their base I.S.P. The formula seems to be 100 plus I.S.P. ×3 years. As neo-humans grow in power, their psychic energies appear to slow down the aging process.

Natural Abilities:

1. Supernatural Transformation: The neo-human can transform himself into a supernatural being. While transformed, the neo-human's strength becomes supernatural, and his S.D.C. and hit points become M.D.C. points! The transformation temporarily halves the neo-human's I.S.P. base. Any I.S.P. points over half are "spent" and cannot be regained until the transformation is over. Furthermore, every hour after the transformation, 2 I.S.P. are subtracted from the character's I.S.P. base, and cannot be regained until the transformation is over. When the I.S.P. base is utterly depleted, the transformation ends.

Example: Mentallia, a 6th level neo-human, has 312 I.S.P. She spends 37 I.S.P. on diverse powers during the course of a fight with an Arkhon cyborg (275 points remain), before she decides to undergo the transformation. This reduces her I.S.P. base from 312 to 156 (of the 275 points she had, 119 are "lost"). She spends an additional 60 points in the fight (leaving her with 96 I.S.P.) and after defeating the Arkhon cyborg, she remains super-charged for two more hours. During that time, her I.S.P. capacity is lowered by an additional 4 I.S.P., to 152; this does not affect her current I.S.P. (remains at 96), but even if she meditates, she can't regain more than 152 I.S.P. until the transformation power runs its full duration.

2. Hyper-Telekinesis: This power costs 50 I.S.P. to activate. The neo-human can move massive amounts of weight, the equivalent of M.E. ×100 pounds (45 kg), +100 pounds (45 kg) per level! So, a 3rd level psychic with M.E. 20 could lift 2,000 pounds (one ton!). M.D.C. objects thrown with this power will inflict 1D4 M.D. per 200 lbs. (90 kg) of weight or fraction thereof. In the example above, the psychic could do 1D4×10 M.D. if he could find an M.D.C. object weighing a ton. Range is 100 feet (30.5 m) plus 50 feet (15.2 m) per level of experience. Bonuses and effects are otherwise identical to normal telekinetic powers.

3. Telekinetic Flight: The same power that allows the psychic to lift and throw huge weights also allows him to fly at great speeds. This power costs 15 I.S.P. and lasts 2 minutes per level of experience. The psychic can fly at a maximum speed of 100 mph (160 kmph).

4. Mind-Wave: The neo-human can attempt to disorient an opponent's mind by sending it on a "trip." Victims of this attack get to save vs psionics at -2 to save (so even a master psionic must roll a 12 or higher to save). A successful save means the character is suddenly overwhelmed by a splitting headache and is -2 on initiative and -10% on skill performance for 2D4 minutes.

A failed roll sends the character's mind on an uncontrollable mind trip, as if riding a gentle wave on the ocean or

among the clouds in the sky. The victim feels warm, at peace and awestruck. He or she loses all sense of time, his mission, goal, danger, and everything around him. While in this euphoric state, the character slumps to his knees and does absolutely nothing for 2D4 melee rounds +1 per level of the neo-human. Nothing can rouse the character from the mind wave except being struck with serious physical damage! The shock and pain brings the character around but all his attacks per melee, bonuses, speed and skill performance are half for 2D4 minutes! If allowed to snap out of the trance at the end of its natural duration, the character suffers no ill effects whatsoever.

Only one person can be affected by a mind wave per psionic attack, and each attack counts as the equivalent of two melee attacks. This power costs 30 I.S.P. to activate, and has a maximum range of 300 feet (91.4 m).

5. Touch of Health or Death: This psionic ability requires that the psychic touches the subject (body armor will not stop the touch, but power armor or the armor of a vehicle will). Activating either power costs 15 I.S.P.

If healing is chosen, the subject regains 1D6×10 S.D.C. or M.D.C. points, and any non-magical diseases, infection and fractures (but not missing limbs) are cured. If the subject was in a coma, he gets a +30% bonus to survive! The Touch of Death literally saps the life force of the victim; if a save vs psionics is not made, the victim takes 1D4×10 S.D.C. or M.D.C. damage, and must make a save vs lethal poison or fall unconscious for 1D4 melee rounds! If the save vs psionics is made, the character takes 1D6 S.D.C. (or 2D6 M.D.) but suffers no other ill-effects.

6. Other Psionic Powers: In addition to the special powers listed above, the character gets to select three powers from each of the four categories (including super), with the same restrictions as a mind melter. An additional four powers, one from each category, can be selected at level two, three more from any category at level three, and two more per each subsequent level of experience.

7. I.S.P.: 1D4×100 plus M.E. attribute number. Add 12 I.S.P. per level of experience.

Experience Level: Varies. Player characters should start at first level. NPCs average 1D4+1.

Combat: As per skill.

Damage: Varies (see Natural Abilities, above).

Bonuses: +1 on initiative, +1 save vs magic, +3 to save vs possession and mind control, +6 to save vs horror factor.

Magic Powers: None. Neo-humans spend their P.P.E. in the mastery of psionic powers.

Psionic Powers: See above.

Vulnerabilities/Penalties: None.

R.C.C. Skills:

Language and Literacy: Spanish (98%)

Language: One of choice (+15%)

Radio Basic (+10%)

Intelligence (+10%)

Disguise (+10%)

W.P. Energy Rifle

W.P.: two of choice

Hand to Hand: Expert

Hand to Hand: Expert can be changed to Hand to Hand: Martial Arts or Assassin at the cost of one "other" skill.

R.C.C. Related Skills: Select five other skills. Plus select one skill at levels three, five, seven, ten and fourteen. All new skills start at level one proficiency.

Communications: Any (+5%)

Domestic: Any (+5%)

Electrical: Any

Espionage: Any (+10%)

Mechanical: Any

Medical: Any (+5%)

Military: Any

Physical: Any

Pilot: Any (+10%)

Pilot Related: Any

Rogue: Any (+5%)

Science: Any

Technical: Any (+5%)

W.P.: Any

Wilderness: Any (+5%)

Secondary Skills: The character also gets to select two secondary skills at levels one, five and ten. These are additional areas of knowledge that do not get the advantage of the bonus listed in parentheses. All secondary skills start at the base skill level. Also, skills are limited (any, only, none) as previously indicated in the list.

Alliances and Allies: Other mutant animals, but the neo-humans get along best with the mutant capybaras, and the worst with serpentoids. Some neo-humans also become friends with mind melters, master blood riders and other powerful psionic beings. Others enjoy the company of godlings, demigods, True Atlanteans, dragons and other powerful beings.

Weapons and Equipment: Energy rifle of choice, energy side-arm of choice, four full E-clips for each. Choice of human-type body armor, usually light and unrestrictive types are favored (M.D.C. 45 to 60), hand radio, gas mask, survival kit, bedroll, one week's rations, and survival knife.

Money: 2D6×100 credits.



New Babylon

Population Breakdown: 5.3 million total; humans make up 35%, Amaki Stone-Men 45% and other D-Bees, mutants and other races make up the remaining 20%.

New Babylon is the wealthiest and perhaps the most hated and distrusted member of the Silver River Republics. The nation is one of the few successful partnerships between humans and alien beings. The D-Bees in question are the Amaki, emigrants from a prosperous but over-populated world who have chosen to make their homes on Earth. Under this alliance, huge towers taller than pre-Rifts skyscrapers have been built in the middle of burgeoning cities, which now dot the lower regions of the continent. The influence of New Babylon reaches as far South as **Terra del Fuego, the land of fire**, and merchant ships brave the Amazon River, the Devil's Triangles and the oceans. This has enabled the New Babylonians to sell their wares as far as England and Africa and even parts of North America.

Technology and techno-wizardry, especially psionic-based techno-wizardry, flourish in this land. The New Babylonians' genius for all forms of science and engineering have become nearly legendary in the region. At the same time, however, the nation has a terrible reputation everywhere else. The Babylonians, both human and Amaki, are considered to be corrupt and decadent. This reputation comes from their flaunting of wealth, both in their country and when traveling elsewhere. Babylonians, as a culture, love to enjoy life to the fullest, both by getting the best comforts money can buy, and by cavorting in such activities as partying, gambling and amorous escapades.

To the more stoic and strict nations in the area, the Babylonians seem to favor excess. Males are believed to be gluttons, luses and lechers. Their love for poetry, artistic endeavors, and strange clothing (from capes, cloaks and boots to embroidered coats and even powdered wigs) has given them a reputation for being effeminate and cowardly. Women are considered to be "loose," ready to cavort with anybody, any time. Many refer to *Babylon Major*, the capital city, as "the City of Sin."

Despite their reputation, very few people want to mess with the Babylonians. Almost all members of the middle and upper classes are superb swordsmen, and the combination vibroblade/pistols they favor as their personal sidearms are not just for decoration. Also, the "effeminate" Babylonians have fought and won every conflict with their neighbors. A powdered wig may elicit laughter from outsiders, but there is nothing lacking in their courage, or bloodthirstiness if provoked to violence.

For all their qualities, the citizens of New Babylon have an attitude of superiority and almost, total contempt of all other peoples, which is partially responsible for their bad reputation (envy and fear of the strange and unusual account for the rest). This has made for strained relations with their neighbors since the republic was formed a century and a half ago.

History

The Amaki civilization developed on an Earth-like world millennia ago, and it is still going strong. The planet was unified by

a confederation of Noble Guild Houses, merchants, craftsmen and professionals who had transcended loyalties to nations and regions, and instead were loyal to their fellow House members. House Rule allowed the Amaki to advance in leaps and bounds, soon learning the rudiments of space travel (although they have yet to develop a faster-than-light drive) and, more importantly, the secrets of transdimensional travel. The Amaki developed a unique blend of psionics, techno-wizardry and science, an "art" they called *Gizmoteering*. Gizmoteers could make anything out of raw materials, and with time, effort and imagination, they could mix psionics and technology in a manner similar to the techno-wizards. Using psionic techno-wizardry, the Amaki tinkers and gizmoteers were able to pierce the barriers separating dimensions and started traveling to new, alien worlds. Earth was one of those worlds.

Amaki explorers arrived in the lower part of the South American continent about one hundred years after the Great Cataclysm. They were disappointed to find that the planet had suffered a terrible holocaust, that most human cities had been utterly destroyed, and the survivors lived in small villages or traveled as nomadic tribes. They were, however, delighted to realize that the land was rich with both magical energies and mineral resources. The Amaki, in their typical "enlightened self-interest" saw an opportunity to help the human survivors while building a prosperous colony.

In a few decades, over 100,000 colonists arrived on Earth. The newcomers had to deal with human fear and hatred, D-Bee raiders, monsters, and many other dangers. No less than three colonies were completely wiped out, but the rest persevered, built up and conquered the challenging, savage land. Many of the smaller Amaki gatherings started hiring humans as assistants and apprentices. Eventually, those humans, or their descendants, became full-fledged members of the Noble Guild Houses. These humans started calling the Amaki "Babylonians," a term that was first used by a rogue scholar who compared the stone-like beards of the Amaki with pictures of Babylonian and Assyrian nobles and warriors. The name stuck (the rogue scholar eventually became Guild Master of the House of Learning), and the first large city the colonists built was named New Babylon, which would eventually become the name of the entire colony.

Amaki and human culture mixed in ways that puzzled and entertained the Amaki back home; to this day, the New Babylon House of Music produces bizarre mixtures of Argentinean and Amaki styles so popular that their recordings are sold everywhere the Amaki go, including Phase World, Worldgate, and other transdimensional trade centers. Humans have also excelled in the fields of techno-wizardry, psionics and engineering. While the Amaki have often partnered with other races, the success of the human-Amaki alliance is unprecedented. There is even a growing human minority (totaling some 250,000) on the Amaki homeworld, 80% migrants from Rifts Earth.

Problems arose in the early post-apocalyptic (P.A.) years. The growing nation of Cordoba started a genocidal war against the mutant nation of Achilles (see the **Achilles Republic section**). As the Cordoban armies pushed South, they started threatening Babylonian cities. When diplomatic negotiations failed to turn back the human armies, the Babylonian House of War mobilized, supported by the other House militias. A masterful series of pincer attacks quickly cut off and destroyed the Cordoban spearhead in less than seven days.

As a result of this humiliating defeat, which incidentally saved the Achilles Republic from destruction, the Cordoba government formally declared war on New Babylon. A second conflict, this one lasting over a year, followed. The Cordoba armies were limited by the fact that they had to travel through territories under the influence of other nations, including the hostile Achilles Republic, so they were never able to mass with any efficiency. By the thirteenth month of the conflict, it became clear that Cordoba had lost the war. The Babylonian armies, reinforced by troops from the Amaki homeworld, were preparing to launch a counterattack into Cordoba's territories, and the Borges government did not want to bring devastation to their own lands, so a peace treaty was finally drafted and put into effect. The two countries are not and will never be friendly towards each other, but a tenuous peace exists.

Other lesser conflicts have flared up and down throughout the history of the nation, with New Babylon winning every one. The burgeoning nation has grown in size and influence, to the point that today it is the second largest Silver River Republic.

Government and Society

The New Babylon government is commonly known as the "House Rule." The Noble Guild Houses of New Babylon form the basis of the government, and are also the basic glue that holds society together. Originating in the trade and craft guilds of the Amaki's past, the Noble Guild Houses are associations in which every particular trade or profession is practiced.

Among the main Houses are the **House of Arms**, which manufactures weapons and armor; the **House of Sailors**, who own and sail most of the ships and transports of New Babylon (including its Navy); the **House of Engineers**, involved in all construction projects; the **House of Magic**, which controls all forms of magic and psionics (originally considered to be another form of magic); the **House of Health**, which includes all doctors and medical researchers, and the **House of Money**, which deals with banking, the treasury, and currency. Each house has smaller, more specialized Chapters. For example, the House of Sailors has a Chapter of War (the Navy), a Chapter of Commerce (dealing with merchant ships, as well as tariffs and duties at seaports), and a Chapter of Design, in charge of research and development of new and better vessels. The Chapters of different Houses typically work together; the House of Sailors' Chapter of Design, for example, works with several Chapters of the House of Engineers.

A person's position in society is determined by his or her standing within a House and a Chapter. The basic ranks (in ascending order) include Apprentice, Probationer, House Member, Chapter Member, Chapter Master, and House Master, the highest level within a house. Dozens of sub-ranks exist within those five, and they vary from House to House. To go up in rank, candidates compete fiercely against each other, striving to outdo the rest. In theory, cheating, backstabbing and similar "cutthroat" competition is not condoned, but in some Houses, people can get away with murder if they do it carefully enough.

About 70% of the adult citizens of New Babylon are Apprentices and Probationers (roughly 35% of each). Their status is that of laborers and semi-skilled workers who do most of the physical, tedious and menial work in the nation, from secretaries and data entry operators to janitors. They make decent salaries, and

their standard of living is one of the highest on Earth; only the NGR can compete in terms of quality of life. A lot of their money goes into luxuries, the latest fashions, and other frivolous expenses; "New Babylonians work hard and play harder" is a common saying throughout the SRR.

House Members are the equivalent of the lesser nobility and knights. They have valuable skills and are usually young go-getters on their way up (or old-timers who were left behind and are now on their way down). They enjoy a number of luxuries and privileges, and are notorious party-goers and slaves to fashion. Chapter Members are specialists who are good enough to work full-time for a single Chapter in their House; their salaries, privileges and authority are correspondingly greater. Chapter Members have the most sub-ranks, from recently promoted House Members to advisors and assistants to the Masters, with powers equivalent to a prime minister. The Masters of a Chapter answer only to the overall House Master. House Masters answer to the House Master of the Amaki homeworld (which is rarely required), and to the Masters' Council. The Masters' Council is the ruling body of New Babylon; all the Chapter and House Masters attend it, and the group elects a President who acts more as a moderator of discussions than as a real executive.

Each House has its own militia, which can be called up to serve in case of emergency. Some Houses' militias are better trained and equipped than others; the House of Sailors' militia is much better than, for example, the House of Painters'. Additionally, there is a standing army, the House of War, which is unique among all the other Houses in that it has no Master. Instead, it is ruled by the Masters' Council. Another special group is the House of the Sword, a small guild which serves as a fencing school (swordsmanship is greatly admired in New Babylon, practiced by almost 60% of its population), and, it is rumored, as an assassin's guild. The dreaded Duelists are all members of the House of the Sword; they are master psionics in addition to being superb swordsmen. Some believe Duelists often perform other, less savory tasks, including espionage and assassination.

Although this arrangement might seem chaotic to outsiders, the Amaki and human Babylonians have managed to make it work for centuries. Amaki culture values protecting one's House and society at large over personal success, so most members will never betray or harm the greater whole for their own benefit. Merit is considered to be the most important quality in any person. Wealth is assumed to be merit's just reward, as is enjoying one's life in any way possible.

New Babylon is by no means a perfect society. Almost 20% of the overall population is not affiliated with the Noble Guild Houses. These "house-less" people have very little recourse against connected persons. While in theory, the laws are applied equally for all, House members (even Apprentices) have the support of their entire House. Mess with one of them, and you are messing with the entire House, whether the situation is a bar fight, a lawsuit, or a criminal case. The person's fellow House members will assist the person in need, so long as he isn't harming the interests of the House. That means non-associated persons will lose most confrontations with House members.

Also, inter-House conflicts can be very nasty. Many Houses are very jealous and protective of their interests, and sometimes resent another House getting involved, cheating or stealing something from them. These conflicts can even lead to violence,

although for the most part, the Masters' Council will deal with such conflicts before they get out of hand.

Foreign Affairs

The Achilles Republic: Although the Babylonians and the Achilles Republic share a common enemy in Cordoba, diplomatic contact between the two nations is minimal. A treaty of non-aggression has been signed between the two nations, with a proviso that either country can hire mercenaries from the other nation should Cordoba launch an attack, but no formal alliance has been established. The main stumbling block is that the Achilles mutants think the Babylonians are too decadent to make good allies. Commerce between the two nations is widespread, because psi-based TW weapons and equipment manufactured in New Babylon are very popular among the mutant animals.

The Empire of the Sun: There is a Babylonian Embassy in Cuzco, and vice versa. Relations between the two unusual nations are rather cordial, and Babylonian ships can find safe harbors anywhere on the Inca coastline. The gods of the Pantheon of the Sun respect the Amaki and their culture, and the humans and Amaki from New Babylon are intrigued by the Inca Empire and its glories. Inca-like fashion is popular in New Babylon, and there is a brisk trade of clothing, art and luxury articles between the two countries. However, it is unlikely that New Babylon would come to the assistance of the Empire unless the threat also endangered the Babylonians' interests.

The Cordoba Republic: Despite the peace treaty signed decades ago, there is no love lost between the two countries. As far as the Cordobans are concerned, New Babylon is the beachhead of an alien invasion — lecherous, dissolute aliens at that. New Babylon has a number of spies (many of them Duelists disguised as merchants) in Cordoba, alert for any signs of war or invasion. The spies have discovered signs of an imminent war between Cordoba and Santiago, and the Masters' Council is discussing whether or not to intervene.

The Santiago Republic: Besides commerce (Santiago is a big customer of New Babylon and produces some advanced technology that is of interest to the Amaki), there is little formal contact between Santiago and New Babylon. The human nation is moderately friendly toward the Amaki and their human partners, and New Babylonians are never bothered by the authorities, although the occasional jeering or malicious private citizen may cause brawls, incidents and worse. Should Cordoba attack Santiago and appear to be winning, New Babylon *might* attack to prevent Cordoba from gobbling up the other large human nation to prevent that racist, genocidal republic from getting any stronger.

The Arkhon Freehold: The Arkhons and the Babylonians have very little contact. Occasionally, an Arkhon raid will reach into Babylonian territory, resulting in bloody skirmishes, but for the most part the two powers leave each other alone. The Amaki are concerned about this aggressive alien presence on the planet, so if the Arkhons start expanding, the Babylonians will oppose them with all their might.

The Megaversal Legion: The Babylonians know of the Legion through the Amaki. By a twist of fate, the Amaki hired the Legion some thirty years back, during a confrontation with a marauding horde of dimensional raiders. The Legion actually didn't acquit itself very well in the battle, and the Amaki became

contemptuous of the slave soldiers. Babylonian spies discovered that the Legion has recently freed itself from its Dakir masters, and the Amaki members of the country are considering establishing diplomatic and commercial relations with that regional power. Some Amaki enjoy visiting Peace City, where the Legionnaires spend much of their free time.

The Larhold Barbarians: New Babylon is the closest nation to the roaming grounds of these barbarians. Raids and full-scale attacks are frequent, but they rarely do much damage before they are repulsed.

Colombia, Maga Island and the Kingdom of Bahia: There is only commercial contact with those nations. The House of Energy has recently acquired a contract with Colombia (see *Rifts South America: One*) for a nuclear powered factory. This contract may lead to the Colombians getting the tools to manufacture nuclear power sources for their vehicles and weapons, which would greatly strengthen that nation. Colombia's enemies, including the Vampire Kingdom of Haktla and the Kingdom of Lagarto, do not want that to happen, and will do their best to sabotage the deal.

Maga Island and Bahia also purchase a number of staples from New Babylon, but they know little of the countries to the South.

The Kingdom of Lagarto: Babylonian merchants have brought back dire news of a rising lizard man kingdom, ruled by dragons and with links to the dreaded Splugorth. Although the Amaki have not had any direct contact with the Splugorth, they have heard enough about their cruelty and brutality to want nothing to do with those alien intelligences and their pawns. While once there had been some trade between the lizard man kingdoms and Babylonian ships, the Masters' Council has declared a boycott against Lagarto, and their ships avoid the entire area. Recently, a few merchant vessels have been lost while traveling off the coast of Lagarto and up the Greater Amazon river. The Babylonian Navy is considering sending warships up the Atlantic coast to protect their shipping lanes.

Psyscape: Some rumors speak of a powerful community of psychics in North America. This community, known by such names as "Psi-world" and "Psyscape," is rumored to be a place where psionic abilities have been developed to their utmost. A group of psionically-adept travelers, including a Neo-Human from Achilles, a mystic, a duelist, a mind melter and three gizmoteers, left looking for Psyscape a few years ago. Using an experimental telepathic transmitter, they reported they had seen something in the Ohio valley area, and then their reports stopped. The House of the Mind (which specializes in psionic abilities) is considering sending a larger team to North America to investigate (**Note:** This psychic community in North America will be fully described in a *Rifts World Book*, spring or summer 1996).

Amaki Stone-Man R.C.C.

The Amaki are humanoids with rock-hard skin. Their bodies appear to be made of sculpted marble, and their size and proportions are very similar to those of humans; the shape of most Amaki follows the human ideal of perfection. Most male Amaki have protrusions under their chins that are shaped to resemble

the ornate beards of Assyrian or Babylonian sculptures. They have no other hair or hair-like growths, their skin is smooth and cool to the touch. Although their flesh has some of the elasticity of humans, it is surprisingly tough and strong; Amaki are impervious to small arms and can even survive minor M.D.C. damage! Although their natural color is a shiny gray or black, Amaki, both male and female, like to paint themselves in diverse colors, from human like pink and brown tones to outlandish red, blue and green shades. Their clothing styles are incredibly varied and extravagant, running the whole gamut from skin-tight jumpsuits (some of them inspired by Arkhon fashions!) to stylized, multi-layered dresses adorned by lace, embroideries and ruffles.

Despite all these similarities to human shape, the Amaki had no contact with humans until their arrival on Rifts Earth. They found humans to be the most "Amaki-like" race they've ever encountered, which may account for the strong bonds of friendship they've established with their human partners. Marriages between humans and Amaki are not infrequent; although such unions cannot produce children, couples traditionally adopt a child from each race.

Alignment: Any, but lean towards good and selfish.

M.D.C.: None; but can survive minor M.D.C. damage.

A.R.: Skin has a natural Armor Rating (A.R.) of 16.

S.D.C.: 3D6×100 S.D.C. (the equivalent of 3-18 M.D.C.)

Hit Points: P.E. ×10 plus 4D6 per level of experience. This means that the Amaki can survive minor M.D. attacks (1 M.D.C. equals 100 S.D.C.).

Attributes: I.Q. 3D6, M.E. 3D6+2, M.A. 3D6+2, P.S. 2D6+12, P.P. 3D4+10, P.E. 3D6+6, P.B. 3D6+2, Spd. 3D6

Size: 5 to 7 feet tall (1.5 to 2.1 m).

Weight: 120 to 200 lb. (54 to 90 kg)

Horror Factor: 6

P.P.E.: 4D6

Average Life Span: 300 years

Natural Abilities: Nightvision 1000 feet (305 m), exceptionally good hearing and vision (slightly above the best human levels), rapid healing (heal damage five times as fast as humans!).

Special: Damage Resistance: Amaki are naturally resistant to most forms of damage; all non-magical attacks, including physical and energy attacks, do only *half* damage. Magical and psionic attacks do normal damage.

Experience Level: Variable. Typical NPC is 1D4+1.

Combat: By skill.

Damage: Restrained punch does 1D4 S.D.C. plus P.S. bonus, full strength punch does 4D6 S.D.C. plus P.S. bonus, power punch does 1D6 M.D. (counts as two attacks).

Bonuses: +1 on initiative, +1 to parry and dodge, +2 to roll with impact, +2 to save vs horror factor.

Magic Powers: A number of Amaki have magical abilities (see Common O.C.C.s, below).

Psionic Powers: Amaki have a higher incidence of psionics than humans. 01-20% Major Psionics, 21-50% Minor Psionics, 51-64% Master Psionics and 65-00% No Psionics.

Vulnerabilities/Penalties: None.

R.C.C. Skills: The following skills are known by almost all (95%) adult Amaki on Rifts Earth: Amaki (98%) and Spanish (+20%). Almost all (95%) adult Amaki have W.P. sword and

W.P. energy pistol (the two skills necessary to use the Amaki blast sword). Additionally, most are great dancers: dancing skill (+15%) and select one musical instrument or singing (+10%). These are in addition to O.C.C. skills.

Common O.C.C.s: Besides the Duelist and Gizmoteer O.C.C.s (see below), common adventurer O.C.C.s include headhunters, wilderness scouts, rogue scholars, operators and city rats.

Military O.C.C.s: Identical to the CS O.C.C.s, as well as the *occasional* master assassin, bounty hunter, special forces, smuggler, thief and spy (see *Rifts Mercenaries*).

Magical O.C.C.s: Most Amaki magicians are techno-wizards (50%); other common magical O.C.C.s include shifters (10%), ley line walkers (10%), temporal mages (see *Rifts World Book Three: England*; 10%), and others (20%; includes warlocks, mystics, shamans, etc.).

Psionic O.C.C.s: Many Amaki are master psionics. Mind melters are the most common (50%), although duelists, bursters and the *equivalent* to psi-stalkers and mind-bleeders also exist.

Alliances and Allies: New Babylon is a result of the Amaki's respect, like and friendship with humans. On other worlds, the Amaki have made contact with True Atlanteans, and have made alliances with a number of their clans. Amaki adventurers and champions often travel with True Atlanteans.

Weapons and Equipment: Varies with O.C.C.

Duelist R.C.C.

All Amaki know something of the ways of the sword. Since ancient times, when disputes between clans were sometimes resolved by duels at dawn, Amaki sword fighting was refined as an art, and for some, a way of life. Amaki Duelists are master psionics who have channeled their powers into the way of the sword. While their psychic expertise in other areas is stunted, they are possibly the deadliest swordsmen in the Megaverse.

Duelists are raised in the House of the Sword, a House that, among other things, provides the fencing teachers for the rest of the Amaki people. Duelists are taught to focus their psionic energy first in the ability to wield any blade with total mastery, and then to use the same psionic energy to produce a sword of pure psychic energy. Only a few other psychic powers are developed to protect the character's body and his mind from intrusion.

There is a great deal of speculation that the House of the Sword also sells its services to other houses and even the government, as assassins, spies and secret agents. Duelists know these rumors to be true, because they are trained from childhood, when their psionic powers first develop, to be more than just master swordsmen but multi-skilled soldiers and secret agents. Duelists often use their fame as a cover for their other activities. During espionage missions, they rarely use their psionic blades, and instead use common blast swords (the energy blades used by most Amaki adults) and other weapons. While duelists are master swordsmen, they do not abandon the study of all other weapons. In fact, duelists are expected to be competent in at least four different weapons at the end of their training period and before the initiation ceremony where three older Duelists help the youngster call forth his psi-blade. After this ceremony, the Duelist is given a techno-wizard psi-blade that enhances the strength of his psi-sword (see the *Weapons and Equipment* section).



These warriors are perhaps the most serious and humorless members of the Amaki race or the New Babylon enclave. Their training takes up so much of the Duelists' childhood that they rarely get the chance to have fun or enjoy life. After their initiation, the Duelists loosen up a little bit, but they generally lack the love for a good time that most members of their culture share.

Duelists often travel alone or in small groups. In Amaki cities, they openly show themselves for what they are. Outside New Babylon, they often hide their TW blades and rely on normal weapons. These travelers are usually undertaking missions for their House or their House's current employers. Missions range from simple exploration expeditions, especially to areas of Rifts Earth that have no contact with New Babylon, to spy and sabotage missions against the Arkhons or Cordoba.

R.C.C. Abilities and Bonuses:

1. Psi-Sword: Upon passing the initiation ceremony, the Duelist is taught to summon/create a psi-sword. This psychic weapon is closer to the mind melter's blade than to the cyber-knight's. Unlike the cyber-knight's psi-sword, the Duelist's psi-sword costs 15 I.S.P. to activate (lasts 5 minutes per level of experience). The weapon is typically shaped like a rapier or saber. Whatever its shape, it inflicts 4D6 M.D. at level one, and does an additional 1D6 M.D. at levels three, five, seven, nine, twelve and fifteen. This damage can be enhanced by the use of a *techno-wizard psi-blade* (typically 6D6 M.D. at first level).

2. Psi-Field: A psionic force field can be created around the character. The field is skin-tight and invisible, although psychics and magicians can detect it with the right spells or powers (sense magic, see aura, etc.). It protects the character with an M.D.C.

equal to his M.E. attribute $\times 2$ (i.e., a character with M.E. 16 would be protected by a field with 32 M.D.C.); this is raised by 3D6 M.D.C. per level of experience. Each activation of the force field costs 15 I.S.P. and lasts 2 minutes per level of experience.

3. Other Psionic Powers: The Duelist gets the following psionic abilities: bio-regeneration, psi-shield, mind block, nightvision, empathy, and presence sense.

No other psionic powers are ever gained by the character; his psychic abilities having been focused on creating his powerful psi-sword, psi-field and enhanced fighting abilities. Despite the few but formidable powers, Duelists are considered to be master psionics.

4. I.S.P.: 2D6 \times 10 plus M.E. attribute. Add 2D6 I.S.P. per additional level of experience.

5. Psi-Swordsmanship Combat Bonuses & Abilities: Bonuses and abilities are the result of both physical and mental training to hone their "union" with the sword.

Paired weapons, but can only create one psi-sword, the other must be man-made (vibro-blade, techno-sword, rune weapon, etc.).

+2 to disarm. The disarm attack is designed to make an opponent drop his weapon. This is typically done by striking, knocking or snaring and flinging an opponent's weapon away. The *player* must announce his character's attempt to disarm and rolls to strike as usual. His opponent can parry or dodge by rolling a 20 sided die. The high roll wins; ties go to the defender. If the defender successfully parries or dodges, the *disarm* attack fails and does no damage. If the *disarm* attack is successful, no damage is inflicted but the defender drops his weapon (it skitters or bounces 1D4 yards/meters away). He will have to grab a new weapon to defend himself or to continue his attack (losing initiative and one melee action/attack), or surrender. If facing an opponent with paired weapons, only one weapon can be disarmed at a time, and the paired weapons defender is +2 to parry the disarming attack!

When using a sword, the character is actually more confident and is +2 attacks per melee round, +6 on initiative, +2 to strike, parry and dodge, +4 to pull punch/sword strike, +2 to roll with punch, fall or impact, +2 to save vs magic or poison, +2 to save vs psionics, and +6 to save vs horror factor — but reduce these bonuses by half when not armed with a sword. These bonuses are in addition to attribute and skill bonuses (cumulative).

In addition, the character is equally skilled and confident with swords of all kind, large or small, man-made or magical.

6. Physical Bonuses: +2 to P.E., +1D6 to Spd., +1D4 \times 10 to S.D.C. and fatigues at half the usual rate.

Duelist R.C.C.

Alignment: Any

Attribute Requirements: Master psionics, M.E. 14. P.P. 13 and P.E. 14. Also see physical bonuses, below.

Note: In the Amaki's history, only Amaki and trusted humans loyal to the House of the Sword, have been trained as Duelists. Theoretically, it is possible for other psi-oriented races to learn these skills, if they could find a teacher, but so far, this psionic discipline has been reserved for members of the House of the Sword.

O.C.C. Skills:

Language and Literacy: Amaki (98%)
Language and Literacy: One of choice (98%); typically Spanish or New Babylonian.
Basic Radio (+10%)
Prowl (+10%)
Detect Ambush (+10%)
Climbing (+10%)
W.P. Sword (paired)
W.P. Energy Pistol
W.P. One of Choice
Hand to Hand: Martial Arts

O.C.C. Related Skills: Select seven other skills and one additional W.P.. Plus select two skills at level four, and one at levels six, eight, ten and thirteen. All new skills start at the base skill level.

Communications: Any
Domestic: Any
Electrical: Basic only.
Espionage: Any (+5%)
Mechanical: Automotive only.
Medical: First aid or paramedic only (+5% on First aid)
Military: Any (+5%)
Physical: Any (+10%) if applicable
Pilot: Any (+5%)
Pilot Related: Any
Rogue: Any (+5%)
Science: Any
Technical: Any (+10%)
W.P.: Any
Wilderness: Any

Secondary Skills: The character also gets to select three secondary skills at levels one, five and ten. These are additional areas of knowledge that do not get the benefit of the bonus listed in parentheses. All secondary skills start at the base skill level. Also, skills are limited (any, only, none) as previously indicated on the list.

Standard Equipment: Duelist body armor, TW psi-blade, Amaki blast sword and one energy weapon of choice; 4 E-Clips for each; a set of travel clothes, a set of good clothing, boots, gloves and cape.

Money: 2D6×1000 in credit.

Cybernetics: None; rarely get any.

There are gizmoteers in every Amaki House. They work as designers, researchers and troubleshooters. The troubleshooters are expected to deal with almost every imaginable problem, from helping with security to acting as investigators, secret agents and bodyguards. In fact, gizmoteers sometimes assist Amaki Duelists in their missions. Some who learn the psionic powers of psi-swords even pass themselves off as duelists! This, of course, is not taken lightly by the real Duelists, and has caused problems between the two groups. Unlike duelists, gizmoteers are light-hearted and easy-going, much more like the average Amaki than the dour sword-masters.

Since the establishment of New Babylon, dozens of gizmoteers have struck out to explore Rifts Earth. Many of them have not been heard of since; whether some tragedy befallen them, or they are still traveling remains unknown.

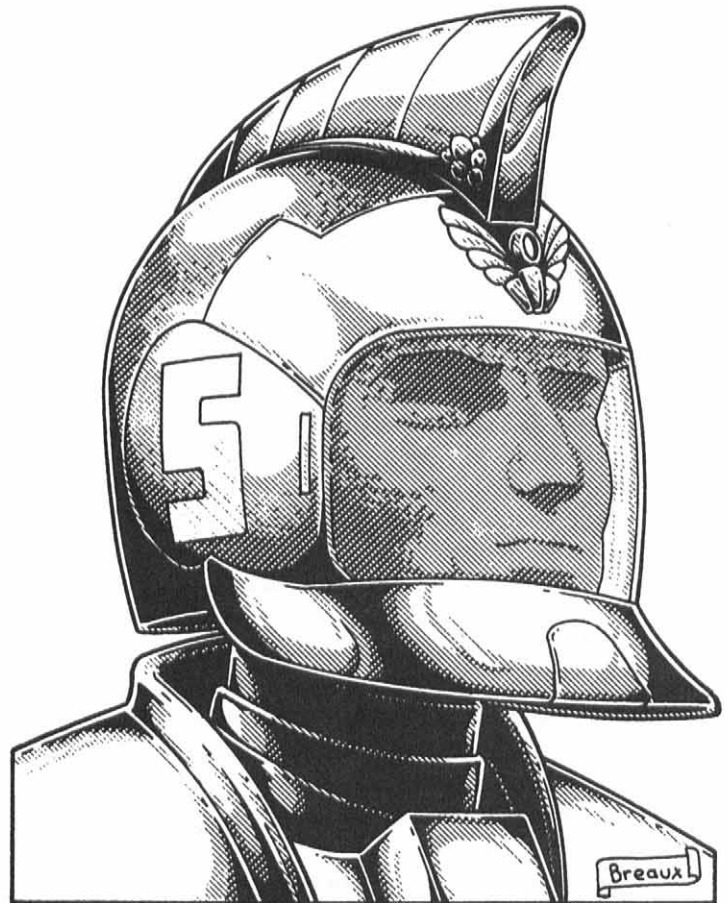

Gizmoteer R.C.C.

The Amaki Gizmoteers are a special brand of psychic, similar to the techno-wizard, but who can modify and even create devices on the spot. Although their best devices are those developed over time, a gizmoteer can modify any device he wants, albeit temporarily. Such devices as the "techno-wizard" psi-blades were at least partially designed by gizmoteers. Gizmoteers and techno-wizards often work side by side creating unusual devices or are off adventuring. Their outlooks are very similar, and although gizmoteers do not use magic, they understand the principles behind techno-wizardry and can use any TW item.

R.C.C. Abilities and Bonuses:

1. Modify Machines: Gizmoteers have the ability to enhance and modify machines. This is a psionic power related to telemechanics, and costs 15 I.S.P. to use. The gizmoteer can increase the damage, range or payload of a weapon, the speed and maneuverability of a vehicle, the range of a sensor or communication system, and any other element of the machine that the GM finds appropriate. The modifications are only temporary, and it has a good chance of damaging or destroying the enhanced machine as it "burns out," performing beyond its normal capabilities. The modification process takes 1D4 minutes, during which the Gizmoteer disassembles and reassembles the machine or some of its components. Tools are helpful, but even without them, the character can psionically open and take apart most machines. Among the things that can be modified are:

- **Damage:** +1 die per every two levels of experience; i.e.: a 1st or 2nd level character can increase the damage by +1 die, a 3rd or 4th level character +2 dice of damage, and so on. Thus, a third or fourth level gizmoteer could modify a laser that normally does 2D4 M.D. to inflict 4D4 M.D.
- **Range:** +5% to the maximum range per level of the character. This includes the range of sensor systems, rifles, pistols, missiles, etc. The maximum range of a vehicle that uses fuel or electric cells can also be increased.
- **Payload:** The energy content of an E-clip, battery or similar energy container (but not a magazine of bullets) can be increased by 10% per level of experience of the gizmoteer.
- **Vehicle Speed:** The maximum speed of a vehicle can be increased by 10% per level of the character.
- **Maneuver Bonuses:** The Gizmoteer can make a vehicle more responsive to the pilot. For every level of experience, the vehicle will gain a +3% skill bonus for anybody with the skill to pilot it.

Duration of Improvements: The modifications are temporary and will only last one hour per level of the character's experience.

- **Penalties:** There are some serious consequences to souping-up weapons and machines beyond their normal level of tolerance. There is a 10% chance per level of the gizmoteer's experience that the machine will completely burn out at the end of the duration period! That means at tenth level and above, the machine will always be destroyed after being modified — burned out by the tremendous stress and super-performance these high level gizmoteers can place on the device (maxed out). However, the psychic can choose to limit the level of power to below his maximum ability. For example, a seventh level psychic can choose to modify a gun to only do +1 die of damage (first level), which only has a 10% chance of destroying the gun, or +2 dice (3rd level), which has a 30% chance of destroying it, but the improvement will still last seven hours, the full duration of his power level.

2. Create techno-wizard Devices: These abilities are similar to the techno-wizard's but rely on psychic powers alone. A techno-wizard, mage, any psychic and anyone who can use TW devices can use the devices. Instead of I.S.P., magicians use P.P.E., but the cost is doubled! Some of the possible creations include:

- **Convert an energy weapon to psionic energy:** Cost: 60. Psi-Powers Needed: Mind bolt. Result: Any gun that can be powered by an E-clip can be converted to use psychic energy. I.S.P. Cost to Recharge: Equal to the number of shots the gun normally has for an E-clip. For example, a C-18 laser pistol has 10 shots from a normal E-clip, so recharging the gun would cost 10 I.S.P. (or 20 P.P.E.).
- **Psychically-reinforced Armor:** Cost: 200 I.S.P. Psi-Powers Needed: Telekinetic force field. Result: The armor is surrounded by a field of psychic energy that protects it with 10 M.D.C. per level of the gizmoteer who created it. Cost to Activate: 20 I.S.P. (or 40 P.P.E.).
- **TK-Machinegun, TK-Engine Conversion and Mystic Generator, equal to the techno-wizard devices, but uses I.S.P. as the main source of power** (i.e., the psionic TK-Engine costs 260 I.S.P. instead of 260 P.P.E.). Psi-Powers Needed: Telekinesis (super), electrokinesis and mind bolt.

Cost to Activate: Use the P.P.E. costs of the spells used for those engines, but replace it with I.S.P.; double that amount of P.P.E. can be substituted.

- **Psionic Device:** The gizmoteer can build a "gizmo" that can produce any psionic power that he knows! Creating the gizmo costs ten times as much as the basic cost of the psionic power. Activating the psionic powers costs as much I.S.P. (or twice as much P.P.E.) as the regular power. For example: a gizmoteer who knows the power, sense evil (2 I.S.P.) can make a "sensor helmet" with that power at the cost of 20 I.S.P. Anybody who can use TW devices can wear the helmet and activate it by spending 2 I.S.P. (or 4 P.P.E.).

Materials Cost: 100 credits for every I.S.P. point of the power's activation cost. These materials are typically a plastic casing and circuitry that is rearranged and charged with I.S.P. In the example above, the "sensor helmet" would cost 200 credits to build. Note: This is the cost in a civilized area where circuitry and other high-tech components are readily available; cost can be doubled or tripled in remote areas. The sale cost is usually 10-50 times the construction cost. Time to Create: Typically, one hour of work for every I.S.P. point it costs to create the gizmo (in the example above, the "sensor helmet" would take 20 hours to build).

3. Psionic Powers: The Gizmoteer can select psionic powers, but he can only use most of them in devices/gizmos. Only a few powers can be used on their own.

The character starts with the following powers (these powers can be used without creating a gizmo): mind block, speed reading, total recall, electrokinesis, and telemechanics.

In addition to these powers, the character has an understanding of psychic powers that he can build into machines: select two powers from all four categories, with the same limitations as a mind melter. Every level after the first, select an additional two powers from any categories, again with the same limitations as a mind melter. All of these powers can NOT be used without first building a gizmo (but see starting gizmos).

4. Starting Gizmos: The character starts out play with 1D4+2 gizmos of any powers he knows. Additional gizmos must be built or purchased.

5. I.S.P.: 2D4×10 plus M.E. attribute number. Add 2D6 I.S.P. per additional level of experience.

Gizmoteer R.C.C.

Attribute Requirements: M.E. 12 or higher.

O.C.C. Skills:

Language and Literacy: Amaki (98%)

Language and Literacy: One of choice (+20%; in New Babylon, this is usually Spanish)

Radio: Basic (+15%)

Advanced Math (+15%)

Basic Electronics (+15%)

Pilot: One of Choice (+10%)

W.P. Energy Pistol

W.P. Sword

Hand to Hand: Basic

Hand to Hand: Basic can be converted to Hand to Hand: Expert at the cost of one "other" skill, or to Martial Arts at the cost of two "other" skills.

O.C.C. Related Skills: Select 10 other skills, but at least four must be selected from the electrical or mechanical categories.

Plus select two additional skills at level three, two at level six, and one at levels eight, ten and twelve. All new skills start at level one proficiency.

Communications: Any (+10%)

Domestic: Any

Electrical: Any (+15%)

Espionage: Intelligence and wilderness survival only (+5%)

Mechanical: Any (+15%)

Medical: Any (+5%)

Military: Any (+5%)

Physical: Any

Pilot: Any (+5%)

Pilot Related: Any (+5%)

Rogue: Any

Science: Any (+10%)

Technical: Any (+10%)

W.P.: Any

Wilderness: Any

Secondary Skills: The character also gets to select five secondary skills. These are additional areas of knowledge that do not get the benefit of the bonus listed in parentheses. All secondary skills start at the base skill level. Also, skills are limited (any, only, none) as previously indicated in the list.

Standard Equipment: Suit of body armor (can even select Duelist body armor), blast sword and 4 spare E-Clips, one energy or non-energy weapon of choice, basic tool kit, miniature tool kit (can be carried in a pocket but is less effective), canteen, sleeping bag, two sets of dress clothing and one set of traveling clothing. In addition, he gets a few gizmos (see #4, above).

Money: 2D4×1000 in credits.

Cybernetics: None to start, and will usually refuse to get any.

Other Republics

Besides the nations described above, dozens of other minor republics and kingdoms exist among the Silver River Republics. The following list describes some of the most notable ones.

The Southern Federation

Population Breakdown: 1.1 million total (70% humans, 30% D-Bees).

"*Le Federacion del Sur*" is a loose confederation of cities and towns located in the southeastern tip of the continent. This area was one of the least populated and prosperous places on the continent, but the Great Cataclysm changed all that. During the great upheavals of the Coming of the Rifts, three entire cities were Rifted into the area! This phenomenon may have been caused by the proximity of the South American Devil's triangle (see below). It appears that entire continental segments were interchanged with similar areas in other worlds. The three cities came from different worlds and different times. All but one were made up of humans or D-Bees so close to human to allow interbreeding. One was a medieval-like, fortified town controlled by super-powerful High Wizards. The power of these wizards is incredible; even beginners are a match for hatchling dragons and lesser supernatural beings.

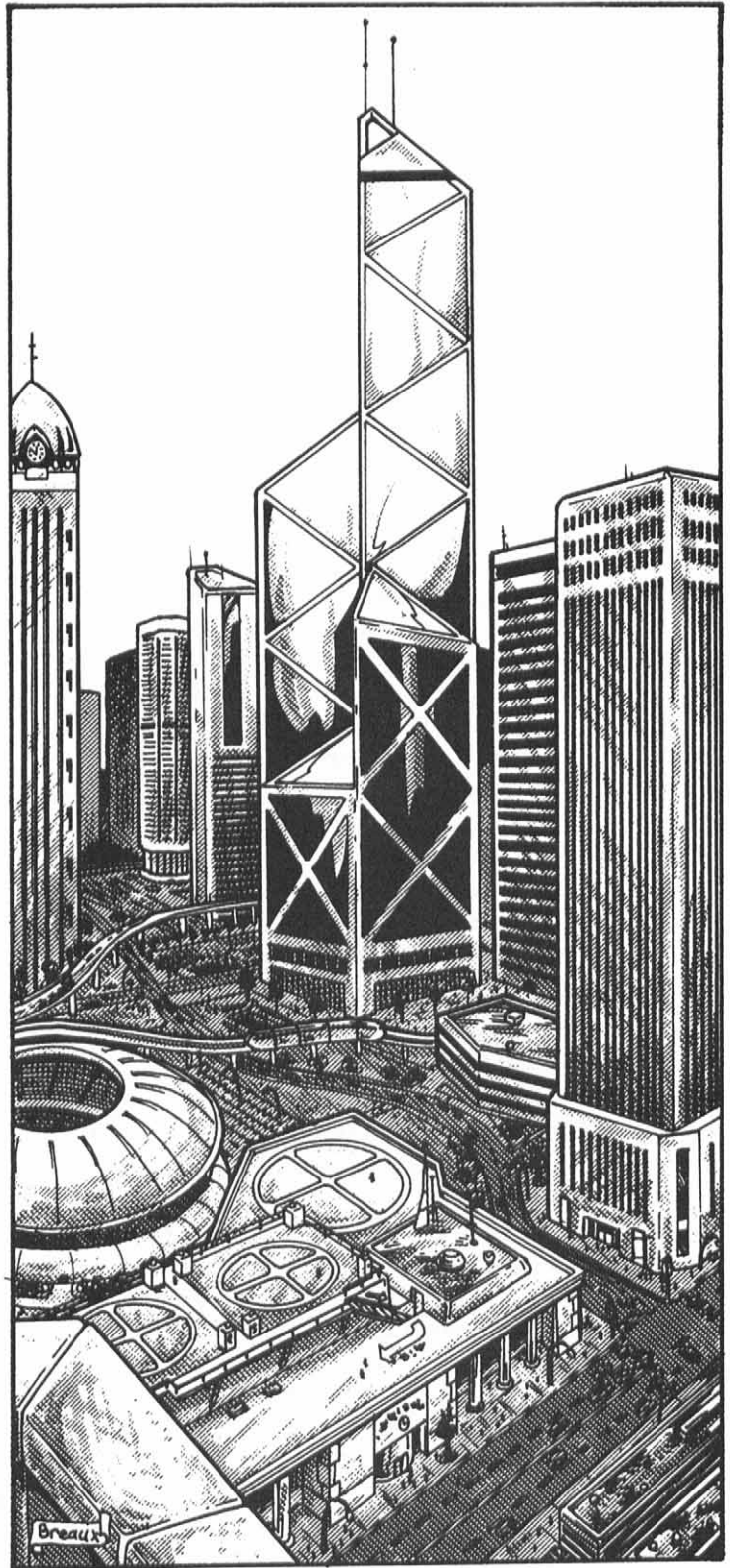

The second human city was highly technological; according to the Rifted survivors, their city was the Experimental Arcology of Patagonia, built in the year 2095; and Rifted in on December 22, 2098 — the same year the Rifts occurred! No pre-rifts record show the existence of such a city, and the Arcology's citizens have a higher level of technology than known pre-Rifts Earth levels, so the city was probably Rifted in from a parallel Earth, one where history took a different turn.

The inhabitants of the third city were human-looking, but came from the strange world of **Wormwood** (see *Rifts Dimension Book: One*).

The three cities appeared fairly close to one another, each within 100 miles (160 km) — and each appearing at a ley line nexus. Although the arrival destroyed buildings and killed nearly 60% of the entire population of each city, the survivors managed to pull together and make it through the strange days that followed. Smaller D-Bee communities also arrived to the area; some made their own towns and cities, while others became citizens of the three cities. The cities eventually decided to ally themselves to face the Larhold threat (described elsewhere). Only the alliance survived; all the smaller cities and towns that did not join the Federation have been destroyed by the Larhold and other ravagers, or survive as client nations of the Larhold.

The Federation prospered and has successfully held the Larhold at bay (the so-called barbarians now content themselves with ranging west of the three cities). Enormous deposits of valuable minerals, including petroleum, iron, gold, uranium and platinum, have been discovered around the cities. It is unknown whether these deposits were Rifted in at the same time as the cities, or they were deep underground until the Great Cataclysm moved them closer to the surface. This mineral wealth has allowed the Federation to rebuild their cities and keep a brisk trade of raw minerals going with Santiago, Cordoba, Achilles and New Babylon. Such resources is helping the Federation to become a major center of technology and commerce.

Note: O.C.C.s and R.C.C.s found in the Federation includes equivalents of those found in the **Rifts® RPG** (excluding cyberknights, Glitter Boys, bursters, dog boys and dragons; cyborgs and cyberoids like those described in *Rifts® Japan* are probably more appropriate for the high-tech city of the alternate Earth), **Rifts® Mercenaries** (excluding the Naruni) and **Wormwood™** (excluding the Host and their evil minions).

The Shining Path

Population Breakdown: 25,000 total, of which about 10,000 are fighting men and women; the rest are villagers forced to assist the guerrillas. 80% of them are human, the rest are humanoid D-Bees.

Before the Coming of the Rifts, Peru, Bolivia, Ecuador and Argentina had been suffering from guerrilla raids at the hands of Communist revolutionaries. Nicknamed “the Shining Path,” these guerrillas started operating in late 20th Century Peru, and continued their attacks, on and off, for the next century. In the years before the Great Cataclysm, the guerrillas had expanded their operations to several other nations, and were growing in power, secretly assisted by other Empires during the cold war that preceded the cataclysm. The terrorists also supplemented their income by taking over the drug trade in the area. By the 21st Century, they were very well armed and equipped, and had the equivalent of a small army hiding in the inhospitable mountain passes.

The Shining Path guerrillas were as unprepared as the rest of the world for the Great Cataclysm. Most of them died horribly in the upheavals that shattered the world. Unlike most other victims, however, the Shining Path had weapons and knew how to use them. They were also in a relatively isolated part of the world, and the mountains suffered much less than the coasts and other parts of the world. The survivors were able to fight off monsters and desperate refugees, and eventually established a small network of “loyal” villages. This loyalty was insured by



massacring entire villages who would not submit to the terrorists' demands.

The return of the Incas shook up the hardened terrorists; to their philosophy, the Empire of the Sun was a "reactionary return to a pre-capitalist, feudal society." The Shining Path declared war on the "superstitious counter-revolutionaries" within a couple of years. Their standard tactics failed miserably; bombs and guns weren't enough against the powerful magicks of the Incas.

Most of the first-generation Shining Path "freedom fighters" were rounded up and imprisoned or killed within a few years. The survivors holed up deep in the mountains, where they swore revenge and raised a new generation of guerrillas and terrorists. That generation marched out and was, in turn, defeated and forced into hiding. For centuries, this situation has remained unchanged. The Shining Path continues to be a threat, especially in the more remote mountain passes. Most are little more than bandits who spout meaningless Marxist ideology while they rob and murder their victims. Many Shining Path bands also deal drugs and/or smuggle illegal weapons and Black Market items on both sides of the Andes. Their raids sometimes hit the smaller kingdoms of the region.

A large branch of the Shining Path (about 2,000 "full-time" guerrillas) also operates in Cordoba, where they are sworn to destroy the "Borges Oligarchy." Many of the Cordoban branch members are D-Bees or mutants who have experienced persecution at the hands of the Cordoba regime. These unfortunates are now bitter, revengeful warriors who care less about a "people's paradise" than about killing those who persecuted them.

The Shining Path operates in a "cell" system. Each cell has 4-20 members. One cell knows very little about the others, so that if a group is captured, they can reveal nothing of importance to the enemy. The supreme leader of the Shining Path goes by the name "Mao Hernandez." There are stories claiming Mao has been around since the Coming of the Rifts, and rumors hinting he may be some sort of immortal, supernatural creature manipulating the movement for his (or its) own ends. Most Shining Path members dismiss these rumors as "capitalist propaganda."

Note: O.C.C.s and R.C.C.s found among the Shining Path includes equivalents of those found in the **Rifts® RPG** (excluding cyber-knights), **Rifts®-Mercenaries** (excluding the Naruni) and **Rifts® World Book Six: South America (one)**.

Italo Industries

Population Breakdown: 50,000 (80% human, 20% assorted D-Bees).

Although not a republic or kingdom, this weapons manufacturer has so much influence and power it rivals or exceeds that of many small nations. "I.I." was founded in 20 P.A. by a team of weapons engineers from Cordoba who left the government-owned weapons manufacturer, *Industrias Militares (I.M.)*. The leader of the "deserters," Jose Italo, was a designing genius, and the fledgling company grew up over the decades until it became one of the largest weapon companies on the continent. Italo Industries is based in **San Luis**, an independent town just South of Cordoba. As it grew, factories and sales offices have been opened in Cordoba, Santiago, the Achilles Republic, and New Babylon. Through New Babylon, Italo Industries has made some

modest sales to the Amaki homeworld, becoming the first Earth company that directly exports to other dimensions!

Italo weapons are sturdy, efficient and reasonably priced. Its most popular weapon line fires ion beams, but the company also produces lasers, rail guns, rocket guns and many conventional weapons. For the most part, the company produces small arms, light vehicles, and civilian products like tools, farm machinery and similar products. It is a point of pride for I.I. employees that many of their weapons end up being used by both sides of a war!

Note: O.C.C.s and R.C.C.s found among the I.I. includes equivalents of those found in the **Rifts® RPG** (excluding cyber-knights), **Rifts® Mercenaries** (excluding the Naruni) and some from **Rifts® World Book Six: South America (one)**.

Nuevo Peru (New Peru)

Population Breakdown: 80,000 (90% human).

This tiny nation-state is based off the pre-Rifts city of Iquitos. Survivors of the Great Cataclysm settled in the region, which is nowadays surrounded by jungle. Nuevo Peru is a river port, linked by a tributary to the Greater Amazon. Its inhabitants rely on technology and distrust and fear magic. They are particularly hostile and suspicious towards the Empire of the Sun, which they consider to be the result of a supernatural invasion. The city and its surrounding villages have managed to defend themselves from attacks by both the Incas and the Arkhons, due mostly to their one notable accomplishment: the discovery (a few years after the Great Cataclysm) of an armory cache that had no less than a full company (160 suits) of USA-G10 Glitterboys!

Thanks to the Glitterboys (89 of them are still active, having been repaired and overhauled dozens of times), New Peru was not absorbed by the larger nations around it, or by the many dangers in the region. Due to their need to maintain their wondrous war machines, the inhabitants of the city have learned a great deal of forgotten pre-Rifts sciences, and unearthed enough industrial equipment to become a self-sufficient state. They are able to repair most robots and vehicles and even manufacture simple weapon systems, mostly for domestic use, but with a small trickle of weapons being exported into the other S.R.R.s.

The city-state, renamed New Peru in an attempt to keep alive the long-dead nation, is a place of technology and human supremacy, not very different from the Coalition or Cordoba. In fact, relations between Cordoba and New Peru are very cordial; each sees the other as another bastion of humanity beset by alien monsters. Cordoba's friendliness goes to the point of allowing a standing army of 5,000 "volunteers" (mostly mercenaries) to be under the orders of the New Peruvian army, who has stationed them along the frontiers with the Empire of the Sun.

The New Peru government is ruled by a military triad; three generals sit on the triad until they die or are deposed by the other two. Most people are relatively happy with their situation, but those who complain are ruthlessly suppressed, arrested, intimidated and even made to "disappear" unless they change their tune.

The Arkhons could still easily crush New Peru, but their losses would be unacceptably high. Warlord Enno is also waiting because New Peru is as much a thorn in the Incas' side as it is in the Arkhons'. A temporary alliance could make New Peru a good tool with which to attack the Empire of the Sun from an-

other front. So far, Arkhon ambassadors have been sent back, unharmed but unheard. Still, the military triad is discussing the possibility of receiving the embassy; two of the generals are still reluctant, not only because the Arkhons are aliens and have attacked them in the past, but also because such a move would cost them the friendship of Cordoba. The third one thinks that the aliens' support is worth more than Cordoba's friendship and a few thousand mercenaries.

Note: O.C.C.s and R.C.C.s found in New Peru includes equivalents of those found in the **Rifts® RPG** (excluding cyberknights), **Rifts® Mercenaries** (excluding the Naruni) and some from **Rifts® World Book Six: South America (one)**.

The Local Caudillos

Population Breakdown: Varies. Includes roughly 10% of the populations of Cordoba and Santiago, and several hundred thousand more (possibly near a million total).

This is not a single nation or kingdom, but rather a number of tiny states, so similar to each other that individual descriptions are not necessary. "Caudillo" is a Spanish word for "leader" or "warlord." For over a century in pre-Rifts history, Caudillos controlled pieces of the South American countryside like the feudal lords of the Middle Ages. With wealth and armed men behind them, the Caudillos laughed at the national government, and did as they pleased in "their" domains. Their word is law, and anybody who displeases them can be disposed of as they wish.

That historical process has repeated itself. Many towns, villages and farmlands are now under the rule of a Caudillo, usually the leader of a band of warriors equipped with power armor, robots, or other advanced weapons. Other Caudillos are mages or psychics who assert control using their powers, but they are much rarer. In the nations of Cordoba and Santiago, Caudillos control almost one-tenth of the population. Typically, the warlords acknowledge the authority of the central government, as long as it doesn't interfere with their own rule. The only way for the government to overthrow a Caudillo is to send an army, but both Cordoba and Santiago have too many problems and threats to afford such actions.

A lot of these small kingdoms are in areas outside the control of any large nations, and are even more totalitarian and brutal. These tiny "nations" are often gobbled up or destroyed by other Caudillos, Larhold barbarians, monsters, and other dangers.

Note: Applicable O.C.C.s and R.C.C.s found under such rule includes equivalents of those found in the **Rifts® RPG** (excluding cyberknights), **Rifts® Mercenaries** (excluding the Naruni), **Rifts® World Book Six: South America (one)**, and, this one, of course.

The South American Devil's Triangle

A powerful ley line triangle is located to the Southeast of the continent. Like the better known "Bermuda Triangle" of the Atlantic Ocean, this dimensional formation is racked by ley line storms, Rifts and similar phenomena. No human ships ever venture there willingly; traffic past the "Hell Peninsula" (*La Peninsula Infernal*, in Spanish), beyond the southern mouth of the Greater Amazon River, is very limited, due to the fact that ships tend to disappear or suffer attacks from creatures from the Rifts.

Languages

The most common languages of South America include:

Spanish: The accent and some grammar are slightly different from the Spanish spoken in Central and North America, but there are no comprehension problems. This is the main language of Santiago, Cordoba, Achilles and *all* the Silver River Republics.

Creole: This combination of Spanish, Portuguese and Amazonian languages is most commonly spoken in the jungle regions of the North, but many travelers in Santiago and some Incas know it. Creole has no official written language; characters with literacy in Creole usually write it down phonetically and spelling varies from writer to writer — any attempt to read a Creole manuscript written by somebody else is at -10% to the skill.

Quechua: This Andean language was the tongue of the original Inca Empire. Quechua did not originally have a writing system, but by the 20th Century it had adopted the common alphabet and could now be read and written. At the time of the Rifts, over 50% of the population of Peru, Ecuador and Bolivia spoke Quechua; many of them spoke no other language. The Empire of the Sun has adopted that tongue as the official language. 70% of the population also speaks Spanish or Aymara, and 40% speaks all three languages!

Aymara: After Quechua, this language was the most commonly spoken native tongue in the Andes region. About 40% of the Empire's population knows Aymara as their native language, and have learned Quechua and Spanish as secondary languages.

Arkhon: This alien language uses sub-vocalized grunts and clicks that only the Arkhons (and, to a lesser degree, the Fallam) can produce. As a result, humans and most other D-Bees and mutants (except feline and canine mutant animals and some aliens) can understand the Arkhons' language at no penalty, but are at -10% to speak it. Outside the Arkhon Freehold, Arkhon is spoken in the Empire of the Sun (usually by military intelligence officers) and some Silver River Republics; typically learned from renegade Arkhons, and is used by military personnel and by the few traders who do business with the aliens.

Larhold: The language of these barbarians is extremely hard to master (base skill is 40% plus 4% per level of experience for all races but the Larhold, who learn it normally). Also, the Larhold never teach it to outsiders. Only members of the tribe, be it renegades or true Larhold, are ever taught it. Slaves are forbidden to learn the tongue, and killed even if they are suspected of understanding it. If a player wants his character to know this language, he must come up with a story explaining how the character managed to learn it.

Others: Less than 10% of the people understand or speak American, and under 2% speak Euro, Chinese, Japanese, Gobbely or Faerie speak. About 15% speak and understand Dragonese/Elf.

Weapons & Equipment of the S.R.R.

NP-10 Plasma Net Launcher (Cordoba)

This weapon was developed in Cordoba as a way to deal with supernatural beings, monsters and other dangerous enemies. The weapon looks like a single-shot grenade launcher with a 50mm bore. The missile it fires opens up in mid-air, becoming a net made up of mega-damage metal strands. The metal is a special alloy that can burn explosively if exposed to the right temperatures. Small plasma charges are placed all throughout the net. As soon as a person or object is entangled, the plasma charges ignite and the net starts burning at ultra-hot temperatures, consuming itself (and the target) within a minute.

The NP-10 is typically issued to Cordoba patrol units, but is also on sale on the civilian market; hunters and wilderness scouts like the weapon, especially since it immobilizes targets even as it consumes them.

Weight: 8 lbs. (3.6 kg)

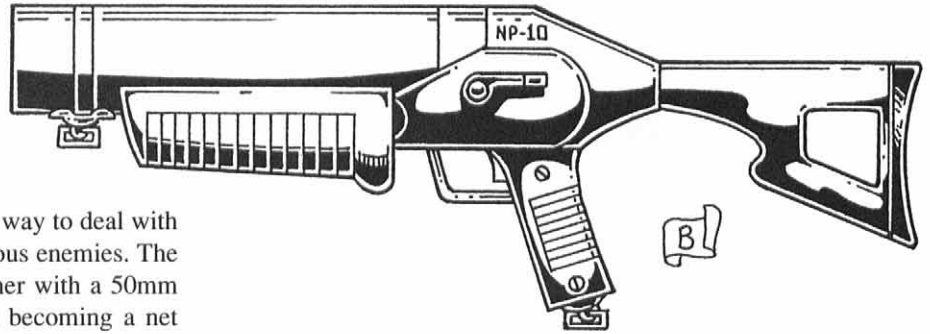

Mega-Damage: Special: The net entangles the victim (it takes four melee actions/attacks to untangle oneself, half that for beings with supernatural P.S. 40 or greater), and then bursts into flames, inflicting 4D6 M.D. for 1D4 melee rounds, at which time the net is completely consumed. Meanwhile, the victim cannot strike or parry, is at -2 to dodge, and moves at a speed of 4!

Rate of Fire: Each shot counts as one melee attack/action.

Effective Range: 500 feet (152 m)

Payload: One shot only; a bandoleer holds 20 net-grenades.

Cost: 20,000 credits. Each net-grenade costs 300 credits.

IP-7 Ion Pistol (Cordoba/Santiago)

The IP-7 is commonly issued to soldiers in the Cordoba and Santiago armies. It is even used by the militia of the Achilles Republic! Italo Industries, a large weapons manufacturer, sells its wares to anybody with the cash. See the *Other Republics* section for more information. IP-7s are carried by officers, security officers, and is also issued as a back-up gun to line soldiers.

Weight: 3 lbs. (1.35 kg)

Mega-Damage: 2D6 M.D.

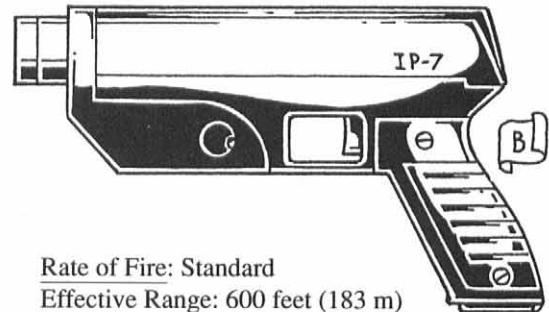

Rate of Fire: Standard

Effective Range: 600 feet (183 m)

Payload: 12 shots.

Cost: 15,000 credits.

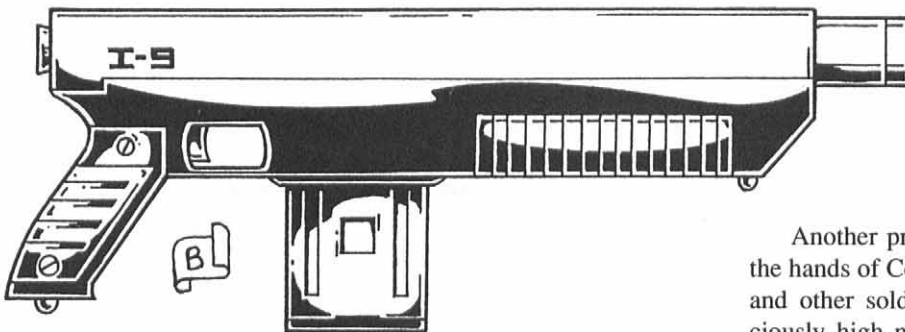

Weight: 8 lbs. (3.6 kg)

Mega-Damage: 4D6 M.D.

Rate of Fire: Standard

Effective Range: 2000 feet (610 m)

Payload: 20 shots.

Cost: 20,000 credits.

I-9 Heavy Ion Rifle (Cordoba/Santiago)

Another product of Italo Industries, the I-9 can be found in the hands of Cordoba soldiers, many units of the Santiago Army, and other soldiers and adventurers on the continent. A suspiciously high number of these weapons have also been sighted with the Shining Path guerrillas (see the *Other Republics* section). The Cordoba authorities are beginning to suspect that Italo Industries has been selling the weapons to those guerrilla fighters.

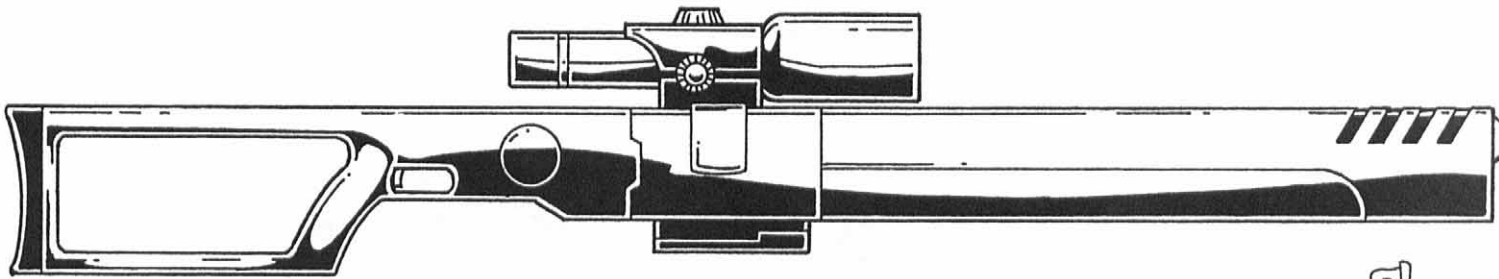

I-11 Long Gun (Cordoba/Santiago)

This weapon is meant to be used as a sniper rifle or heavy hunting rifle, and is a favorite among assassins, sharpshooters, and the plains 'borg. Its main drawbacks are its length (almost six feet/1.8 m long) and weight, which makes it difficult to carry. The plains 'borgs, who rely on their cybernetic horses, have no such problem and love to tote these long rifles along.

The enhanced sights of these rifles give a +1 to strike on aimed shots.

Weight: 28 lbs. (12.6 kg)

Mega-Damage: 1D6×10 M.D. per blast!

Rate of Fire: Single shots only (each counts as one melee attack).

Effective Range: 4000 feet (1220 m)

Payload: 10 shots.

Cost: 50,000 credits.

B

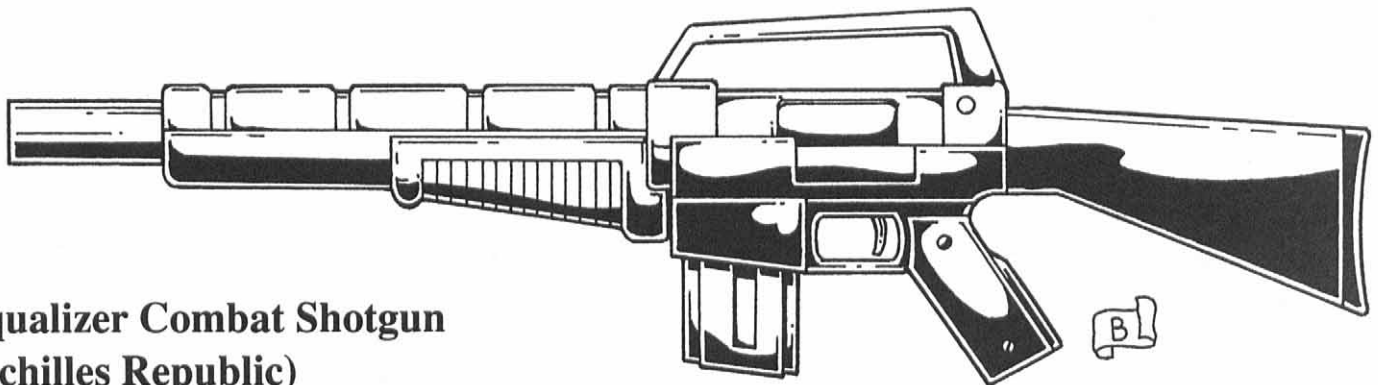

Equalizer Combat Shotgun (Achilles Republic)

The Equalizer is a smooth-bore, semi-automatic shotgun that fires 16mm explosive cartridges. The gun can also fire regular 12 gauge shotgun shells, flares, and smoke or tear gas grenades, making it a very useful multi-purpose weapon. Also, the weapon is incredibly rugged and durable, designed to function even after being submerged in a swamp or in mud for 24 hours, plus it is highly resistant to water damage and other environmental hazards. The Equalizer is manufactured in the Achilles Republic, and is one of the few weapons that is exported abroad; the Amaki traders from New Babylon have started selling the weapon across several dimensions. Santiago has also bought several thousand of these weapons for use by the militia. Cordoba weapon makers have manufactured a cheap knock-off (reduce damage of the 16mm explosive cartridges to 4D6 M.D. and range to 500 feet/152 m) for the use of the National Guard and private individuals.

Standard 12-gauge slugs: 5D6 S.D.C. Cost: 2 credits per round.

16mm Armor Piercing Explosive (APE): 5D6 M.D. (no blast radius). Cost: 100 credits per round.

16mm Fragmentary Grenade (FG): 2D4 M.D. to a 10 feet/3.0 m blast radius. Cost: 500 credits per round.

16mm Smoke: Blocks vision in a 20 feet/6.1 m radius. Cost: 100 credits per round.

16mm Tear Gas: Save vs non-lethal poison or blinded (-6 to strike, parry or dodge in either case). 20 feet/6.1 m radius. Cost: 200 credits per round.

Rate of Fire: Each shot counts as one melee attack. Cannot fire bursts.

Effective Range: 1,000 feet (305 m) for 16mm rounds, 300 feet (91.4 m) for regular shotgun rounds.

Payload: Box magazine: 10 rounds. Drum magazine: 20 rounds. Can use either type.

Cost: 12,000 credits. Ammunition costs are listed above.

B

Weight: 10 lbs. (4.5 kg)

Mega-Damage: Varies with cartridge type. The most common include:

Standard 12-gauge buckshot: 4D6 S.D.C. Cost: 1 credit per round.

Lightbringer Laser Rifle (Achilles Republic)

This is a compact, bull-pup configuration laser rifle with a long carrying handle, somewhat similar to the M-16's, but running the length of the short rifle (to allow mutants with larger than human hands to carry them with comfort). Some 50% of the Achilles soldiers use this weapon (the other half use Equalizer shotguns or personalized energy weapons).

Weight: 6 lbs. (2.7 kg)

Mega-Damage: 4D4 M.D. per single blast or 1D4×10+10 M.D. per multiple pulse burst (3 simultaneous shots).

Rate of Fire: Standard.

Effective Range: 2000 feet (610 m)

Payload: 30 shots.

Cost: 15,000 credits

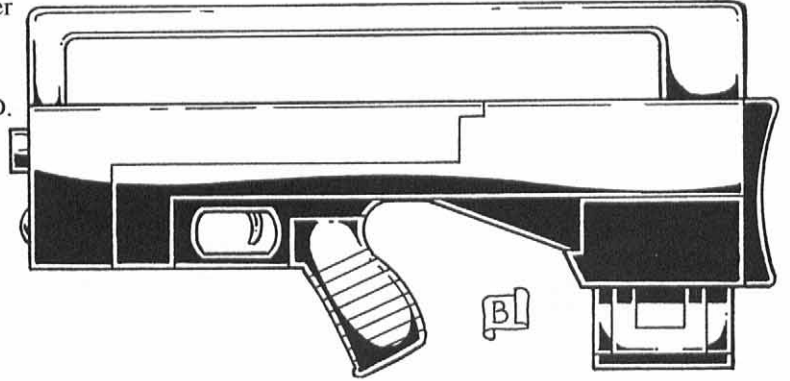

Amaki Blast-Sword (New Babylon)

The Amaki blast-sword looks like a blunt fencing weapon. Its handle is at an angle with the "blade," a bit like a pistol grip but not too different from some types of fencing foils. This weapon can fire plasma discharges, and it can also run a continuous plasma stream, held in place by a magnetic field along the blade. The plasma blade is a devastating M.D. weapon, and yet is so light it can be wielded quickly and easily by a fencing enthusiast.

This weapon is a favorite among the people of New Babylon, who admire and practice swordsmanship. Almost every middle-class or higher male citizen (and many females) carry one of these weapons, both as a symbol of status and as a means of self-defense. Most models are richly decorated, with golden and gold-plated handguards, pommels, and scabbards, some are even studded with jewels.

Weight: 4 lbs. (2.2 kg)

Mega-Damage: Plasma Discharge: 3D6 M.D. Plasma Blade: 2D6+6 M.D.

Rate of Fire: Equal to the number of hand to hand attacks per melee.

Effective Range: Plasma Discharge: 500 feet (152 m). Plasma Blade: Hand to hand combat.

Payload: 20 shots; if every shot is fired, the plasma blade becomes inert until a new E-clip is inserted. Each "shot" can keep the plasma blade active for 10 minutes.

Cost: 25,000 credits; higher for the better decorated models. Most well-to-do Babylonians spend a small fortune in those blades.

Amaki Blast Rifle

This is the standard issue military rifle of the New Babylon Army. A few thousand rifles have also been sold to the Empire of the Sun and the Achilles Republic. The weapon fires a "packet" of charged particles, exploding on impact. The gun is richly decorated, and the barrel is often shaped like a fish, a snake or dragon, with an opened mouth for the muzzle of the gun.

Weight: 10 lbs. (4.5 kg)

Mega-Damage: 6D6 M.D. per blast.

Rate of Fire: Single shot only.

Effective Range: 2000 feet (610 m)

Payload: 15 shots

Cost: 20,000 credits

Amaki TW Psi-Blade (New Babylon)

A product of Amaki Techno-Wizardry, the psi-blade enhances the psychic energies that create the feared psi-sword. The weapon can only be used by master psionics who have that power, but its effects are devastating. The few cyber-knights who have gotten their hands on the psi-blade have become fearsome fighters. Most of these weapons are used by the Amaki Duelists (see the *Duelist O.C.C.*). These feared swordfighters and assassins can also extend psi-swords, and are extensively trained with the TW psi-blade. In most places of South America, ownership of one of these weapons is enough to brand the user a

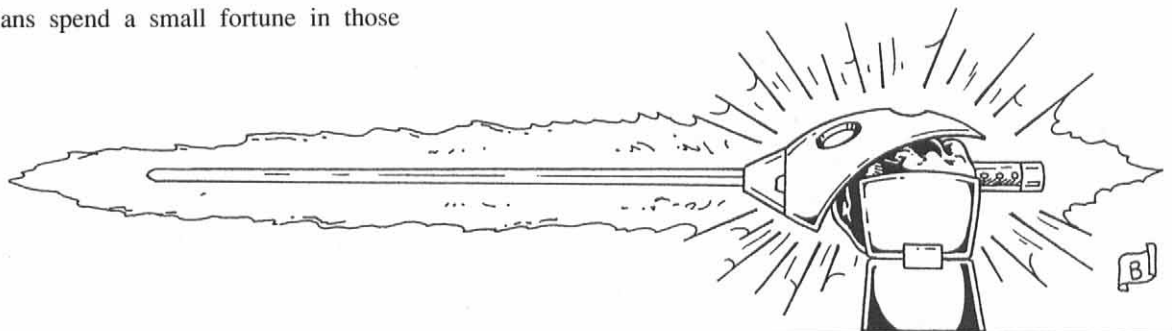

New Babylonian and/or a Duelist —either of which is enough to get the character in a lot of trouble.

Weight: 3 lbs. (1.35 kg)

Mega-Damage: Varies; the psi-blade adds 2D6 M.D. to the damage caused by the psi-sword! For example, a 5th level Mind Melter (normal psi-sword damage 6D6 M.D.) would inflict 8D6 M.D. while using a TW psi-blade, while a 3rd level cyber-knight

would do 4D6 M.D. instead of the traditional 2D6 M.D.

Rate of Fire: Not applicable.

Effective Range: Hand to hand combat.

Payload: I.S.P. cost is the same for the super-psionic power; cyber-knights and duelists must spend 2 I.S.P. per minute to activate the weapon.

Cost: 30,000 credits.

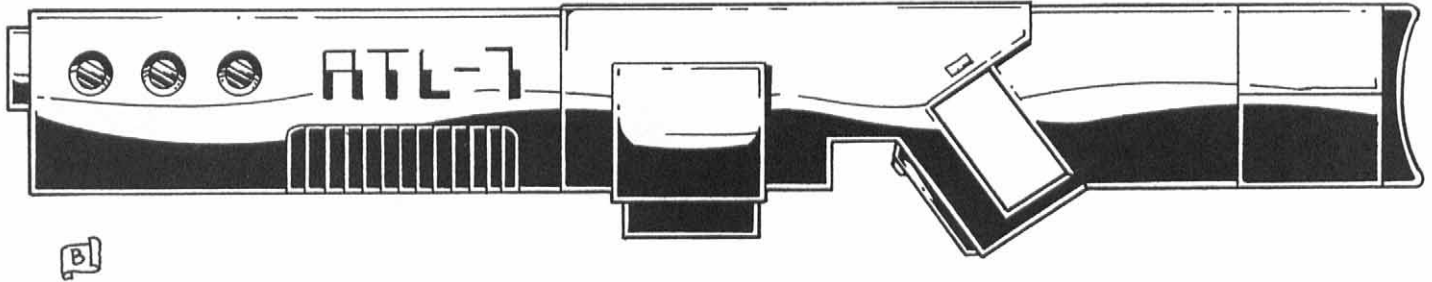

ATL-7 Anti-Tank Laser Rifle

This is a pre-Rifts design built to give infantrymen a chance against the armored behemoths that were dominating the battlefield. It is a one-shot weapon that releases all the energies contained in a normal E-clip in one single shot! The shortcomings of this powerful weapon are that it must be reloaded by hand (takes two melee actions to reload after firing), and that it's so heavy (the barrel is thick with insulation to protect against the heat) that it takes two normal humans to carry it (cyborgs and power

armor troopers can use it as a rifle without trouble). Also, they use up E-clips so fast that only large organizations or wealthy characters can afford to equip themselves with it.

Weight: 30 lbs. (13.5 kg)

Mega-Damage: 3D6×10+20 M.D. per shot!

Rate of Fire: Single shot only; each shot empties an entire E-Clip!

Effective Range: 3000 feet (914 m)

Payload: 1 shot per E-Clip

Cost: 100,000 credits; poor availability.

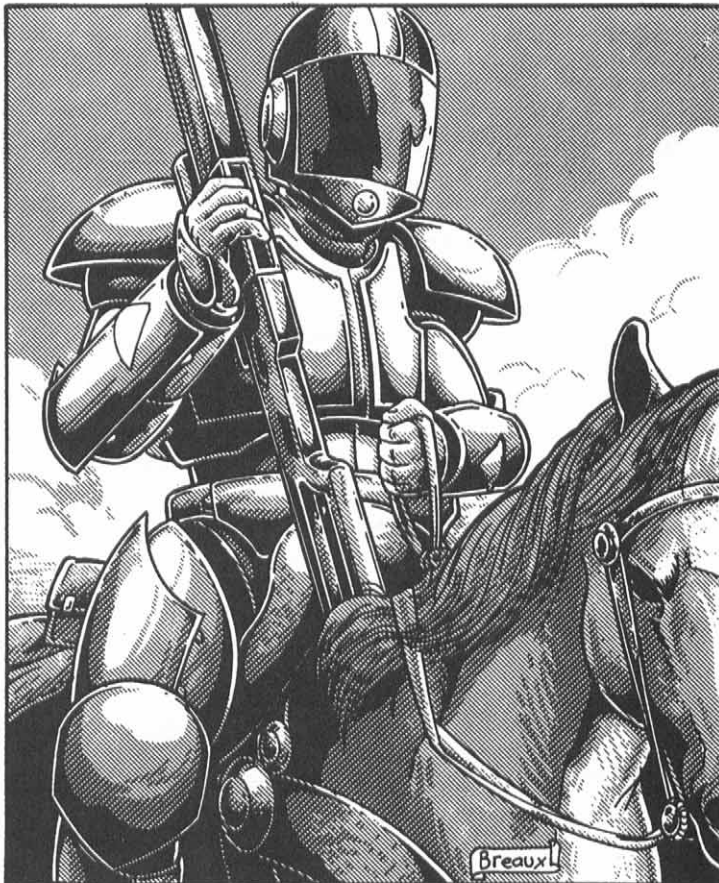

Body Armor

Gauche Combat Armor

This is a popular model designed to be used by horsemen or bike riders. The back of the legs and rear are covered with grip padding, making it more comfortable to ride for several hours at a time. Internal padding also helps lessen the shocks of riding. The armor is modular, consisting of a lighter inner layer on which heavier plates can be added. The heavier plates are used when riding on horseback or motorcycles, and provide the maximum protection available to non-powered armor. However, they are heavy and cumbersome if the character is moving on foot. When stealth and speed are important, the plates are removed. The lighter armor offers less protection but minimal encumbrance. Besides the plainsmen it's named for, the armor is favored by guerrillas, adventurers and bandits.

- M.D.C. 45 for the inner layer; 100 if the outer plates are added on.
- Weight: 14 lbs. (6.3 kg) (inner layer alone); 40 lbs. (18 kg) (plates)
- Variable mobility: -5% prowl with inner layer alone; -30% prowl penalty when wearing the heavy plates. Plus the character is at -1 to all combat actions if fighting on foot while wearing heavy armor.
- Cost: 40,000 credits

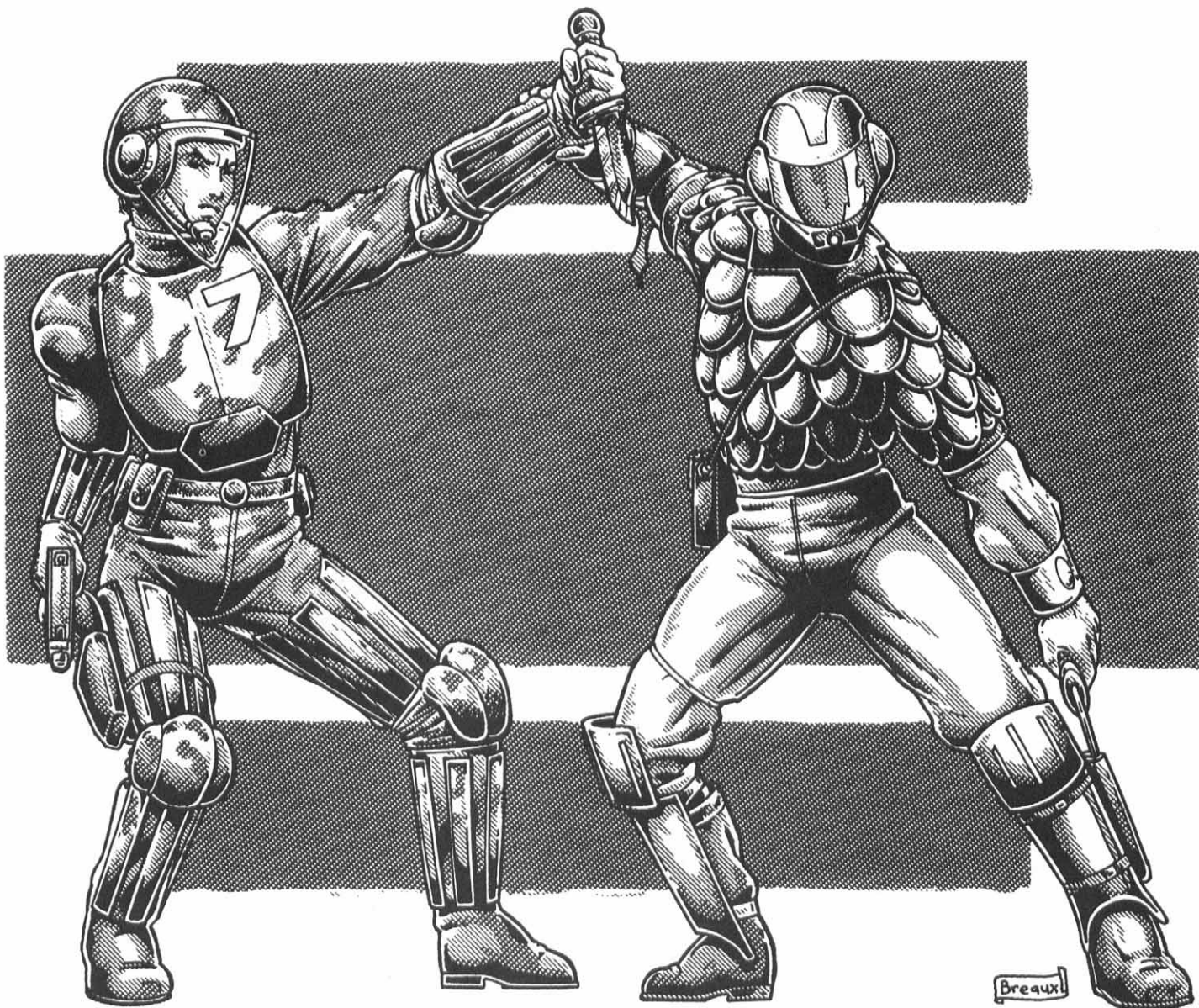

Battle Infantry Armor (Cordoba)

Based on pre-Rifts military armor, this is the standard combat armor used by the Cordoban army. The armor consists of fatigues with a solid breastplate protecting the torso area, a helmet with a transparent face plate, and vertical strips protecting the legs and forearms. Copies and stolen suits are also worn by bandits, guerrillas and adventurers, and sold on the black market. Official colors are khaki and camouflage patterns; black market suits are painted in all kinds of colors.

- M.D.C. 60
- Weight: 22 lb. (9.9 kg)
- Fair Mobility: -15% prowl penalty.
- Black Market Cost: 30,000 credits.

Armored Fatigues (Santiago)

Santiago's armed forces are equipped with this armored uniform, another knock-off of a pre-Rifts model. Like the Cordoban version, the armored fatigues consist of a reinforced jump-suit. The armor consists of overlapping scales covering the chest and upper arms, with solid shin guards protecting the legs. A fully enclosed helmet protects the head. Santiago's armed forces paint

the armor in green or black; civilian models are sold legally but have less M.D.C.

- M.D.C. 65 (50 for civilian models)
- Weight: 24 lb. (10.9 kg)
- Fair Mobility: -15% prowl penalty.
- Cost: 35,000 credits

Duelist Articulated Armor (New Babylon)

This armor is a masterpiece of Amaki technology, plates so closely fitted to the wearer's body and so well articulated that it acts as a second skin, with no encumbrance. The armor is manufactured through nano-technology, and is *customized* for each wearer. Likewise, the helmet design can be modified to suit the owner's tastes, from functional, common shapes, to fanciful designs with crests, horns, plumes, and other decorations. Amaki duelists wear these suits almost exclusively; the fit is so close that it can be worn concealed under capes, loose-fitting robes and other bulky clothing (but cannot be worn under other types of body armor). The armor is incredibly expensive, costing almost as much as a suit of powered armor.

Power Armor & Robots

Mecha-Lizard Power Armor

Blood Lizards are respected and feared throughout the plains of the Silver River Republics. These intelligent predators superficially resemble velociraptors and similar bipedal, predatory dinosaurs of Earth's primordial past (for more information on Blood Lizards, refer to the **Blood Rider O.C.C.** and **Blood Lizard R.C.C.**). It was only natural that weapon designers in the Republic of Santiago would incorporate the qualities of this dangerous beast into one of their combat power armor suits. The re-

- M.D.C. 75
- Weight: 10 lbs. (4.5 kg)
- Full mobility; no prowl penalty!
- Market Cost: 120,000 credits. Refitting a suit that used to belong to someone else costs 20,000 credits.

Blood Rider "Claw" Armor

This stylized body armor looks as if it was made of overlapping teeth, claws or bones. Blood Riders always wear them, most often painted red. Non-Blood Riders who use the armor risk angering and offending the "real guys."

- M.D.C. 65
- Weight: 18 lb. (8.1 kg)
- Good Mobility: -8% prowl penalty
- Cost: 35,000 credits

Amaki Combat Armor (New Babylon)

The heavy gear favored by the military forces of New Babylon. The armor consists of thick plates, well balanced and articulated. The helmet has a protruding, lower "jaw" to accommodate

the Amaki's "beards." Most models also have a metallic "crest" running down the center of the helmet. New Babylon sells these suits on the open market; some humanoid military units in Achilles use this suit instead of the standard issue (see below).

- M.D.C. 90
- Weight: 20 lbs. (9 kg)
- Good mobility: -8% prowl penalty.
- Market Cost: 50,000 credits.

Customizable Armor (Achilles Republic)

Given the variety of mutant animals that live in the Achilles Republic, the weaponsmiths of the nation decided to make a suit of armor that could easily be modified to fit as many different shapes as possible. The result was an extremely flexible suit, capable of being quickly adjusted to fit any being from 4 to 8 feet (1.2 to 2.4 m) tall, and in a wide variety of widths, limb lengths, and add-ons to accommodate tails, and extra limbs and wings. The armor is used not only by mutant animals, but also by D-Bees such as wolfen, ogres and other humanoids.

- M.D.C. 75
- Weight: 25 lbs. (11.25 kg)
- Fair mobility: -15% prowl penalty.
- Market Cost: 45,000 credits

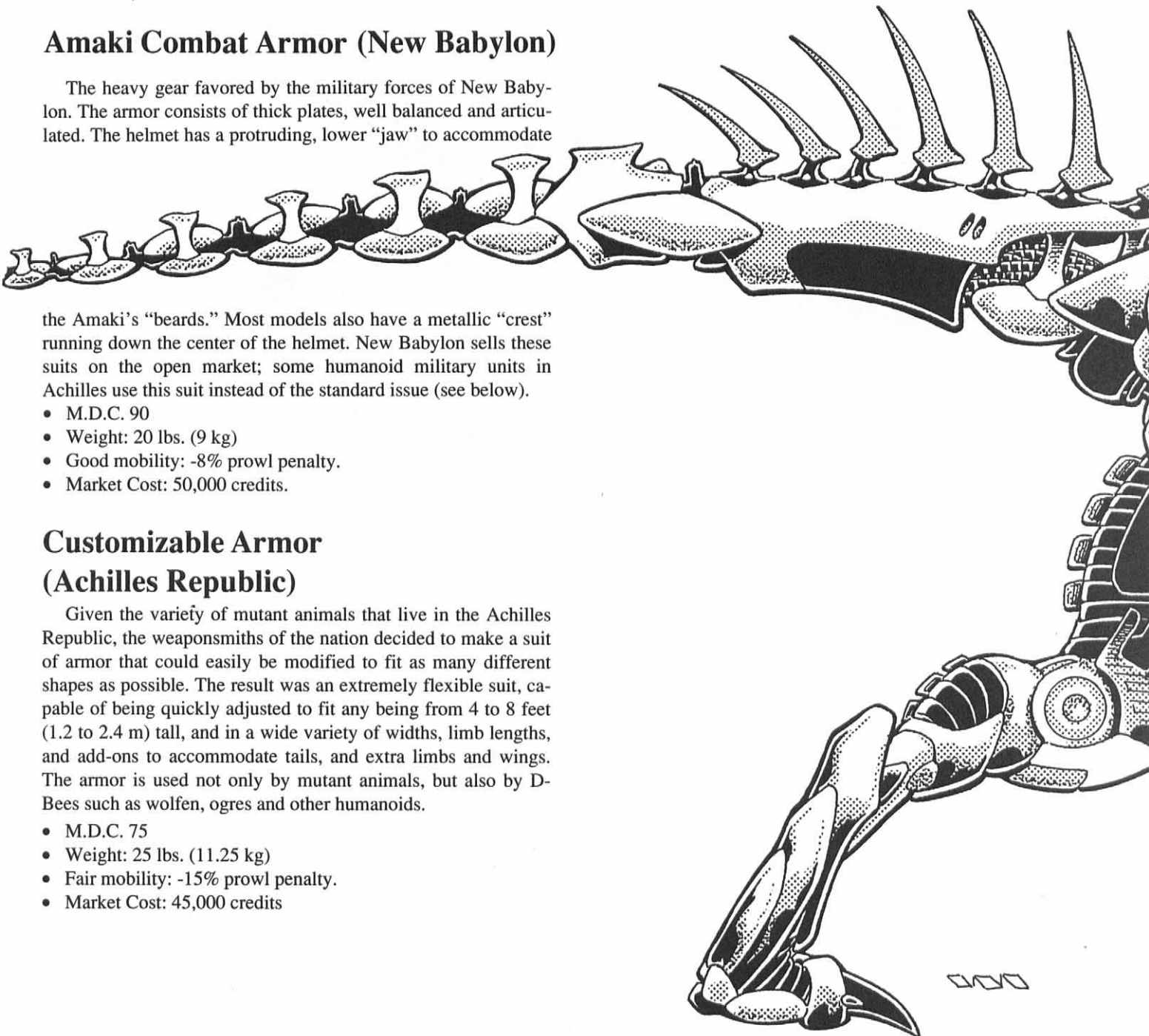

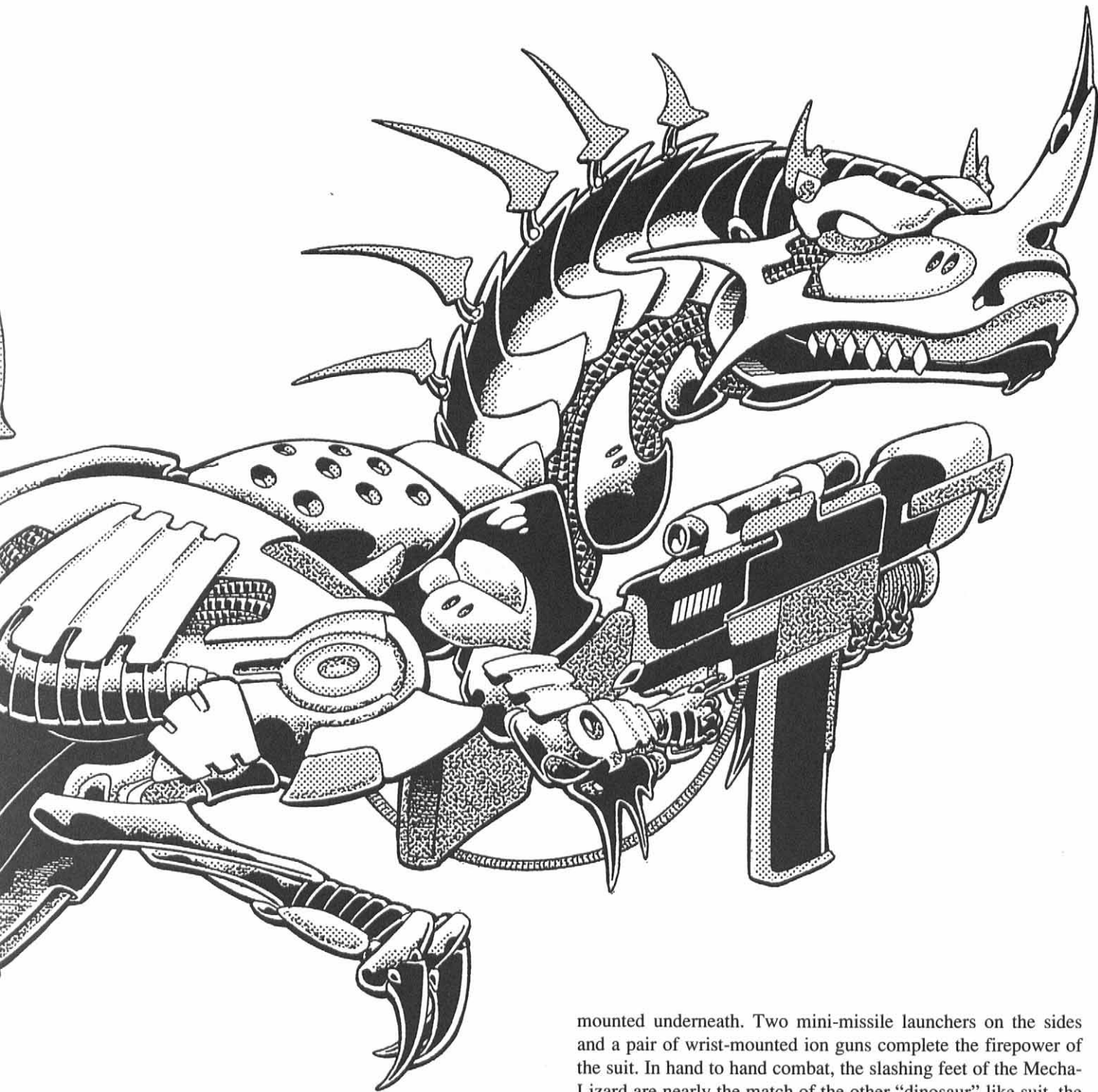

sulting product has proven to be very popular, especially among wannabe Blood Riders who, deprived of the chance to bond with a real beast, can now ride inside a mechanical simulation of one.

Like Blood Lizards, the Mecha-Lizard can carry hand weapons, and the standard model comes with a rifle-shaped weapon that combines a heavy laser with a rocket/mortar launcher

mounted underneath. Two mini-missile launchers on the sides and a pair of wrist-mounted ion guns complete the firepower of the suit. In hand to hand combat, the slashing feet of the Mecha-Lizard are nearly the match of the other "dinosaur"-like suit, the Kittani Raptor PA (see *Rifts South America: One*). Additionally, the weapon engineers of Santiago equipped the Mecha-Lizard with a sonic pulse weapon that simulates the blood-curdling scream of the real creature. Whereas the cry of the Blood Lizard simply scares its prey, the mechanical one's yell can crack mega-damage materials and will deafen and stun most living things!

The Mecha-Lizard is used by the Santiago Army, and can also be found among adventurers, mercenaries and retainers throughout the region. The Cordoba government purchased 100 Mecha-Lizards when relations between the two countries were friendlier. It is now likely that soldiers from both sides of the war will be piloting the same robot.

Model Type: PA-10ML

Class: Heavy Infantry Assault Exoskeleton

Crew: One

M.D.C. by Location:

Hands (2) — 30 each

Arms (2) — 120 each

Rifle-Mounted Multi-Weapon — 160

Legs — 200 each

Mini-Missile Launchers (2, on the sides) — 80 each

* Tail — 100

** Head — 120

*** Main Body — 320

* Destroying the tail will unbalance the Mecha-Lizard, causing a -1 penalty to dodge, and reducing running speed by 20%.

** Destroying the head destroys the sonic weapon, and destroys all forms of optical enhancement and sensory systems. The pilot must now rely on his own vision and senses. No power armor combat bonuses to strike, parry and dodge! The head is a small and difficult target to hit. It requires a called shot and even then the attacker is -4 to strike.

*** Depleting the M.D.C. of the main body destroys the vehicle, rendering it useless.

Speed

Running: 80 mph (129 kmph) maximum. Cruising speed is 60 mph (96 kmph). The legs are wholly artificial; the act of running does not fatigue the pilot.

Flying: Not possible.

Leaping: The powerful robot legs allow for a 20 foot (6.1 m) standing still leap, or up to 40 feet (12.2 m) with a running start.

Statistical Data:

Height: 9 feet seven inches (2.9 m).

Width: 6 feet (1.8 m).

Length: 20 feet (6.1 m) from head to tail.

Weight: One ton.

Physical Strength: Equal to a P.S. 30

Cargo: None.

Power System: Nuclear; average energy life is 15 years.

Market Cost: 10 million credits.

Weapon Systems

1. Multi-Weapon: This huge rifle-like weapon features a heavy infantry laser mounted over a heavy grenade launcher (a mortar for most intents and purposes) with a long magazine. The laser is connected by an extension cord to the armor's nuclear power plant, allowing it to fire indefinitely. The weapon can double as both an anti-tank and anti-personnel system.

Primary Purpose: Anti-tank

Secondary Purpose: Anti-personnel

Mega-Damage: Laser: 1D6×10 M.D.; Grenade Launcher: 4D6 M.D. to a 20 foot (6.1 m) area (fragmentary) or 6D6 M.D. to a 6 foot (1.8 m) area (armor-piercing).

Rate of Fire: Equal to the number of hand to hand attacks per melee of the pilot.

Effective Range: Laser: 2000 feet (610 m). Grenade Launcher: 3000 feet (914 m).

Payload: Laser: Effectively unlimited. Grenade Launcher: 20 rounds.

2. Sonic Pulse Cannon: This innovative weapon system is hidden beneath the mechanical jaws of the power armor. It generates a matter-destroying beam of concentrated sound waves. In its "wide beam" setting, it can stun and hurt a lot of infantrymen at once; its concentrated beam can shatter most armor in seconds.

Primary Purpose: Anti-armor and anti-personnel.

Secondary Purpose: Defense

Mega-Damage: Wide Beam: 4D6 M.D. to a 30 feet (9.1 m) diameter. Concentrated Beam: 1D4×10 M.D. Additionally, unprotected personnel must make saves vs non-lethal poison (16 or higher) or be stunned for 1D4 melee rounds. People in sealed suits only fail their save if they do not roll an 8 or higher. The targets of a concentrated blast must make a standard save versus non-lethal poison even if inside a suit of power armor, due to the focus and power of the concentrated blast.

Rate of Fire: Equal to the combined number of hand to hand attacks per melee.

Effective Range: 500 feet (152 m)

Payload: Effectively unlimited.

3. Mini-Missile Launchers (2): These side-mounted missile boxes are used for long-range attacks, as well as to engage airborne targets.

Primary Purpose: Anti-aircraft and anti-armor.

Secondary Purpose: Defense

Mega-Damage: Varies with missile type. Commonly uses plasma (1D6×10 M.D.) or armor-piercing (1D4×10 M.D.).

Rate of Fire: One at a time, or in volleys of two, four, six, eight or sixteen missiles.

Effective Range: About one mile (1.6 km).

Payload: 16 total; eight per launcher.

4. Wrist Ion Blasters (2): These short-ranged weapons are used mostly as back-ups, should the main carried gun become inoperable or is lost. Some soldiers also use the weapons on targets "unworthy" of the big guns, such as lightly armored infantrymen.

Primary Purpose: Anti-personnel

Secondary Purpose: Defense.

Mega-Damage: 3D6 M.D. per blast.

Rate of Fire: Equal to the number of combined hand to hand attacks of the pilot.

Effective Range: 300 feet (91.4 m)

Payload: Effectively unlimited.

5. Hand to Hand Combat: Rather than use a weapon, the pilot can engage in mega-damage hand to hand combat.

Power Armor Bonuses:

+1 attack per melee at levels one, seven and fourteen; in addition to those of the pilot.

+1 to dodge at levels one, four, eight and twelve.

+2 to roll with punch, fall or impact.

+3 to pull punch.

Critical strike, same as the pilot's.

Mega-Damage:

Bite Attack — 1D6 M.D.

Clawed Hand Attack — 3D6 M.D.

Power Hand/Claw Attack — 1D4×10 M.D. (counts as two attacks)

Clawed Kick Attack — 5D6 M.D.

Leap Kick or Power Kick — 1D6×10 M.D. (counts as two attacks)

Toro “Minotaur” Power Armor (Cordoba)

“El Toro” implements the strength and power of the bull in its design. This relatively new power armor (only in production for ten years) is massive, strong and fast. An infantry model, the Toro is designed to assault enemy positions, firing its missile launchers, horn lasers and forearm-mounted ion guns, and then closing in and striking the enemy with its energy axe. Squads of 4-6 troopers typically use a tactic, with half of the team advancing while the other half fires from cover to suppress the enemy.

The suit is built along humanoid lines, but the head/helmet is shaped like a bull. The horns are actually powerful lasers designed to fire devastating double blasts. Each shoulder holds twelve mini-missiles, and a pair of heavier medium-range missiles are inside launch tubes mounted on the back. Two ion blasters are mounted on the forearms. Typically, the Toro carries an energy axe, but it can be replaced by rail guns, heavy lasers and similar power armor weapons.

The Cordoba military has thousands of these suits in service. A few hundred are owned by wealthy landowners, although the Borges government makes sure that no rancher has more than half a dozen of these powerful suits — should a “nobleman” try to break this unwritten law, the government would come down on him, hard and fast. More than one landholding was razed to the ground as punishment for this violation.

Model Type: TPA-7

Class: Heavy Assault Exoskeleton

Crew: One

M.D.C. by Location:

Medium-Range Missile Tubes (2, in back) — 25 each

Mini-Missile Launchers (2, in shoulders/upper chest) — 40 each

Hands (2) — 60 each

Arms and Ion Blasters (2) — 230 each

Energy Axe — 150

Legs (2) — 300 each

* Head (reinforced) — 200

** Main Body — 450

* Destroying the head of the power armor will eliminate all forms of optical enhancements and sensory systems. The pilot is forced to rely on his own vision and senses. All power armor combat bonuses are lost. The horn lasers are also lost. Hitting the head requires a called shot at -3 to strike.

** Depleting the M.D.C. of the main body will shut the armor down completely, making it useless.

Speed

Running: 70 mph (112 kmph)

Leaping: The powerful robot legs allow for a 15 foot (4.6 m) standing still leap, or up to 30 feet (9.1 m) with a running start.

Flying: Not possible.

Statistical Data

Height: 9 feet (2.7 m)

Width: 6 feet (1.8 m)

Length: 4 feet (1.2 m)

Weight: One ton (2,000 lb.)

Physical Strength: Equal to a P.S. 45

Cargo: None.

Power System: Nuclear; average energy life of 15 years.

Market Cost: 8 million credits.

Weapon Systems

1. Ion Blasters (2): These ion beams are built into the forearms.

They can be used against individual targets or combined for a devastating double blast.

Primary Purpose: Assault

Secondary Purpose: Defense

Mega-Damage: 1D4×10 M.D. per single blast or 2D4×10 M.D. per simultaneous double blast.

Rate of Fire: Equal to the number of hand to hand attacks of the pilot.

Effective Range: 1000 feet (305 m)

Payload: Effectively unlimited.

2. Mini-missile Launchers (2): These launchers are located on the shoulders and upper chest area. A reload is kept inside the armor itself; an empty launcher will reload itself in one melee round (15 seconds).

Primary Purpose: Anti-armor and anti-personnel.

Secondary Purpose: Defense

Mega-Damage: Varies with missile type.

Rate of Fire: One at a time, or in volleys of two, four, six or twelve missiles.

Effective Range: About one mile (1.6 km).

Payload: 24 total, 12 per launcher.

3. Medium-Range Missiles (2): Two missile tubes are mounted on the back, giving the Toro the capability to strike targets dozens of miles away.

Primary Purpose: Anti-armor and anti-aircraft

Secondary Purpose: Defense

Mega-Damage: Varies with missile type.

Rate of Fire: One at a time, or in volleys of two missiles.

Effective Range: 40 to 80 miles (64 to 128 km)

Payload: Two medium-range missiles.

4. Laser Horns: The horns are actually powerful lasers designed to fire devastating double blasts.

Primary Purpose: Assault

Secondary Purpose: Defense

Mega-Damage: 4D6 M.D. per single blast or 1D4×10+8 M.D. per simultaneous double blast.

Rate of Fire: Equal to the number of hand to hand attacks of the pilot.

Effective Range: 2000 feet (610 m)

Payload: Effectively unlimited.

5. Energy Axe: The major close combat weapon of the Minotaur is its energy axe, a design copied from New Babylonian weapons. A plasma field is held by a magnetic field on the “edge” of the huge axe. The plasma field will cut through most M.D.C. materials with ease.

Primary Purpose: Anti-armor

Mega-Damage: 1D4×10 M.D. if powered; 1D6 M.D. blunt damage otherwise.

Rate of Fire: Equal to the number of hand to hand attacks of the pilot.

Effective Range: Hand combat.

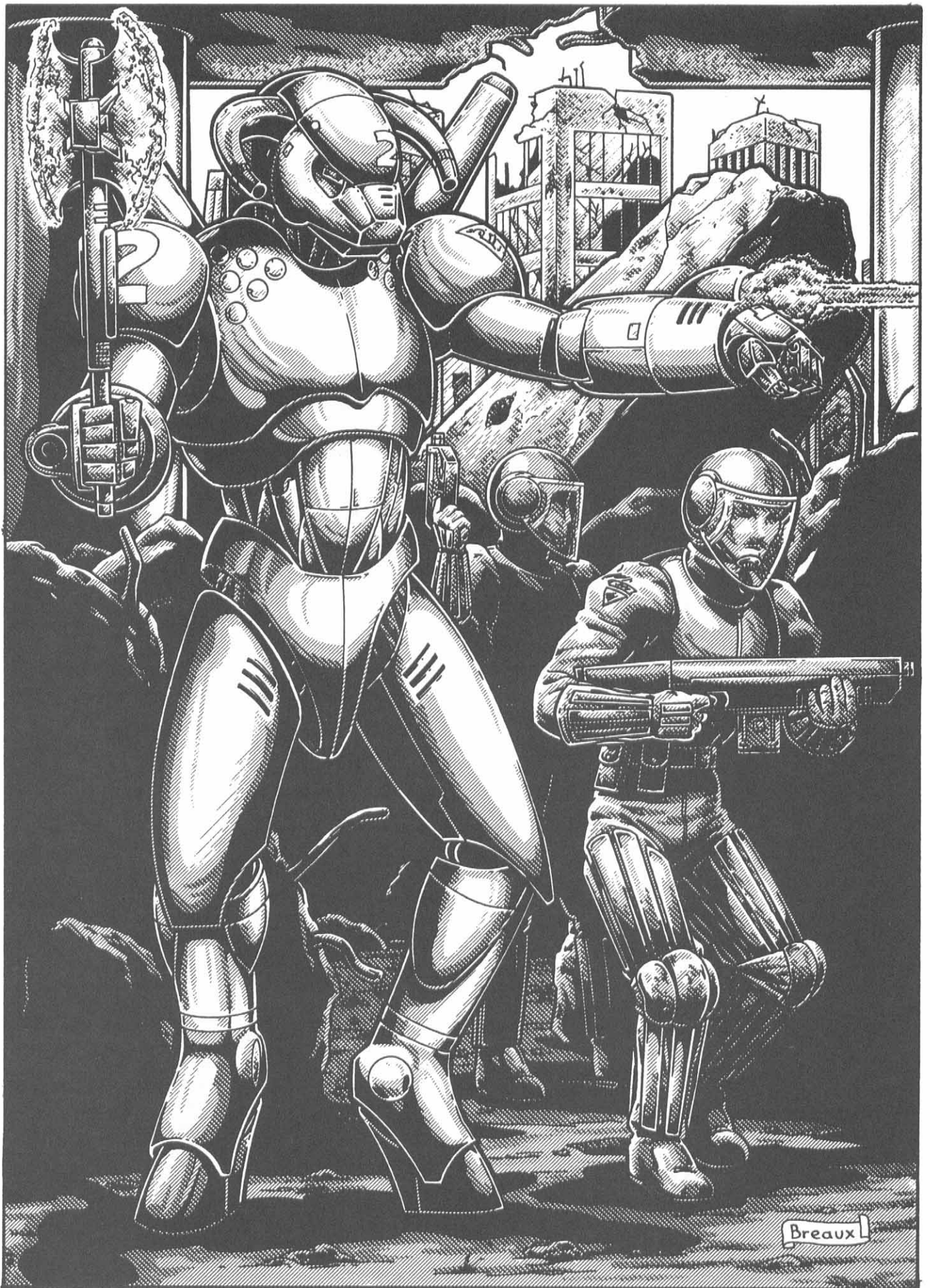

Payload: Effectively unlimited; the energy edge is powered by the suit's power plant.

6. Other Energy Weapons: Heavy lasers, rail guns, machineguns, etc., can be substituted for the energy axe.

7. Hand to Hand Combat: Rather than use a weapon, the pilot can engage in mega-damage hand to hand combat.

Power Armor Bonuses:

+1 attack per melee at levels one and seven; in addition to those of the pilot.

+1 to parry.

+1 to dodge at levels one, six and twelve.

+3 to roll with punch, fall or impact.

+3 to pull punch.

Critical strike, same as the pilot's.

Mega-Damage:

Restrained Punch — 1D4 M.D.

Full Strength Punch — 2D6 M.D.

Power Punch — 4D6 M.D. (counts as two attacks)

Kick Attack — 3D6 M.D.

Leap Kick or Power Kick — 6D6 M.D. (counts as two attacks)

Head Butt/Jab with horns — 2D4 M.D.

Glitter Boy Number 7

Glitter Boys made their devastating debut in world affairs in South America (see *Rifts RPG*, page 128). A large number of countries in that continent set up factories to build this incredible suit of power armor, and some survived the Great Cataclysm. Interestingly enough, there are now more Glitter Boys and variants in South America than in North America (unknown to the CS, Free Quebec and most Northerners).

The GB-7 was a prototype of a new, lighter Glitter Boy with more weapons variety, and ready to be adapted to any number of missions. The armor was form-fitting and could be customized to each wearer. As a result, female pilots were able to pilot *Glitter Girls*, robot suits with a female silhouette. The prototype's blueprints were discovered some 150 years ago, and production of these suits started fifty years ago. GB-7s are still less common than the USA-G10, but they are still fairly popular. Duels between pilots of the two suits are not uncommon, and a lot of pointless arguments as to which suit is better can be heard in almost any bar that caters to mercenaries and other warriors.

One of the main differences between the G10 and the GB-7 is the fact that the latter carries not one but two heavy shoulder-mounted weapons. Although neither is as powerful as the infamous Boom Gun, they provide an interesting balance between energy and kinetic weapons. A heavy laser cannon and a rail gun are the main weapons of the GB-7. The laser has the range but not quite the penetration of the boom gun, and the rail gun has the punch but less range than the G10's weapon. Also, while the laser cannon has effectively an unlimited payload, the gatling gun has less ammunition available than the standard Boom Gun. Under most combat situations, the ability of the pilot to switch back and forth between the two weapon systems allows for a powerful "one-two" combination of sizzling laser energy and the staccato hammering of hundreds of rail gun rounds.

In addition to these main guns, the suit has two side-mounted light lasers that can engage close-in targets. They are also very useful as an anti-missile defense system, and can be readied faster than the heavier weapons. No additional weapon systems were deemed to be necessary, and combat experience has borne that out.

GB-7s can be found in Santiago, Cordoba and the Peruvian city of Arequipa (see the **Empire of the Sun** section). The Santiago army relies on this suit of armor a great deal; over 500 of them are in active service, and several hundred more are in the hands of militia members or mercenaries.

Note: The GB-7 does not have recoil dampening thrusters or anti-sway pylons. Thus, it cannot use the Boom Gun, because the recoil would knock the suit to the ground.

Model Type: AA-GB7

Class: Laser Resistant Armored Military Assault Suit

Crew: One

M.D.C. by Location:

Right Shoulder VF Laser Cannon — 120

Left Shoulder Rail Gun Gatling — 150

Head — 220

Hands (2) — 60 each

Arms (2) — 220 each

Legs (2) — 400 each

Hip Lasers (2) — 70 each

* Main Body — 700

Reinforced Pilot's Compartment — 100

* Depleting the M.D.C. of the main body will shut the robot down completely, rendering it useless. **Note:** Laser weapons do half damage.

Speed

Running: 70 mph (112 kmph) maximum. Note that the act of running does tire out its operator, but at 20% of the usual fatigue rate thanks to the robot exoskeleton.

Leaping: The powerful robot legs can leap up to 10 feet (3.0 m) high or 15 feet lengthwise (4.6 m) from a short running start.

Flying: Not possible.

Statistical Data

Height: 9 feet (2.7 m), or 10 feet (3.0 m) with guns in the firing position.

Width: 4 feet (1.2 m)

Length: 4 feet (1.2 m) including ammo drum

Weight: 1 ton fully loaded

Physical Strength: Equal to a P.S. 30

Cargo: None.

Power System: Nuclear; average energy life is 20 years.

Market Cost: 30 million credits for a new, undamaged GB-7, complete with all weapon systems. Price drops by 10 million if one main weapon system is missing, or for rebuilt ones (reduce M.D.C. by 10% permanently). Good availability in Cordoba, Santiago and the city of Arequipa, poor otherwise.

Weapon Systems

1. Variable Frequency Laser Cannon: This powerful weapon fires a laser beam whose light frequency can be adjusted to blast through reflective and laser resistant armor. The first two blasts do half damage, but the weapon computer automatically adjusts the light frequency to compensate for the laser resistant surface, so all subsequent attacks do full damage, even to Glitter Boys'. The weapon is hooked directly to the

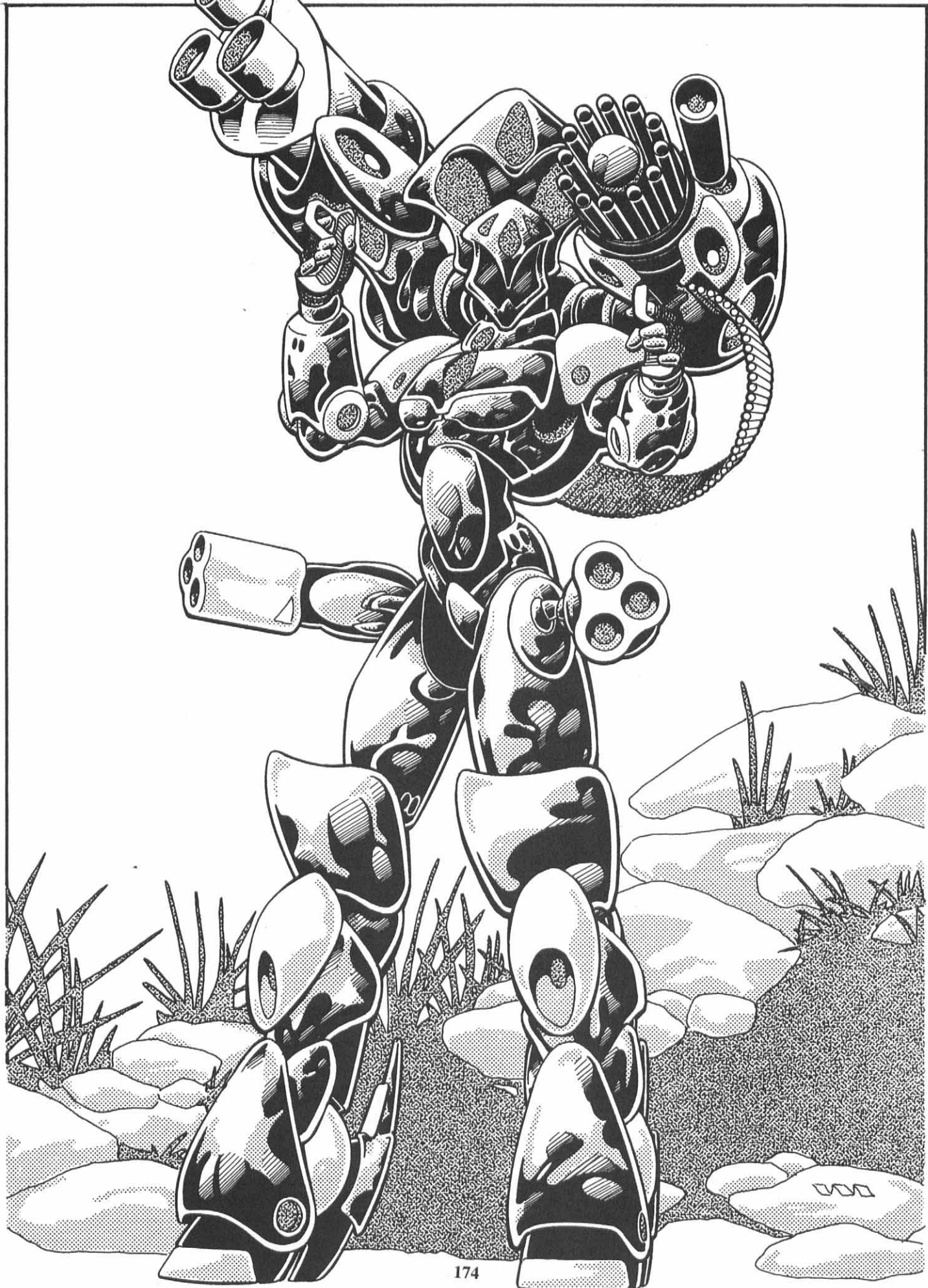

armor's nuclear power supply, eliminating the need of an external power pack.

Note: The wearer cannot fire both shoulder weapons simultaneously without a lot of penalties; such attempts are at -4 to strike with one gun and at -6 with the other (shooter selects which), and this assumes that the attacker was shooting at the same target.

Primary Purpose: Assault

Secondary Purpose: Defense

Mega-Damage: 2D4×10 M.D. per blast

Rate of Fire: Equal to the number of combined hand to hand attacks.

Effective Range: 8000 feet (2440 m).

Payload: Effectively unlimited.

2. Rail Gun Gatling: This weapon system consists of 12 rail guns firing in rotation, providing an incredibly high rate of fire. Bursts of 200 rounds put enough flying metal in the air to match the dreaded Boom Gun. Unlike the real thing, however, the gatling's range is the same as a standard rail gun, making it inferior in long-range engagements. The weapon has an advanced laser-targeting system, mounted just above the gun, that allows the wearer to fire aimed shots with bursts! This ability is partly due to the super-high cyclic rate of the gun, which basically spits out 200 rounds milliseconds before the recoil can be felt by the wearer. The laser aiming system can be used as a weapon in a pinch (range is halved, and damage is 2D4 M.D.).

Primary Purpose: Anti-armor, anti-aircraft.

Secondary Purpose: Defense.

Mega-Damage: A burst is 200 rounds and does 3D6×10 M.D.; can only fire bursts.

Rate of Fire: Equal to the number of hand to hand attacks of the wearer.

Effective Range: 4000 feet (1220 m).

Payload: Belt-fed from drum magazine containing 8000 rounds; that's 40 bursts. An additional drum can be carried, attached to the waist; changing drums counts as two melee actions/attacks.

3. Hip Lasers (2): Two tri-barreled lasers are mounted on mechanical arm mounts on the hips. They can be slaved to the visor of the pilot and can shoot very quickly. If the hip lasers are the first weapon used in a melee round, the Glitter Boy pilot gets a +1 bonus to initiative. The weapons cannot bear on exactly the same target, so double blasts are only possible on huge targets (a cross-section of at least 20 feet/6.1 m). Unlike the laser cannon, these lasers do not have a variable frequency, so they are not as effective against Glitter Boys and other targets with reflective armor.

Primary Purpose: Anti-missile or anti-personnel.

Secondary Purpose: Defense

Mega-Damage: 3D6 M.D. per gun; a double blast (possible only against large targets) inflicts 6D6 M.D.

Rate of Fire: Equal to the combined number of hand to hand attacks of the pilot.

Effective Range: 2000 feet (610 m)

Payload: Effectively unlimited.

4. Hand to Hand Combat: Rather than use a weapon, the pilot can engage in mega-damage hand to hand combat. The following bonuses are in addition to those from Power Armor Combat Training found in the Robot Combat section of the *Rifts RPG*, page 45.

+1 to strike with laser cannon and rail gun gatling.

+1 on initiative

+1 to parry and dodge

+1 to roll with impact.

Mastodon Battle Robot

The Mastodon (officially called the "Hannibal") is a large combat robot inspired by the war elephants of antiquity and by the living mastodons and mammoths that have been Rifted to Earth (including South America) in the last centuries. This military vehicle is used as a shock/assault weapon, and is designed to intimidate enemies or, failing that, to crush them without mercy. This giant robot has the honor of being the second largest walking war machine on the continent, with the Galapagos being the biggest.

The only nation to produce the Mastodon is Cordoba. This powerful nation-state has nearly two hundred of these imposing robots in service. Production only started eight years ago, and Cordoba's engineers predict that they can double the numbers currently in service in as little as two years, should the need arise. The vision of would-be-emperor Borges (see the **Cordoba section**) is to trample his enemies under the weight of these and other mechanical monsters. Even the technologically-advanced Arkhons have learned not to mess with a Mastodon unless absolutely necessary.

The massive robot is laden with heavy armor and weaponry. The "trunk" is designed to act as a close combat weapon, and is tipped with a spiked "morning star" ball that can shatter buildings and hammer through M.D.C. plates with a few flailing blows. Two heavy missile launchers allow the pilot or gunners to engage long-range targets on the ground or the air. For direct fire, a turret on top uses a vehicle version of the infamous "boom gun" used in the Glitter Boy armor! The "tusks" of the Mastodon are laser cannons that shoot devastating double blasts. A short-range particle beam weapon mounted on the belly can be used against masses of infantry troops or light vehicles, and two mini-missile MLRS boxes provides protection against enemy missiles and aircraft, as well as to strike at targets up close.

The ears of the pseudo-elephant hide a new weapon developed by Cordoba researchers, the Death Mirrors. They are two ultra-intense flashing mirrors that can dazzle and blind troops during the daytime, and which flash in subliminal combinations designed to provoke epileptic convulsions which work on 10% of humans; the flashing mirror-like surfaces can produce three different flash combinations, affecting roughly 20-30% of most human (and human mutant) formations. Polarized helmets help against this attack, but do not offer complete protection. This insidious weapon has allowed one Mastodon to take out dozens or even hundreds of opponents.

Despite its firepower, the Mastodon is not invincible. Guerrillas and other enemies have learned that the size and weight of the robot make it vulnerable to old-fashioned "tiger traps" (pits/holes dug into the ground), as well as mines and other weapons designed to produce a "mobility kill." Being such a large target, the Mastodon cannot move fast enough to dodge enemy attacks; its only hope to survive a fight against well-armed

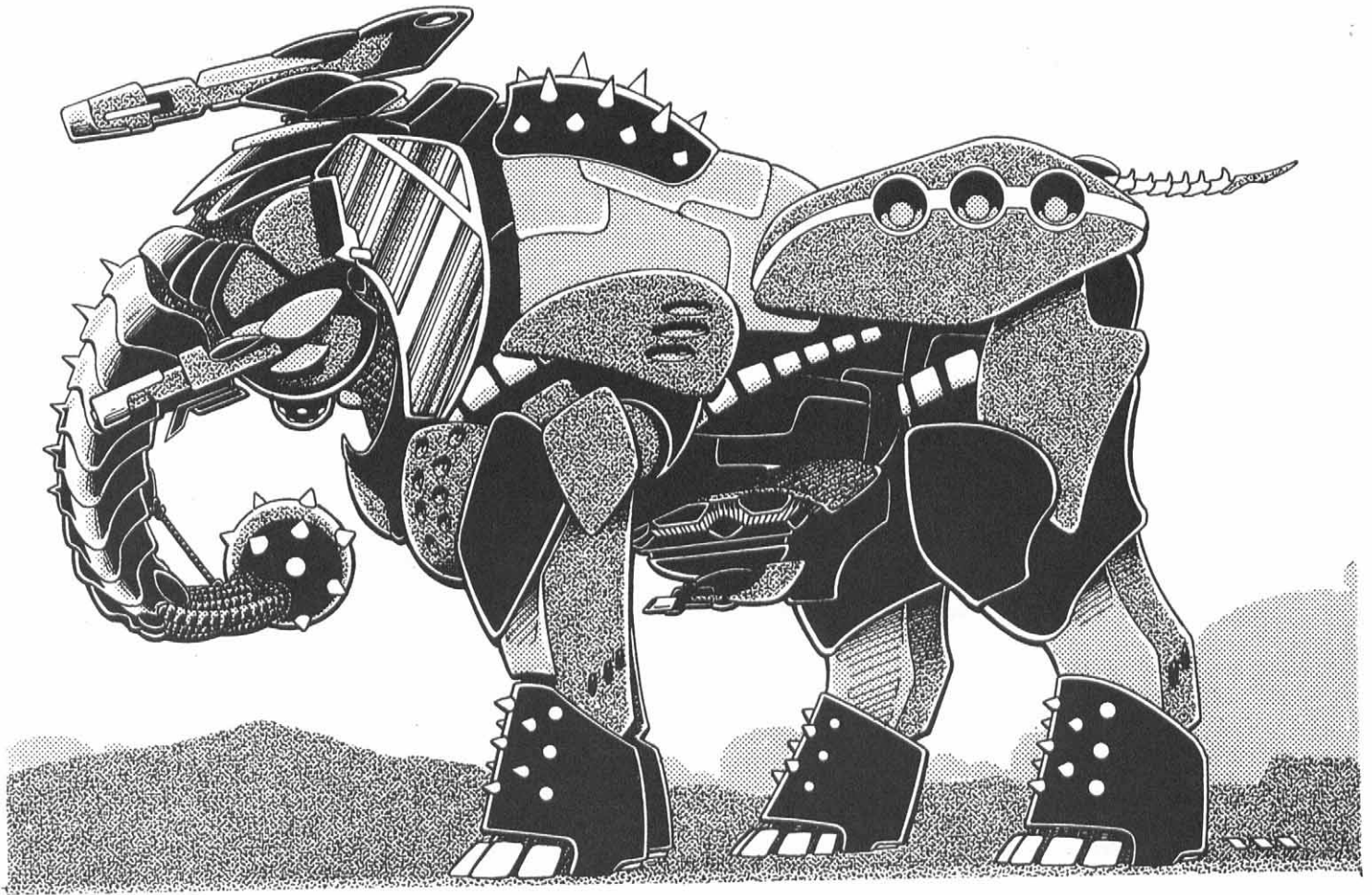

enemies is to overwhelm them through firepower or the use of the Death Mirrors. Most of the time, that is enough.

Model Type: SHAB-10

Class: Super-heavy Assault Robot

Crew: Five; pilot, copilot/gunner, and three gunners; the main gunner is on the Boom Gun turret. Two additional human-sized passengers could be squeezed in if absolutely necessary.

M.D.C. by Location:

Heavy Missile Launchers (2, on rear sides) — 200 each

Boom Gun Turret (top) — 300

Trunk/Flail — 250

Legs (4) — 400 each

Head — 450

* Death Mirrors (2, on sides of head) — 150 each

Laser Tusks (2) — 250 each

Particle Beam Belly Gun — 200

MLRS Mini-Missile Launchers (2, on sides, near the front) — 120 each

** Main Body — 950

* Destroying one Death Mirror only protects people on that side of the Mastodon. Both mirrors must be destroyed before the dazzling flashes stop.

** Depleting the M.D.C. of the main body destroys the robot and shuts down all systems.

Speed

Driving on the ground: 70 mph (112 kmph)

Leaping: Not possible.

Flying: Not possible.

Statistical Data

Height: 35 feet (10.6 m)

Width: 20 feet (6.1 m)

Length: 40 feet (12.2 m)

Weight: 160 tons fully loaded

Physical Strength: Equal to a P.S. 55

Cargo: Minimal storage space for each crew member; about a one foot compartment each, with enough room for a rifle, a handgun, and basic survival equipment.

Power System: Nuclear, average energy life is 10 years.

Market Cost: 200 million credits.

Weapon Systems

1. Long-Range Missile Launchers (2): Two missile launchers are located on the sides of the Mastodon, toward the rear. These missiles give this vehicle the capabilities of an artillery battery.

Primary Purpose: Bombardment

Secondary Purpose: Anti-armor

Mega-Damage: Varies by missile type.

Rate of Fire: One at a time, or in volleys of 2, 4, 8 or 16 missiles per launcher.

Effective Range: Varies with missile type.

Payload: 32 total; 16 per launcher.

2. Death Mirrors (2): The “ears” of the robot are mirrors that flash lights in a subliminal combination designed to trigger epileptic convulsions in humans. The lights somehow trigger impulses in the brain that temporarily shut down motor control. This principle was discovered in a Cordoban medical

lab, and the military promptly applied it. Otherwise, the flashing, blinding lights, makes it very difficult to aim at.

Primary Purpose: Anti-personnel

Secondary Purpose: Non-lethal warfare/crowd control.

Mega-Damage: None. Each person in range has a 25% chance of being affected (roll for each character, or, in a large group, one-fourth will be affected). People affected must roll vs non-lethal poison (16 or higher). If successful, the victim is only stunned for one round (loses initiative and one melee attack). If the save is failed, the victim falls to the ground, convulsing and with no control over his own movements (no attacks or actions are possible). This effect lasts 1D4 minutes. Polarized helmets/goggles give the target a +5 to save versus the attack.

Rate of Fire: Once per melee round.

Effective Range: 500 feet (152 m). All the people in a 100 feet (30.5 m) radius are affected.

Payload: Effectively unlimited.

3. Boom Gun Turret: A turret near the top of the head holds a vehicle version of the infamous "boom gun" used by the Glimmer Boy armor. This is the principal weapon of this massive robot; the recoil of the gun is negligible for this 160-ton vehicle, and it can engage and destroy tanks, flying targets (the turret can rotate 90 degrees up) and enemy robots with equal ease.

Primary Purpose: Anti-armor and anti-aircraft.

Secondary Purpose: Defense

Mega-Damage: 3D6×10 M.D. per shot of 200 flechettes.

Rate of Fire: Equal to the number of hand to hand attacks of the gunner.

Effective Range: 11,000 feet (about two miles/3.2 km)

Payload: 15,000 rounds. (75 blasts).

4. Laser Tusks: Two laser cannons are built into the tusks.

Primary Purpose: Anti-armor

Secondary Purpose: Defense

Mega-Damage: 1D4×10 M.D. per single blast; simultaneous double blast does 2D4×10 M.D. (counts as two melee attacks)

Rate of Fire: Equal to the combined number of hand to hand attacks of the gunner.

Effective Range: 6000 feet (1830 m)

Payload: Effectively unlimited.

5. Particle Beam Belly Gun: This gun is mainly used to fire at targets that get too close to the robot for the main weapon systems to engage effectively (within 50 feet/15.2 m). The gun can also rotate 360 degrees and fire at enemies behind the robot.

Primary Purpose: Anti-personnel

Secondary Purpose: Defense

Mega-Damage: 1D4×10 M.D. per blast.

Rate of Fire: Equal to the combined number of hand to hand attacks of the gunner.

Effective Range: 1000 feet (305 m)

Payload: Effectively unlimited.

6. MLRS (Multiple launch rocket system) Mini-Missile

Launchers (2): The front sides of the elephant have two long columns of mini-missiles, staggered in two vertical rows on each side. Massive salvos from these launchers are usually saved for large enemy formations or large vehicles (like an enemy Mastodon). Smaller volleys are sometimes used to destroy enemy missiles, aircraft and infantry.

Primary Purpose: Anti-armor and anti-personnel.

Secondary Purpose: Defense

Mega-Damage: Varies with missile type.

Rate of Fire: One at a time, or in volleys of two, four, eight, sixteen or 32 mini-missiles per launcher.

Effective Range: About one mile (1.6 km).

Payload: 32 total; 16 mini-missiles per launcher.

7. Morningstar Trunk: The trunk of the Mastodon has a large, spiked mace on its tip. The morningstar is energized like a vibro-blade. In close combat, it can swing this weapon with devastating effects.

Primary Purpose: Anti-armor

Mega-Damage: 1D6×10 M.D. per energized strike; when not energized, the morningstar still hits like a wrecking ball and does 4D6+6 M.D.

8. Hand to Hand Combat: Rather than use a weapon, the pilot can engage in mega-damage hand to hand combat:

Robot Combat Bonuses:

+1 attack per melee at levels one, two, six, and eleven (main gunner and pilot only; all other gunners use their normal number of hand to hand attacks).

+2 to parry.

+2 to pull punch.

+2 to strike and parry with the trunk.

-2 to dodge (too large and slow to dodge).

Other Damage:

Head butt — 2D4 M.D.

Stomp — 3D4 M.D.; effective only against small objects, 12 feet (3.6 m) or smaller.

Full Speed Charge/Ram — 1D4×10 M.D. (counts as two melee attacks).

Galapagos Submersible Robot

The largest and most powerful robot design in South America is fashioned after the giant turtles from the Galapagos island. This behemoth, which dwarves the Mastodon combat robot (and the Coalition Death's Head Transport), is used for both military and scientific purposes, although the former is far more common. The result of very ambitious applications of pre-Rifts technology, this vehicle is capable of traveling on the ground, on the surface of water, underwater, and even has limited flight capabilities. Added to its immense firepower and armor, these qualities make it the foremost combat vehicle of its class. Galapagos robots are used by the nations of Cordoba and Santiago; the blueprints and production facilities are evenly split among the two nations since a treaty led to the sharing of some pre-Rifts technology. A few units have been sold to or stolen by other nations and kingdoms (the Achilles Republic has gotten its hands on half a dozen of these powerful vehicles, much to the chagrin of Cordoba).

The Galapagos robots are one of the main tools of defense against the *Larhold raiders* and seaborne pirates and slavers. The multipurpose vehicle acts as a heavy tank, a troop carrier, an attack ship, and even a flying transport/attack ship. A typical Cordoban LRDC (Long-Range Defense Company) includes a Galapagos robot and its complement of troops, half a dozen Puma tanks and sometimes a combat wing of four attack jets. On rare occasions, a pair of Mastodon Battle Robots will accom-

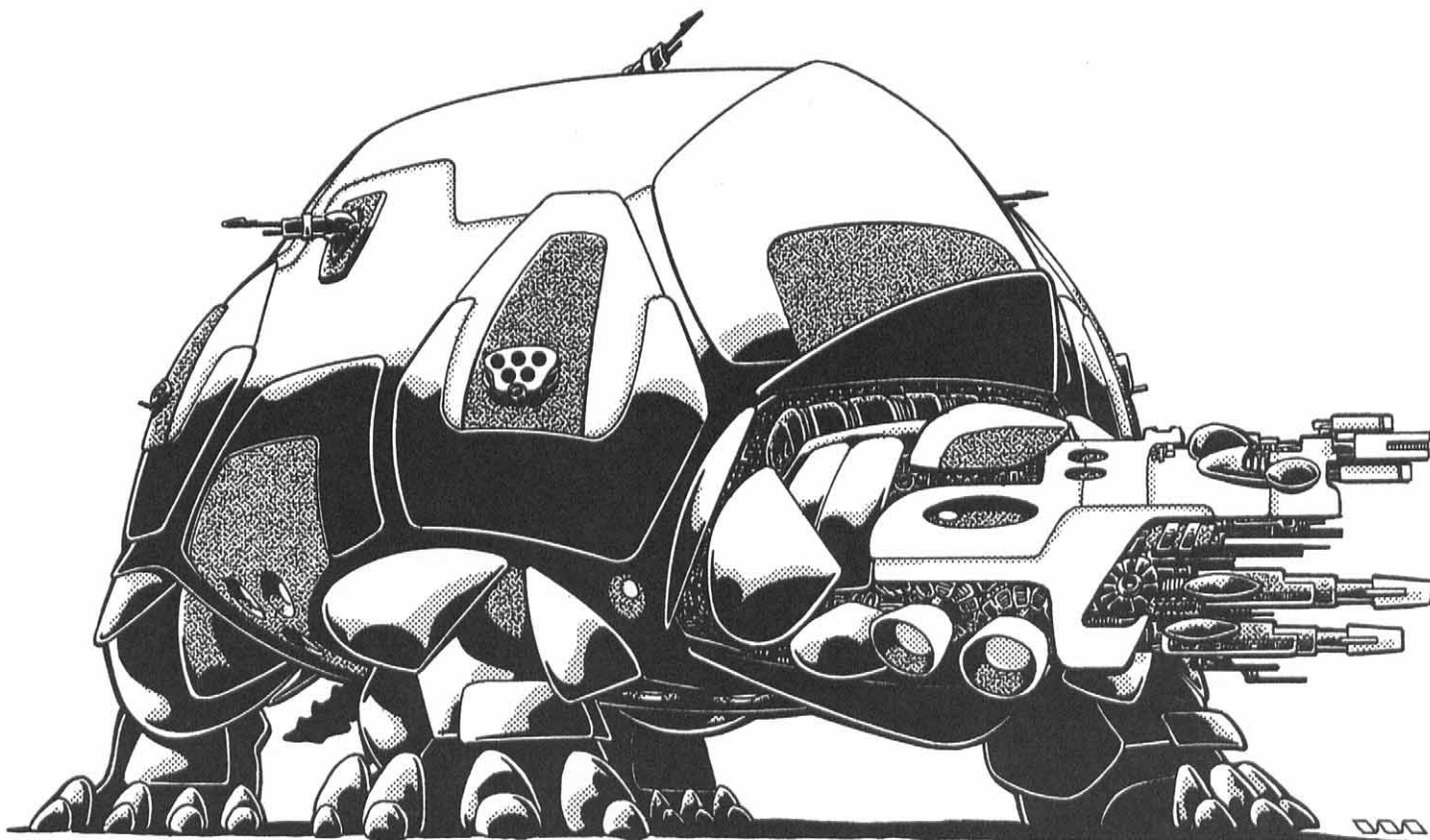

pany a defense company. Using more than two Galapagos robots for the same mission is unheard of except during major military operations. One of the most ominous signs of activity from the Republic of Cordoba is the creation of combat groups led by as many as twelve of these fearsome machines, backed up by twice that number of Mastodon battle 'bots and/or many times more tanks, power armor, and other vehicles.

The basic design of the Galapagos is turtle-like, with a heavily armored carapace that covers both the top and bottom of the vehicle. The "head" is a giant turret with no less than four weapon systems, including two heavy laser cannons, a quad-rail gun used against aircraft, and two sets of missile launchers. Scientific versions used for exploration only have two weapon systems (the particle beam weapon and the lighter missile launchers). Both the head/turret and the four massive legs of the turtle can be retracted inside the armored carapace; the legs are typically retracted during flight or underwater. The head is typically half-retracted, allowing the guns to fire only at targets in front of the vehicle. The neck can be extended as needed to allow different angles of attack; the head can be completely retracted into the shell, protecting it from any attack, but that is usually done if it's taken a lot of damage or while flying at maximum speed. Three other turrets, armed with ion cannons, are placed in strategic portions of the shell (one on the top and two on the sides), and an additional four missile/laser batteries are also distributed around the shell. This latter system can be operated by individual gunners, or can be controlled by a battle computer that fires at pre-selected targets or acts as a missile defense system.

The main drawbacks of the robot are its size and its cost. The tremendous size and weight of the robot makes it unsuitable for a lot of terrains; in mud or soft earth it risks becoming mired, although the leg traction system is incredibly strong and can drag

the robot through a swamp if necessary (but at only 25% maximum speed). The flight system is only safe for short distances, less than an hour's travel every three hours or so, and the vehicle's large size makes it a tempting and easy target. Most enemies concentrate their fire on the giant robot and pay little attention to any other units (which can be made to work in one's favor).

The cost to produce the robot is so high that only the wealthiest (and thus, the biggest) governments can afford it. Most small kingdoms content themselves with owning one of these monsters, and even Cordoba and Santiago have less than a hundred each (latest figures report that Cordoba has eighty-nine functional Galapagos robots, and Santiago has only sixty-three). A Larhold tribe managed to capture one of these robots, and it is now the "flagship" of the entire war band (the vehicle was permanently damaged, however; reduce its M.D.C. by 20%).

Model Type: GATV-5

Class: Sea-Air-Land Ultra-heavy Combat Robot

Crew: 14; commander, pilot, navigator/copilot, communications/sensors officer, 2 engineers and 8 gunners. The robot can be operated with a skeleton crew of 4-6, but most weapon systems must be left in the hands of the automatic fire systems.

Troop Capacity: 3 Hussar APCs and their 12 troops each, 8 Toro Power Armor, 4 Glitter Boys of either make, and 80 infantry soldiers. The APCs can be replaced by 20 troopers without vehicles, or up to seven Hussars can be carried for a total of 84 mechanized soldiers plus the troopers in power armor.

M.D.C. by Location:

Head/Main Turret — 500

Heavy Laser Cannon (2; front where the eyes would be) — 180 each

Quad Rail Gun (1; lower front of the turret) — 200
Medium-Range Missile Launchers (2; on sides of turret) — 180 each
* Neck — 285
Ion Gun Turrets (3) — 250 each
Missile/Laser Batteries (4) — 150 each
*** Legs (4) — 500 each
Reinforced Pilot's Compartment — 200
** Main Body — 1,800

* Destroying the neck separates the head/main turret from the body. Note that the neck can only be targeted if extended (most of the time, the turret is fired while retracted), and even then it requires a called shot.

** Depleting the M.D.C. of the main body destroys the vehicle, rendering it useless.

*** Legs can be only targeted if they aren't retracted into the body.

Speed

Driving on the ground: 50 mph (80.4 kmph)

Flying: 200 mph (320 kmph) or 300 mph (480 kmph) with both head and legs completely retracted.

Underwater: 20 mph (32 kmph/17.2 knots) dived, or 25 mph (40 kmph) on the water's surface.

Range: Theoretically unlimited (years, given the nuclear power plant). Flying can only be sustained for about an hour safely; a cooling off period of 2-3 hours is advised afterwards, to prevent the engines from overheating and overloading. Exceeding this margin has a 5% chance (raised by 1% for every 5 minutes after the first hour of flight) of burning out the flight systems, requiring massive overhauling and repairs (1D4+2 weeks, and 4D6 million credits' worth).

Statistical Data

Height: 70 feet (21.3 m)

Width: 120 feet (36.5 m)

Length: 250 feet (76.5 m)

Weight: 1500 tons fully loaded

Physical Strength: Equal to a P.S. 60

Cargo: Minimal storage, not counting the troop capacity; an additional 100 tons of cargo can be stored, not counting ammunition.

Power System: Nuclear; average energy life is 10 years.

Market Cost: Not for sale to individuals. Cost for the governments of Cordoba and Santiago is approximately 550 million credits.

Weapon Systems

1. Laser Cannons (2): Two heavy laser cannons are on the front of the turret/head. They are meant to fire simultaneous blasts at the enemy.

Primary Purpose: Anti-armor

Secondary Purpose: Defense

Mega-Damage: 2D4×10 M.D. or 4D4×10 M.D. per simultaneous double blast (each counts as one attack per melee).

Rate of Fire: Equal to the number of hand to hand attacks of the gunner.

Effective Range: 6000 feet (1830 m)

Payload: Effectively unlimited.

2. Quad Rail Gun: This weapon consists of four rail gun barrels firing simultaneously, raising the rate of fire of each burst by a large margin. The gun can engage enemy aircraft or infantry, or it can even engage and destroy armored vehicles.

Primary Purpose: Anti-aircraft and anti-personnel.

Secondary Purpose: Defense

Mega-Damage: A burst is 120 rounds and inflicts 2D4×10 M.D. Can only fire bursts.

Rate of Fire: Equal to the number of hand to hand attacks of the gunner.

Effective Range: 3000 feet (914 m)

Payload: 24,000 rounds, that's 200 bursts.

3. Medium-Range Missile Launchers (2): The sides of the robotic head have two missile launch tubes. The launchers can be reloaded from an automatic magazine, but only when the head is partially retracted into the shell. A common sight in combat is the turtle stretching its neck to reach enemy aircraft, firing a volley and then retracting the neck to reload.

Primary Purpose: Anti-aircraft and bombardment.

Secondary Purpose: Defense

Mega-Damage: Varies by missile type.

Rate of Fire: One at a time, or in volleys of two, four or eight.

Effective Range: 40 to 80 miles (64 to 128 km)

Payload: 8; each launcher holds 4 medium-range missiles. An additional 64 missiles are stored in the main body; to reload, the turret must be partially retracted (takes one melee attack; can only fire at front targets) and there's a wait while the auto-loading system replaces the missiles (takes one melee round).

4. Ion Gun Turrets (3): These guns give the robot a 360 degree arc of fire; targets can be engaged anywhere around the robot. Theoretically, these guns create a "bubble" of 4000 feet (1220 m) in every direction around the robot (except underground), where nothing can live without the consent of the gunners. This is called the "death zone."

Primary Purpose: Anti-armor and anti-personnel.

Secondary Purpose: Defense

Mega-Damage: 1D6×10 M.D. per blast.

Rate of Fire: Equal to the number of hand to hand attacks of the gunner.

Effective Range: 4000 feet (1220 m)

Payload: Effectively unlimited

5. Missile/Laser Batteries (4): Each mini-turret has 8 mini-missiles and a medium laser.

Primary Purpose: Anti-aircraft and anti-personnel.

Secondary Purpose: Defense

Mega-Damage: Laser: 4D6+6 M.D. Missile: By type.

Rate of Fire: Laser: Equal to the number of hand to hand attacks of the gunner. Missiles: One at a time, or in volleys of two, four or eight per launcher.

Effective Range: Laser: 4000 feet (1220 m). Missiles: about a mile.

Payload: Laser: Unlimited. Missiles: 32 total; 8 per launcher.

6. Hand to Hand Combat: Rather than use a weapon, the pilot can engage in mega-damage hand to hand combat.

Robot Combat Bonuses:

+1 attack per melee at levels one, three, six, and eleven (main gunner and pilot only; all other gunners use their normal number of hand to hand attacks).

No dodge.

+2 to strike.

Other Damage:

Head butt — 2D6 M.D.

Stomp does 1D4×10 M.D. to targets smaller than 20 feet (6.1 m) tall.

Puma-class Medium Battle Tank (Cordoba/Santiago)

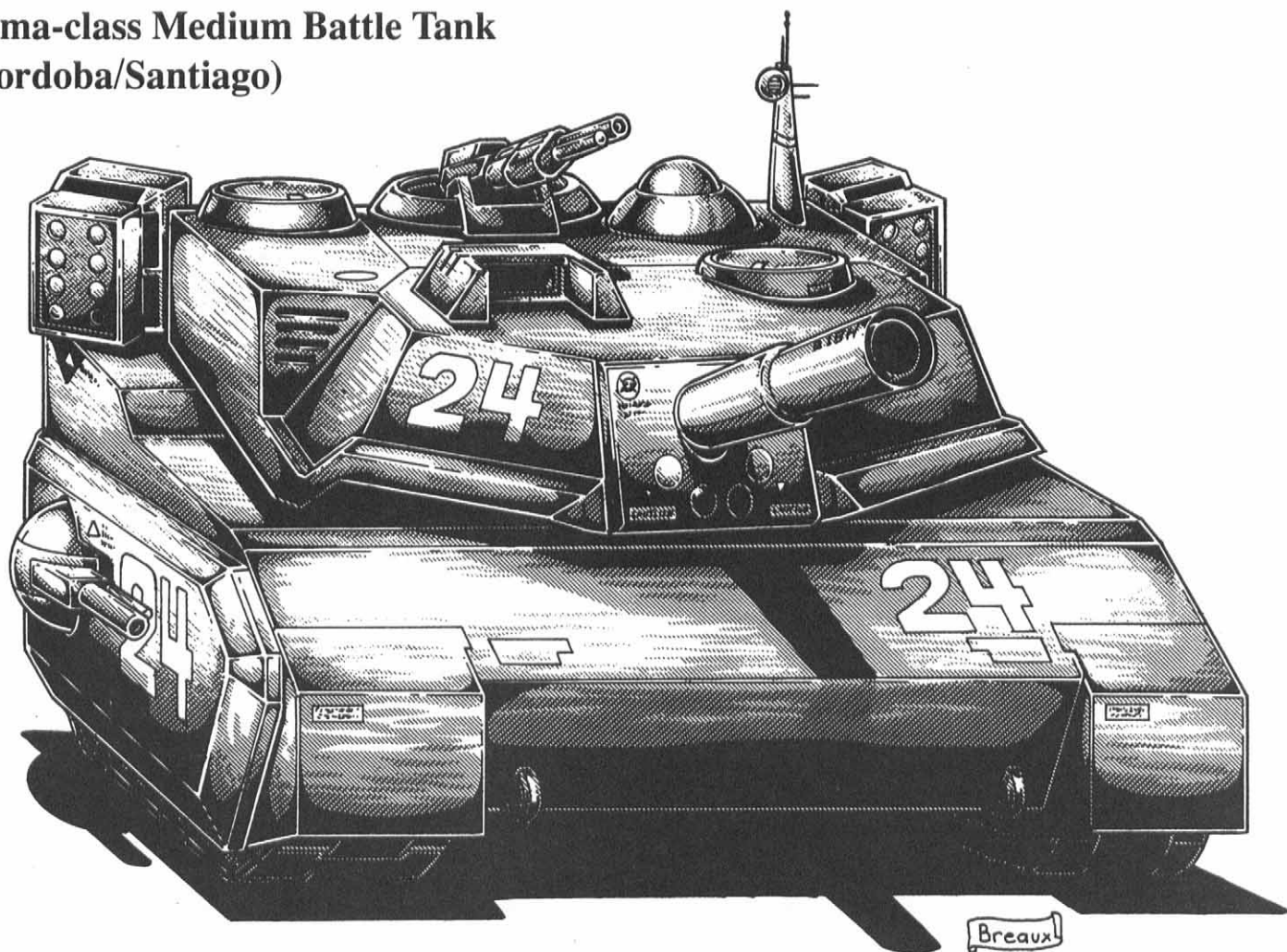

The Puma is a highly mobile and well-armed combat tank, based on pre-Rifts technologies. This combat vehicle can fight robots, monsters and all kinds of threats and is still cheaper to produce than a conventional robot. The tank relies on a cannon/missile launcher system built into a turret. The main gun fires conventional rounds, and a missile launcher beneath it can ripple-launch devastating volleys. Other weapon systems include a pre-Rifts rediscovery, the Strobe Laser Array System (SLAS); a multi-faceted laser that can strike dozens of targets simultaneously and is an excellent anti-missile defense. Rail gun turrets and secondary mini-missile launchers complete the firepower package. The tank requires a crew of four for maximum efficiency; a driver, two gunners and a commander/gunner, although it can be operated by as few as two crew members. The tank can be powered by either a combustion or electrical engine, or a nuclear power plant; the latter is far more expensive and only special units are outfitted with such tanks.

Ironically, both this tank and its companion vehicle, the Husar APC, were the result of a joint weapons research project sponsored by both Cordoba and Santiago. Now the two nations are on the brink of war, and they are equipped with the same combat vehicles.

Model Type: PT-34

Class: Medium Tank

Crew: Four

M.D.C. by Location:

** Turret — 350

Main Gun (In Turret) — 200

Medium-Range Missile Launcher (In turret, below main gun) — 100

Rail Gun Cupola (on top of Turret) — 100

Rail Gun Mini-Turrets (2, on sides) — 70 each

Mini-Missile Launchers (2, on sides) — 80 each

* SLAS laser globe (in pop-up compartment in turret) — 60

*** Tracks/Treads (2) — 300 each

**** Main Body — 550

* The SLAS can only be targeted when deployed (most of the time it is hidden inside the turret). Even when deployed, it is a very small target, requiring a called shot at -4 to strike.

** Depleting the M.D.C. of the turret tears it off the vehicle, rendering all weapons in it useless. Targeting the turret requires a called shot at no further penalty

*** Destroying the treads immobilizes the tank. Replacing the treads (the tank carries 4 spares) takes 1D6x10 minutes for a trained crew (twice as long for the inexperienced). Targeting the treads requires a called shot at -2 to strike.

**** Depleting the M.D.C. of the main body destroys the vehicle, rendering it useless.

Speed

Driving on the ground: 100 mph (160 kmph) maximum speed on level terrain. Over broken terrain and off-road, maximum safe speed is 60 mph (96 kmph). Exceeding the safe speed has a cumulative 10% chance of "jumping" a tread every hour (10% on the first hour, 20% on the second hour, and so on).

Flying: Not possible.

Range: 500 miles (800 km) with a combustion or electrical engine.

Statistical Data

Height: 9 feet (2.7 m); 10 feet (3.0 m) counting the rail gun cupola.

Width: 8 feet (2.4 m)

Length: 12 feet (3.65 m)

Weight: 30 tons fully loaded.

Cargo: Small compartment has enough room for personal effects and one hand weapon (pistol or sub-machinegun-sized). Weapons locker has room for four rifles, 20 E-Clips and 20 grenades.

Power System: Combustion, electrical or nuclear.

Market Cost: 1.5 million credits for a tank with combustion or electrical engine. 10 million credits for one with a nuclear engine. Sold only to reputable military organizations. Captured or stolen tanks (typically with 20% less M.D.C. and missing the SLAS and one other weapon system) can be had for about half price.

Weapon Systems

1. Main Gun: This is a 120mm cannon firing either high-explosive or armor-piercing, discarding-sabot (APDS) solid shot. The gun can be fired as often as twice per melee (the auto-loading magazine takes 6 seconds to cycle a new round in).

Primary Purpose: Anti-tank

Secondary Purpose: Anti-personnel and assault.

Mega-Damage: High-Explosive Rounds: 1D6×10 M.D. to a 30 foot (9.1 m) blast radius. APDS Rounds: 2D4×10 M.D. (no blast radius).

Rate of Fire: Up to twice per melee round. Each shot counts as one melee attack/action.

Effective Range: 4000 feet (1220 m).

Payload: 90 rounds in two 45 round internal compartments. Typically, one compartment is loaded with high-explosive and the other has armor-piercing rounds.

2. Medium-Range Missile Launcher: Four launch "doors" are aligned in two rows under the main gun. After the four compartments are emptied, the launchers are reloaded from an internal magazine, allowing for multiple launches.

Primary Purpose: Anti-armor and medium-range bombardment.

Secondary Purpose: Anti-aircraft

Mega-Damage: Varies with missile type.

Rate of Fire: One at a time, or in volleys of two or four missiles. After the launchers are empty, four more missiles can be cycled in one melee round (so the launchers can fire every other melee round).

Effective Range: 40 to 80 miles (64 to 128 km)

Payload: 24 missiles total; 4 in the launcher, 20 in an internal compartment.

3. SLAS: This device was a cutting-edge development of pre-Rifts weapon technology. Inspired by early SDI (Strategic Defense Initiative) killer satellite systems, the SLAS consists of a multi-faceted laser system that could strike up to ten different targets simultaneously. The main difficulty in reinventing the SLAS was the need for sophisticated computer targeting systems: the SLAS works best as an automated defense system. At first sight, the SLAS looks like a mirror ball from a 20th Century disco, attached to a slim shaft. When activated, a hidden compartment slides to one side and the ball rises 3 feet (0.9 m) above the turret. From there, the lasers can

engage incoming missiles, or the gunner can override the automated system and engage a target with as many as five lasers simultaneously. The SLAS automated system has a base +3 to strike. It is great to shoot down missiles and to mow down lightly armored infantrymen who try to close in on the vehicle.

The weapon system is not perfect, however. For one, it needs to be mounted on a relatively stable platform such as a tank. A robot is too unbalanced for the SLAS to be used safely; the lasers might end up shooting the robot in the arms, feet or head! Also, the lasers are relatively short-ranged and useful mostly as a defensive system. Finally, the automated targeting system can be overloaded by multiple targets.

Primary Purpose: Defense/Anti-missile.

Secondary Purpose: Anti-personnel and anti-vehicle.

Mega-Damage: Each individual laser beam does 2D6 M.D. Up to five beams can be fired at an individual target, inflicting a maximum of 1D6×10 M.D. Multiple beams reduce the amount of attacks the laser has.

Rate of Fire: Up to ten attacks per melee if the automated system is used. A gunner can override and fire the laser individually or simultaneously; any such attack counts as one melee attack from the gunner, but the automated system cannot be used in that round. The laser can shoot down up to five missiles in a volley; if a volley has more than five missiles, roll percentile dice: 01-60%: the laser neutralizes five missiles. 61-00%: the targeting system freezes and does not fire or only hits one missile and the rest of the volley continues!

Effective Range: 1000 feet (305 m)

Payload: Effectively unlimited.

4. Rail Gun Cupola: This is the back-up weapon of the turret gunner or the tank commander, and is also used to engage enemy infantry.

Primary Purpose: Anti-personnel

Secondary Purpose: Defense

Mega-Damage: A burst is 60 rounds and does 1D4×10 M.D. Can only fire bursts.

Rate of Fire: Equal to the number of hand to hand attacks per melee.

Effective Range: 2000 feet (610 m)

Payload: 9000 rounds (that's 150 bursts).

5. Rail Gun Mini-Turrets (2): These side-mounted guns can be used by the driver or the secondary gunner.

Primary Purpose: Anti-personnel

Secondary Purpose: Defense

Mega-Damage: A burst is 60 rounds and does 1D4×10 M.D. Can only fire bursts.

Rate of Fire: Equal to the number of hand to hand attacks per melee.

Effective Range: 2000 feet (610 m)

Payload: 3000 rounds (that's 50 bursts).

6. Mini-Missile Launchers (2): Two launchers are mounted on the sides, near the back, where they can engage both air and ground targets.

Primary Purpose: Anti-aircraft and anti-armor.

Mega-Damage: Varies with missile type.

Rate of Fire: One at a time, or in volleys of two, four or eight per launcher; the two launchers cannot engage the same target.

Effective Range: About one mile (1.6 km).

Payload: 16 total; 8 per launcher.



Hussar APC (Cordoba and Santiago)

The Hussar was part of the same collaboration that produced the Puma Medium Battle Tank. This armored personnel carrier was built to keep up with the Puma and to carry a small squad of 8 soldiers. The vehicle is not heavily armed; its turret has a rail gun and a mini-missile launcher on each side. It is fast and its firepower is not in its weapon systems but with the soldiers it carries. A typical Cordoba mechanized squad has 2-4 Puma Tanks supported by 2-6 Hussars. Santiago organizes its vehicles differently, with tank squads of 4 Pumas, supported by a separate squads 4-6 Hussars. In the near future, the comparative benefits of the two formations may be put to the test in the field of battle.

Model Type: HTT-11

Class: Armored Personnel Carrier

Crew: Two; a driver and a gunner.

Troop Capacity: 8 soldiers in body armor or 6 troopers in power armor.

M.D.C. by Location:

* Turret — 120

Rail Gun in Turret — 100

Mini-Missile Launchers (2, on turret sides) — 60 each

** Tank Treads — 120 each

*** Main Body — 280

* Depleting the M.D.C. of the turret tears it off the vehicle, rendering all weapons in it useless. Targeting the turret requires a called shot at no further penalty.

** Destroying the treads immobilizes the tank. Replacing the treads (the tank carries 4 spares) takes 1D6 x 10 minutes

for a trained crew (twice as long for the inexperienced). Targeting the treads requires a called shot at -2 to strike.

*** Depleting the M.D.C. of the main body destroys the vehicle, rendering it useless.

Speed

Driving on the ground: 100 mph (160 kmph) maximum speed on level terrain. Over broken terrain and off-road, maximum safe speed is 60 mph (96 kmph). Exceeding the safe speed has a cumulative 10% chance of "jumping" a tread every hour (10% on the first hour, 20% on the second hour, and so on).

Flying: Not possible.

Range: 550 miles (880 km) with a combustion or electrical engine.

Statistical Data

Height: 8 feet (2.4 m)

Width: 8 feet (2.4 m)

Length: 10 feet (3.0 m)

Weight: 15 tons fully loaded.

Cargo: Small compartment has enough room for personal effects and one hand weapon (pistol or sub-machinegun-sized). Weapons locker has room for eight rifles, three missile launchers, 60 E-Clips and 40 grenades.

Power System: Combustion, electrical or nuclear.

Market Cost: 1 million credits for a tank with combustion or electrical engine. 10 million credits for one with a nuclear engine. Sold only to reputable military organizations. Captured/stolen tanks (typically with 20% less M.D.C. and missing one other weapon system) can be had for half price.

Weapon Systems

1. Rail Gun: A rail gun with a high cyclic rate is mounted on the turret, and acts as the APC's main gun.

Primary Purpose: Anti-armor

Secondary Purpose: Defense

Mega-Damage: A burst is 80 rounds and inflicts 1D6×10+10 M.D. Can only fire bursts.

Rate of Fire: Equal to the number of hand to hand attacks per melee.

Effective Range: 2000 feet (610 m)

Payload: 8,000 rounds; that's 100 bursts.

2. Missile Launchers (2): These mini-missile launchers are on each side of the rail gun, and are used to give the APC a long-distance weapon.

Primary Purpose: Anti-aircraft and anti-personnel.

Secondary Purpose: Defense

Mega-Damage: Varies with missile type.

Rate of Fire: One at a time, or in volleys of two, four, six, eight or sixteen missiles.

Effective Range: About one mile (1.6 km).

Payload: 16 total; eight per launcher.

The Larhold Barbarians

Population Breakdown: 4.6 million total (60% Larhold, 5% human renegades, 35% diverse other races, especially giants, ogres, brodkil, etc.). A Larhold tribe typically has between 1,000 and 100,000 members; the larger tribes are typically divided into 5-20 smaller bands.

The Larhold are a nomadic race with great magical powers; they have been compared to the Horune (see *Rifts Underseas*) in terms of their power, savagery, and capabilities. While the Horune are pirates and operate mostly in the seas and coastlines of the world, the Larhold are land-bound nomads who travel with their herds of cattle and raid the "dirt-grubbers," as they contemptuously call farmers. Several hundred of these beings arrived through the Rifts opened during the Great Cataclysm, including several shamans and priests. These magicians, in turn, opened more Rifts to allow more of their tribesmen to arrive. While many beings considered the monster-plagued lands of Rifts Earth to be a place to avoid, the Larhold saw it as a land of opportunity, a place where the ruins of an entire civilization lay ready to be plundered.

Over the centuries, the barbarians have grown in numbers; as of 100 P.A., their population was in the millions, and still growing, despite several attempts by other cultures to wipe them out. For the time being, they have been isolated to the plains of South America. To go anywhere else, they have to go through the Silver River Republics, the Empire of the Sun, or the Arkhons' holdings. With their increasing population, they may be able to do so in a few years, especially if the Silver River Republics continue bickering among themselves.

History

The Larhold are transdimensional nomads and raiders. Early in their history, before they had developed any technology beyond metalworking, their culture discovered advanced magic. Some dimensional sages believe this knowledge was the "gift" of some alien intelligence, demon, or a god of darkness. The fact that most Larhold worship such entities points in that direction as the likely source of their power. In any case, their newfound magical abilities made them extremely powerful, especially their mastery over the *Blue Flame*, a form of energy largely unknown in the Megaverse. They also learned how to open dimensional portals, and soon entire tribes abandoned their prairie-covered planet and ventured onto other worlds.

Many, perhaps most, Larhold perished as they encountered advanced cultures who quickly wiped out the alien barbarians. Some of the enemies the Larhold ran into during their millennia of travel included the Splugorth, who often enslaved them Naruni Enterprises, which sometimes hires them as mercenaries (and more often sold weapons to their enemies; and on a few occasions did both!), gods of light and darkness, who embroiled them in their age-old conflicts and many others. Whenever the Larhold did not encounter overwhelming odds, they thrived, sacking and destroying cities; enslaving or murdering the inhabitants, and soon reducing entire nations and planets to barren wastelands. The nomads, traveling on their monster-drawn wagons, moved quickly and rarely stopped in one place longer than was necessary to devastate it.

During their travels, many Larhold learned to worship some of the most evil and savage deities and alien intelligences in the Megaverse. Many are followers of the Gods of Darkness, including Set, Ahriman, and others. A few worship the Horsemen of the Apocalypse (see *Rifts World Book Four: Africa*) and still others sacrifice victims to alien intelligences like the dreaded Old Ones. In return, some tribes have been granted supernatural powers. Witches (see *Rifts Conversion Book One*) are common among many tribes; they have almost as much respect and status as the *shamans of the Blue Flame*. With their magic and their connections to the forces of darkness, some Larhold managed to survive the dangers and pitfalls of dimensional raiding.

As they came into contact with technological civilizations, the Larhold acquired a taste for high-tech weapons and equipment. Soon jeeps, trucks and motorcycles traveled side by side with animal-drawn vehicles. Soon for every Larhold there were one to two slaves of diverse races. These slaves were valued for their skills; they included mechanics, weaponsmiths, technicians, doctors and engineers among their numbers. Drawing on the knowledge of those slaves, the Larhold were able to field a powerful army. Eventually, the larger Larhold tribes were a force to be reckoned with.

As their slaves multiplied and had children, a number of non-Larhold soon became part of the tribe. These were the spawn of slaves who proved to be tough and ruthless enough to win their freedom and were welcomed into the ranks of the nomadic tribes. Among the "new Larhold" were beings like the brodkil,

gargoyles, mutants, denizens of Wormwood, ogres, and giants. Humans, as one of the most numerous species in the Megaverse, eventually had a presence even among these barbarians. Human "Larhold" became incredibly vicious, cunning fighters, using their skills and trickery to best beings with supernatural strength. The leaders of the nomadic tribes, however, continue to be "true" Larhold warriors.

On many worlds, the mention of the name "Larhold" is enough to make the natives nervous. The more ruthless and evil transdimensional cultures, like the Splugorth, have placed a 2,000-10,000 credit bounty on the horns of a Larhold. Many bounty hunters have met their demise trying to claim the barbaric bounty. Other civilizations have used every resource at their disposal to destroy or even exterminate the barbarians. Although the Larhold have been killed by the millions, many more still remain, the scourge of ten thousand worlds.

The Larhold arrived on Earth in several places. Small bands were accidentally Rifted to North America, Europe and Asia. These relatively small tribes never had enough numbers to make a difference. A much larger contingent arrived in the Andes mountains and threatened the cities of the Nazca (see the **Empire of the Sun** section). The combined forces of the Empire of the Sun and the Nazca Line Makers were enough to push the Larhold out of their territory. The barbarians, who have little liking for mountains anyway, settled in the plains to the east.

The Larhold of South America have changed their tactics. Although they still roam about and rarely stay anywhere for periods longer than a month, these nomads no longer travel throughout the Megaverse. Instead, each tribe or sub-tribe has a defined "range" which they travel through in a migratory route. Along the way, they plunder all neighboring lands and rival tribes; war between two Larhold tribes is fairly common, and just as vicious as when fighting non-Larhold. A few tribes have even allowed some towns and cities to survive with one condition: whenever the Larhold arrive in town, a huge tax is collected from that city, ranging in anything from gold and weapons to slaves and services. In return, the Larhold do not destroy the community and let the inhabitants rule themselves as they see fit, so long as they do not interfere with the nomads.

The growth of human and D-Bee settlements in the area have affected the Larhold. Large tribes still cross all national borders with relative impunity; the continent is so sparsely populated (most "countries" have less total population than a pre-Rifts city) that war bands with over a thousand warriors can still get past patrols and border crossings, free to raid further inland. Still, pressure from such nations as Cordoba, New Babylon and Achilles have forced the Larhold south. While their tribes roam as far north as the Lesser Amazon, the greatest concentration of the barbarians is in the southwestern tip of the continent, where they are in constant conflict with the **Southern Federation**. This concentration is potentially explosive; as more and more Larhold start competing for limited space and resources, several or even all the tribes could be unified under a single, powerful ruler. Such a confederation might have enough numbers to overwhelm the more civilized nations to the north.

Government and Society

Most Larhold tribes have two leaders: the chieftain and the shaman. Chieftains are war leaders, respected for their prowess, cruelty or luck. The eldest son of a chieftain succeeds his father when he becomes too old or feeble to rule, or when he dies. However, if the new chief is too young or too inept to control his people, another relative (often an older uncle or cousin) will challenge him to a duel, kill him, and take his place. Even among the ruling classes, violence and the rule of the strongest are a way of life.

Among most tribes, the shaman has almost as much authority as the chieftain. In others, the shaman is the ruler in all but name, and in a few instances, a shaman has also become a chieftain, assuming both roles at the same time. These shaman-kings are legendary figures among the Larhold. They have often unified a number of tribes and led them in savage campaigns against whole worlds. For the most part, however, shamans are concerned with the magical and supernatural aspects of Larhold life. They and their assistants (some shamans have as many as 100+ lesser shamans at their command) help warriors with their spells, or use divination magic to learn what the best strategy will be in a future battle. They also open the Rifts through which the Larhold travel to other worlds, and perform ceremonies and rituals to raise the morale of the tribe. Unlike chieftains, who are for the most part, male, shamans can be male or female. Females are actually more feared by many Larhold, who superstitiously believe that their women are more devious and dangerous than males.

Beyond those leadership positions, status among the Larhold depends on one's courage and brutality, and on how much booty one has. A warrior's worth is measured in "mounts"; the traditional mount of the Larhold is the *War Bison*, a shaggy, supernatural horned creature that eats the flesh of other animals. Other mounts include horses and vehicles; a motorcycle counts as one mount, a truck or APC could count for as much as 3-6 mounts, and a tank or hover vehicle counts as 10-12 mounts. So, for example, a wealthy warrior who owned 6 Bronze bulls, two motorcycles and a truck would be said to have 11 mounts (the truck counting as three). Poor warriors who have only one mount often become the retainers of wealthier ones. The richest and more powerful warriors may have hundreds of retainers; eventually, these minor warlords split off to form their own tribe, or try to take over their original tribe.

Property only counts for so much. Combat abilities are greatly admired, even among enemies. Enemy warriors are often given the chance to die in combat by freeing them and letting them face Larhold warriors in single combat. Cruelty is also respected. A Larhold who displays new and inventive ways to torture prisoners, or who commits gruesome acts of murder, soon gains a positive reputation among the bloodthirsty warriors. Most tribes also practice ritual sacrifice and even cannibalism, especially if the victim is a powerful warrior; many Larhold believe that eating a warrior's heart will impart some of his courage on the partaker.



Larhold Barbarian R.C.C.

The Larhold are humanoid creatures. At first sight, they appear squat and short, but they stand six feet (1.8 m) tall on average. They have wide shoulders and are bow-legged as a result of a lifetime spent riding and shooting the bow. Four small, bison-like horns protrude from their temples, two on each side. Males usually grow long mustaches and goatees; both men and women braid their hair. The traditional dress consists of leather or suede pants and jackets, fur hats, and pointy-toed boots. Some warriors wear chain mail, plate and scale mail armor, but the traditional armor is the hide of their War Bisons, cured into M.D.C. leather breastplates, helmets and shields. Their traditional weapons are bows made with the supernaturally-tough sinews and bones of their bronze bulls, bows that not even cyborgs can bend, and whose arrows can penetrate the armor plating of power armor. Wealthier warriors use captured energy weapons, ultra-tech armor, and other weapons.

Although the Larhold are supernatural beings with great strength and endurance, the danger they pose lies in their tactics and savagery. The “barbarians” are master ambushers and experts in hit and run tactics. When faced with determined resistance, the nomads melt away, only to appear from another side to take their enemies by surprise. Nighttime raids, false retreats

and dirty tricks are all common among them. Another favored tactic, especially during sieges, is to use captured slaves as living shields, often friends and relatives of the besieged enemies, forcing them to choose between killing those loved ones or losing the battle. When they are certain of their victory, the Larhold will try to capture their enemies alive, to either enslave them, use them for sacrifices, or to torture them for the entertainment of the tribe. Often, hapless prisoners are released — after having been blinded or crippled in some gruesome way.

The Larhold are violent and cruel even against each other. The one exception are children; although Larhold discipline is harsh, the barbarians cherish their children, and mistreatment or abuse of their young is punishable by death, even if the abuser is the child’s parent. The children of enemies are fair targets, although the Larhold prefer to adopt young children into their ranks and teach them their ways. This is why renegades from hundreds of other races ride alongside the Larhold (see the **Larhold Renegade O.C.C.**, below).

Different Larhold tribes often war against each other, especially if one is entering the range claimed by another. Those inter-tribal conflicts are as savage as anything the Larhold are involved in; the barbarians often save their worst cruelties for each other; after all, who can best appreciate sadism than another Larhold? Sometimes, however, two or more tribes, or war bands from different tribes, will join forces for a while, usually when facing a strong common enemy. These alliances only last as long as it is convenient for both sides, which is rarely a long time.

Alignment: Any, but lean towards anarchist and evil.
M.D.C.: P.E. plus 2D4×10 M.D.C.
Attributes: I.Q. 3D6, M.E. 3D6, M.A. 3D6, P.S. 4D6+12, P.P. 3D6+2, P.E. 3D6+6, P.B. 2D4, Spd. 3D4
Size: Average 6 feet tall (1.8 m).
Weight: 200-350 lbs. (90 to 157.5 kg)
Horror Factor: 8, 10 if the Larhold's reputation is known.
P.P.E.: 3D6
Average Life Span: 70 years
Natural Abilities: Nightvision 200 feet (61.0 m), rapid healing (3D6 M.D.C. per hour of rest).
Experience Level: Varies. Average 1D4+2
Combat: As per skill. See bonuses, below.
Damage: Supernatural strength (see *Rifts Conversion Book One*, page 22).
Bonuses: Add one attack per melee, +1 on initiative, +2 to roll with impact, +2 to pull punch, +2 save vs magic, +6 to save vs horror factor. All these are in addition to skill and attribute bonuses.
Magic Powers: None unless a magical O.C.C. (see below) is selected.
Psonic Powers: Standard; same as humans.
Vulnerabilities/Penalties: None.
O.C.C.s: In addition to the basic Larhold Barbarian R.C.C., some Larhold learn different skills, especially in the field of magic. Possible O.C.C.s include Larhold shaman (see below), ley line walker, mystic, shifter, warlock, witch, and temporal mage. A few Larhold also have powerful psonics (use the Mind Melter and Burster R.C.C.s). In addition to the specific O.C.C. skills, all Larhold will have Riding: War Bison (same basic level as Horsemanship at +10%), and W.P.: Archery and Targeting.

R.C.C. Skills:

Language: Larhold (98%)
 Language: One of choice (+15%)
 Basic Math (+10%)
 Riding: War Bison (+20%)
 Wilderness Survival (+15%)
 Detect Ambush (+10%)
 Detect Concealment (+10%)
 W.P.: Archery and Targeting
 W.P. Sword
 W.P.: One of choice
 Hand to Hand: Expert
 Hand to Hand: Expert can be changed to Martial Arts or Assassin at the cost of one "other" skill.

R.C.C. Related Skills: Select seven "other" skills. Plus select two additional skills at level three and one at levels six, nine and twelve. All new skills start at level one proficiency.

Communications: Any
 Domestic: Any (+10%)
 Electrical: Basic Electronics only.
 Espionage: Any
 Mechanical: Automotive Mechanics only.
 Medical: Holistic Medicine only (+5%)
 Military: Any
 Physical: Any (+5% where applicable)
 Pilot: Any (+5%)
 Pilot Related: Any
 Rogue: Any (+5%)

Science: None
 Technical: Any (+10%)
 W.P.: Any
 Wilderness: Any (+10%)

Secondary Skills: The character also gets to select six secondary skills from the previous list. These are additional areas of knowledge that do not get the bonus listed in parentheses. Also, skills are limited as previously indicated in the list.

Alliances and Allies: Larhold tribesmen rely on each other, and occasionally on other tribes (when participating in a large-scale raid, for example), but have few other allies. Very rarely will the Larhold form an alliance or hire out their services to an alien intelligence, god of darkness or powerful warlord. Priests of the gods of Darkness will sometimes aid the Larhold if doing so benefits their cause.

Weapons: Larhold Composite Bow: does hand to hand damage (based on supernatural P.S.) +6 M.D., and has a range of 800 feet (244 m). The bow can only be wielded by beings with a supernatural strength of 16 or higher. Larhold Saber: an M.D. alloy that inflicts 2D6 M.D. in addition to the wielder's supernatural P.S. damage. Additionally, select one energy weapon of choice and 1D4 energy clips, and one modern weapon.

Body Armor: Traditional Larhold Hide Armor: 70 M.D.C., good mobility (-10% to prowl rolls). May wear captured armor.

Other Equipment: A war bison mount (see below), or a small vehicle (typically a motorcycle), camping kit, dry rations for 1 week, cooking utensils, and 1D6×1000 credits in cash or trade items.



Larhold Human Renegade O.C.C.

Not all the members of the Larhold tribes belong to that race of beings. Members of other races, the children and great-grandchildren of slaves and other victims, have sometimes managed to rise to a state of near-equality with their former captors. These "new Larhold" are typically more violent, savage and blood-thirsty than the norm; they have to be to gain acceptance. Their lives are brutal and short; very few human barbarians live past the age of thirty. Furthermore, their years of being exposed to transdimensional creatures have partially transformed them; al-

though they are still normal flesh and blood, their P.P.E. reserves are very high, and they can channel that energy to temporarily increase their strength and endurance to superhuman levels.

A few of these human barbarians turn against their former companions and abandon the tribes. Out in the world, they risk being attacked by those who have good reason to distrust and hate the Larhold. Some have survived and even thrived, however. A renegade became an important general of New Babylon's House of War, and won much glory fighting the same tribes he abandoned.

O.C.C. Abilities and Bonuses:

1. Physical Bonuses: Human renegades are hardened by their brutal lives, gaining +2D6×10 S.D.C., +3 to P.S. and P.E., and +2 to P.P., in addition to skill bonuses.

2. P.P.E.: Their contact with supernatural creatures and their semi-mystical upbringing greatly raises the level of P.P.E. among these barbarians. Base P.P.E. is 6D6 plus the P.E. attribute; add 1D6 P.P.E. per additional level of experience.

3. Temporary Superhuman Transformation: By spending P.P.E., the character can temporarily "super-charge" himself, becoming the match of a full-blooded Larhold for a brief time. The transformation costs 25 P.P.E. and lasts three minutes per level of experience. During that time, the character inflicts 1D4 M.D. plus his P.S. bonus with his bare hands (if using a Larhold sword, vibro-blade or similar M.D. weapon, this M.D. damage is added to the weapon's). Additionally, his S.D.C. (but not hit points) are temporarily transformed into M.D.C. points! At the end of the transformation, any damage sustained carries over as S.D.C. points on a one-to-one basis; if the temporary M.D.C. is reduced to zero, the character dies!

Larhold Human Renegade O.C.C.

Attribute Requirements: The minimum P.S., P.E. and P.P. of these renegades is 14.

O.C.C. Skills:

Language: Larhold (98%)

Language: One of choice (+15%)

Basic Math (+10%)

Riding: War Bison (+15%)

Wilderness Survival (+12%)

Detect Ambush (+8%)

Detect Concealment (+10%)

W.P.: Archery and Targeting

W.P. Sword

W.P.: One of choice

Hand to Hand: Expert

Hand to Hand: Expert can be changed to martial arts or assassin at the cost of one "other" skill.

O.C.C. Related Skills: Select seven "other" skills. Plus select two additional skills at level three and one at levels six, nine and twelve. All new skills start at level one proficiency.

Communications: Any (+5%)

Domestic: Any (+10%)

Electrical: Basic Electronics only.

Espionage: Any

Mechanical: Automotive Mechanics only.

Medical: Holistic Medicine only (+5%)

Military: Any

Physical: Any (+5% where applicable)

Pilot: Any (+5%)

Pilot Related: Any

Rogue: Any (+6)

Science: None

Technical: Any (+10%)

W.P.: Any

Wilderness: Any (+10%)

Secondary Skills: The character also gets to select two secondary skills from the previous list at levels one, three, seven and eleven. These are additional areas of knowledge that do not get the bonus listed in parentheses. Also, skills are limited as previously indicated in the list.

Standard Equipment: Composite bow (Cannot use the Larhold bow) and 24 explosive arrows.

Larhold saber: an M.D. alloy that inflicts 1D4 M.D. if wielded by a being without supernatural strength, or 2D6 M.D. in addition to the wearer's supernatural P.S. damage when wielded by a supernatural being. This means when "charged up," the renegades inflict the higher damage with this weapon. Additionally, select one energy weapon of choice and 1D4 energy clips, and one modern weapon.

Body Armor: Traditional Larhold Hide Armor: 70 M.D.C., good mobility (-10% to prowl rolls). May wear captured armor.

Other Equipment: A war bison mount, or a small vehicle (typically a motorcycle), camping kit, dry rations for 1 week, cooking utensils, and 1D6×1000 credits in cash or trade items.

Money: 2D6×100 in credit and 1D4×1000 in trade items.

Cybernetics: Starts with none.

War Bison

At first sight, these creatures appear to be large bison or buffalo, unusual only because of the four horns on their heads. When angered or hungry, however, these creatures bare their teeth, revealing huge canines. Their eyes also shine with intelligence and malevolence one would never expect from a herbivore.

The war bisons are strange creatures of unknown origins. Their basic body shape appears unsuitable for a predator; they are hoofed, heavy animals, and their horns are too small to be very effective weapons. For some reason, however, the war bison eat flesh and hunt live prey. Maybe they are a magical creation, or the result of an experiment by the Gene-Splicers. In any case, their brutality and savagery is just as great as their master's.

Alignment: Considered to be diabolic or aberrant.

M.D.C.: 1D4×100+100

Attributes: I.Q. 2D4+3 (high animal intelligence), M.E. 2D6, M.A. 2D4, P.S. 2D6+30. P.P. 1D6+18, P.E. 2D6+14, P.B. 1D4, Spd. 2D4×10+80

Horror Factor: 9, 13 if the Larhold are a known menace.

P.P.E.: 3D6+8

Natural Abilities: Nightvision 600 feet (183 m), regeneration 1D4×10 M.D. per minute.

Combat: Four attacks per melee.

Bonuses: +1 on initiative, +2 to strike, +1 to parry (with horns) and dodge, +4 to save vs magic and disease. In addition to attribute bonuses.

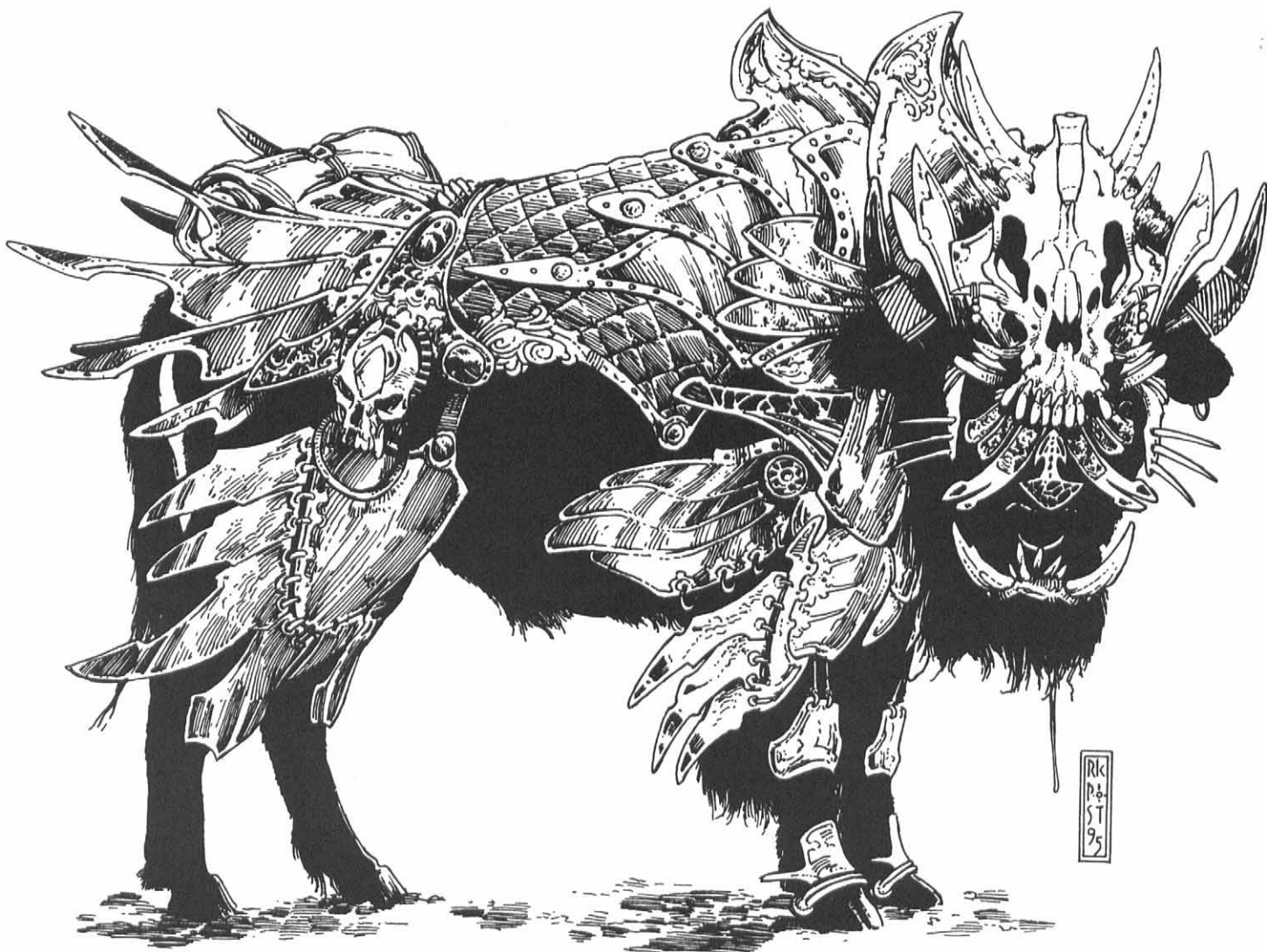

Damage: Bite: 4D6 M.D. Head Butt: 5D6 M.D. if standing still, 1D4×10 M.D. with a running start. Power butt does 1D6×10+10 M.D. (counts as two melee attacks).

Magic: None.

Psionics: None.

Average Life Span: 70 years.

Languages: Understand (but cannot speak) Larhold (65%).

Value: The Larhold measure their value in War Bison; for ex-

ample, a tank might be worth ten or twelve war bison. This translates to roughly 50,000 to 100,000 credits, although the creatures are not for sale.

Habitat: Typically plains and woodlands.

Enemies: All enemies of the Larhold.

Size: 5-7 feet (1.5 to 2.1 m) at the shoulder (head adds another 1-3 feet), and 7 to 10 feet (2.1 to 3.0 m) long.

Weight: 1,000 to 4,000 lb. (450 to 1800 kg)

Larhold

Shaman O.C.C.

The early Larhold primitives dwelt on a green-skied world that often crackled with blue flame. The Blue Flame is some sort of elemental force of great power that is all but unknown to most other races of the Megaverse. The early Larhold wise men and women learned to tame its power, either by mystically linking to it, or by learning spells and rituals that accessed it. The former type became shamans, primitive priests of this mindless but powerful elemental force. The others are magicians (use the ley line walker O.C.C.) who discovered spells that can be taught to anybody with the talent to work magic. The shamans can use the Blue Flame more effectively than anyone else, however.

True shamans (the term shaman is also used by the Larhold to refer to ley line walkers, witches, warlocks and other practitioners of magic) are mysterious, often feared figures. Most of them hide their features with bizarre masks with demonic designs. They also wrap themselves with bandages and cloaks. In many cases, this is to mask their hideously burned bodies: many of the mystical rituals the shamans perform involve giving oneself to the blue flame, resulting in painful, disfiguring scars. But the masks and wrappings are also used as symbols of fear and power. Few Larhold will question what one of the demon-masked shamans do (a few adventurers have disguised themselves as shamans and managed to fool the unwary; however, another shaman will instantly discover the masquerade, with terrible consequences).

The shamans use their magic, especially magic related to the blue flame, to harm the enemy, heal the wounded and sick, and aid warriors in combat. They often get the extra P.P.E. they need to fuel spells by sacrificing helpless victims. Shamans are often among the most skilled torturers among the Larhold, using their magic to inflict unimaginable pain. These last two characteristics have made shamans the most hated Larhold in the Megaverse. Enemies of the barbarians will rarely show them any mercy or give them any quarter. The magic users know this, so most will fight to the death if they cannot escape their tormentors. A cornered shaman is at his most dangerous, for unless he is taken down quickly he will use his last breath to call down the Blue Flame to consume him and his enemies in a huge explosion!

Other practitioners of magic often mimic the dress and mannerisms of shamans, the better to impress their fellow Larhold, but are forbidden from wearing the demon-masks of the true shaman. Any non-shaman caught wearing those sacred badges of offices are condemned to a horrible, lengthy execution. The only rivals of the shamans are the priests of the gods of darkness.

Not all Larhold shaman are evil or serve their barbarian tribe. A few renegades live and practice their magic away from the evil nomads. The Blue Flame is not inherently evil; like many elemental forces, it is above such concerns. Also, shamans can belong to other races besides the Larhold. Humans, ogres, wolven and others have sometimes been trained in the *Ways of the Flame*. However, all shaman, good or evil, are in danger of being killed by the many people of South America, due to the reputation their kind has earned.

Shaman O.C.C. Abilities and Bonuses:

1. Connection to the Blue Flame: The mystic connection to this elemental force allows "True" Larhold shamans to sense the use of any spell or ritual related to the blue flame. **Range:** One mile (1.6 km) per level of experience. The shaman will not know what the spell is, or for what purpose, but he will know the general distance and direction where the flame magic was summoned.

2. Initial Spell Knowledge: At first level, select a total of three Blue Flame spells (from any level) and five common spells from levels one and two. These are part of the shaman's permanent spell casting capabilities. Once selected, they cannot be changed.

3. Learning New Spells: Like a mystic, the shaman will intuitively sense when he or she has reached a new metaphysical plateau (level of experience). A ritual of immersion into the Blue Flame must be performed, taking 2 hours. During the ritual, there is a 15% chance that the shaman will be burned by the Blue Flame, scarring him for life (reduce P.B. by 1). At the end of the ritual, the character has learned new spells.

At level two, an additional four spells from levels one, two and three (or any Blue Flame spells) can be learned. At third level and beyond, the shaman can mystically acquire two more spells from any of the levels, up to his own level of experience (i.e., levels 1-3 at level three, 1-4 at level four, etc.). Shamans cannot learn or purchase spells.

4. P.P.E.: Shamans are living batteries of mystic energy; their connection with the Blue Flame greatly increases their power. Base P.P.E.: 3D6×10 plus P.E. attribute. Add 3D6 P.P.E. per each additional level of experience.

5. Summon Blue Light: The shaman can always rely on the Blue Flame to illuminate an area. By spending 1 P.P.E., the shaman can light up an area of 30 feet (9.1 m) for one hour. Illuminating a larger area requires the actual use of spells.

6. Ritual of Immolation: All shamans learn this lethal ritual during their apprenticeship, as a way to get revenge on one's enemies even at the time of death. Shamans who wish to die and take their enemies with them start the ritual, which lasts for 30 seconds (two melee rounds). As the ritual occurs, the shaman is surrounded by a nimbus of blue flame, which inflicts 2D6 M.D. to anyone touching it. The ritual is purely mental; restraining or attacking the shaman does not stop it; only killing him will prevent the completion of the ritual. When the ritual starts, any spell or power affecting the shaman (both positive and negative) will be automatically negated! If somebody doesn't kill the shaman or knock him unconscious, or into a coma, at the end of the ritual he will explode into flames! The explosion will cover a 100 foot (30.5 m) radius, plus 10 feet (3.0 m) per level of experience. Everyone in the area will take 2D4×10 M.D. per level of the shaman (4D4×10 M.D. from a second level shaman, 1D4×100 M.D. from a 5th level shaman, etc). Even characters protected by the invulnerable to energy spell will suffer half damage.

The ritual is always fatal. Even if the shaman decides to stop it, or is knocked unconscious, he will die within 1D4 minutes. No force beyond the resurrection powers of the gods can restore the priest back to life (even deities have a -30% penalty to successfully resurrect the victim); the shaman has been claimed by the Blue Flame, which will not relinquish him.



7. Supernatural Bonuses: +10 to M.D.C. for Larhold and other supernatural (M.D.C.) creatures; humans and other S.D.C. creatures who are initiated into the Ways of the Flame become minor M.D.C. creatures; M.D.C. is equal to P.E. plus 1D4 per level of experience.

8. Other Bonuses: +3 to save versus horror factor, +1 to spell strength at levels four, seven, ten and thirteen.

Larhold Shaman O.C.C.

Alignment: Most are anarchist or evil; those who use human sacrifices to power their magic are always evil. Only a few renegades are good or unprincipled.

Attribute Requirements: M.E. 10 or higher.

O.C.C. Skills:

Language: Larhold (98%)

Language of choice (+25%)

Basic and Advanced Math (+25%)

Demon and Monster Lore (+15%)

Riding: War Bison (+10%)

Holistic Medicine (+10%)

Wilderness Survival (+5%)

W.P.: Archery and Targeting

W.P.: Sword

Hand to Hand: Basic

Hand to Hand: Basic can be converted to hand to hand: expert at the cost of one "other" skill, or to martial arts or assassin at the cost of two other skills

O.C.C. Related Skills: Select six other skills. Plus select one additional skill at levels three, five, eight, twelve and fourteen.

All new skills start at the base skill level.

Communications: Any

Domestic: Any (+10%)

Electrical: None.

Espionage: Any

Mechanical: None.

Medical: Any

Military: None.

Physical: Any

Pilot: Any

Pilot Related: Any

Rogue: Any

Science: Any (+5%)

Technical: Any (+10%)

W.P.: Any

Wilderness: Any

Secondary Skills: The character also gets to select three secondary skills at levels one, four and nine. These are additional areas of knowledge that do not get the bonuses listed in parentheses. Also, skills are limited (any, only, none) as previously indicated in the list.

Standard Equipment: Demon-Mask and Shaman Robes; these symbols of office have a Horror Factor of 7 against Larhold or people who know and fear Larhold shamans. Animal hide or light body armor can be worn under the vestments. Traditional Larhold Hide Armor: 70 M.D.C., good mobility (-10% to prowling rolls). May wear captured armor.

Larhold Composite Bow: does hand to hand damage (based on supernatural P.S.) +3 M.D., and has a range of 800 feet (244 m). The bow can only be wielded by beings with a *supernatural* strength of 18 or higher (or robot P.S. of 30+).

Larhold Saber: an M.D. alloy that inflicts 2D6 M.D. in addition to the wearer's supernatural P.S. damage.

Additionally, select one energy weapon of choice and 1D4 energy clips, and one modern weapon.

A war bison mount (see above), or a small vehicle (typically a motorcycle or robot horse), camping kit, dry rations for two weeks, cooking utensils, and holistic medicine bag.

At third level, Larhold Shamans are granted a magic weapon by their tribe. They must still be members in good standing of the tribe to receive the gift, which is granted during a major ceremony.

Money: 2D6×1000 credits in cash or trade items.

Cybernetics: None. Cybernetics affect magic and are avoided at all costs.

Blue Flame Spells

These spells can be learned by any magician, but they need to be aware of the Blue Flame and must learn the spells from the Larhold or those who have learned it from the Larhold. The blue flame is an elemental force that has no apparent alignment or intrinsic intelligence. The equivalent level of the spell is listed below:

Alphabetical List of Blue Flame Spells

Burning Light of the Blue Flame (12 P.P.E.)

Eyes of Blue Flame (6 P.P.E.)

Fists of Blue Flame (10 P.P.E.)

Flamebolts (20 P.P.E.)

Flamehalo (15 P.P.E.)

Flameshield (30 P.P.E.)

Flamewings (15 P.P.E.)

Healing Flame (60 P.P.E.)

Sense Blue Flame (2 P.P.E.)

Whip of Agony (20 P.P.E.)

Burning Light of Blue Flame (Level 6)

Range: 100 feet (30.5 m) +50 feet (15.2 m) per level of experience.

Duration: One melee round per level of experience.

Saving Throw: Dodge only (16 or higher)

P.P.E.: 12

This spell creates a tiny pillar of blue flame in the hand of the spell caster. At will (equal to the character's number of attacks per melee), a bright beam of blue light erupts from the flame and toward any target in the spell caster's line of sight. The light burns with the intensity of a high-powered laser, inflicting 1D6 M.D. or S.D.C. (spell caster's choice) per every two levels of experience. Vampires suffer triple damage and cannot come within 50 feet (15.2 m) of the flame.

Eyes of Blue Flame (Level 3)

Range: Self

Duration: One minute per level of experience.

Saving Throw: Not applicable

P.P.E.: 6

The spell caster's eyes appear to be made of fire. The character can see all spectrums of light and heat, and therefore, virtu-

ally all invisible beings, including invisible elementals. Furthermore, he is impervious to heat and all S.D.C. flames, can see in total darkness 400 feet (122 m), and is +3 to save vs illusions.



Fist of Blue Flame (Level 4)

Range: Self.

Duration: One minute per level of experience.

Saving Throw: Dodge only (16 or higher)

P.P.E.: 10

The spell caster's fist seems to be enveloped in a ball of Blue Flame that does not burn his flesh, but inflicts 2D6 M.D. plus the character's normal P.S. damage with every punch or slap.

Flamebolts (Level 6)

Range: 200 feet (61.0 m) plus 30 feet (9 m) per level of experience.

Duration: Instant

Saving Throw: Dodge only (16 or higher)

P.P.E.: 20

Fires a bolt of blue flame that twists and turns while trying to hit the target. The only possible defense against this attack is to dodge, and even then the target must roll a 16 or higher. Damage is 3D6 M.D. plus 1D6 at levels three, five, seven, nine, eleven, thirteen and fifteen. Creatures vulnerable to flame suffer double damage.

Flamehalo (Level 5)

Range: Self

Duration: Two minutes per level of experience.

Saving Throw: Not applicable.

P.P.E.: 15

A halo of blue flame flickers around the spell caster, making him impervious to psionic probes (including see aura), disease and possession. Furthermore, the character is +1 to save vs psionics.

Flameshield (Level 7)

Range: Self

Duration: 1 minute (4 melees) per level of the caster.

Saving Throw: None

P.P.E.: 30

Creates an aura of semi-transparent blue flames that protects the spell caster with 100 M.D.C. plus 10 per additional level of the caster like a force field. While the flameshield is on, flame and energy attacks do one-quarter damage, and the person is im-

mune to heat, cold, non-M.D.C. fire and similar environmental hazards. The protection ends when the spell's duration elapses or the M.D.C. of the shield is depleted.

Flamewings (Level 7)

Range: Self or other by touch.

Duration: Two minutes per level of the spell caster.

Saving Throw: None.

P.P.E.: 25

The character with flamewings can fly through the air, silently, like the wind. Maximum speed is 100 mph (160 kmph).

Healing Flame (Level 8)

Range: Touch

Duration: Permanent

Saving Throw: None.

P.P.E.: 60

Can heal any wound and restores 1D6 hit points, S.D.C. or M.D.C. per level of the spell caster. It can also help people in a coma; +15% +2% per level of the spell caster. It can even bring back the recently dead (costs twice as much P.P.E.)! The chance is only 20%, +2% per level of the caster, -5% per day since the time of death. When used to save a person in a coma, or to restore the dead back to life, the flame will scar the patient, reducing his or her P.B. by 25%.

Sense Blue Flame (Level One)

Range: 100 feet (30.5 m) plus 10 feet (3.0 m) per level of experience.

Duration: Instant

Saving Throw: None

P.P.E.: 2

Detects the presence of blue flame being used in the area. Magicians who know blue flame spells will only be revealed if they are currently using a blue flame spell.

Whip of Agony (Level 7)

Range: 20 feet (6.1 m) per level of experience.

Duration: 1 minute per level of experience.

Saving Throw: Parry or dodge.

P.P.E.: 20

This spell creates a crackling whip of Blue Flame. The whip can be used as a weapon, is +2 to strike in addition to any hand to hand or W.P. bonuses, and inflicts 1D6 M.D. per level of the caster. Alternatively, the whip can be used as a torture device (does 1 point of S.D.C. or M.D. damage, but racks the victim with unimaginable agony — must touch the skin of the victim to work). Survivors of such a torture have to save versus insanity (12 or higher); a failed roll means insanity (G.M. assign a phobia about shaman, Larhold, whips, torture, blue flame, fire in general or roll for a random insanity).



Experience Point Tables

True Inca

1 0,000-2,400
 2 2,401-4,600
 3 4,601-9,200
 4 9,201-18,400
 5 18,401-28,300
 6 28,301-48,000
 7 48,001-78,000
 8 78,001-110,000
 9 110,001-150,000
 10 150,001-200,000
 11 200,001-250,000
 12 250,001-310,000
 13 310,001-380,000
 14 380,001-470,000
 15 470,001-600,000

Arkhon,

Amaki Stone Man

1 0,000-2,120
 2 2,121-4,280
 3 4,281-8,480
 4 8,481-16,960
 5 16,961-24,960
 6 24,961-34,960
 7 34,961-49,960
 8 49,961-69,960
 9 69,961-94,960
 10 94,961-129,960
 11 129,961-179,960
 12 179,961-229,960
 13 229,961-279,960
 14 279,961-329,960
 15 329,961-389,960

Fallam,

Ojahee,

Pucara Red Giant

1 0,000-2,200
 2 2,201-4,400
 3 4,401-8,900
 4 8,901-18,000
 5 18,001-26,000
 6 26,001-36,000
 7 36,001-52,000
 8 52,001-76,000
 9 76,001-100,000
 10 100,001-150,000
 11 150,001-200,000
 12 200,001-275,000
 13 275,001-350,000
 14 350,001-425,000
 15 425,001-525,000

Gaucha

1 0,000-1,900
 2 1,901-3,800
 3 3,801-7,300
 4 7,301-14,300
 5 14,301-21,000
 6 21,001-30,000
 7 30,001-40,000
 8 40,001-53,000
 9 53,001-73,000
 10 73,001-103,000
 11 103,001-138,000
 12 138,001-188,000
 13 188,001-238,000
 14 238,001-288,000
 15 288,001-328,000

Men-Rall "Techmaster",

Nazcan Line Maker

1 0,000-2,240
 2 2,241-4,480
 3 4,481-8,960
 4 8,961-17,920
 5 17,921-25,920
 6 25,921-35,920
 7 35,921-50,920
 8 50,921-70,920
 9 70,921-95,920
 10 95,921-135,920
 11 135,921-185,920
 12 185,921-225,920
 13 225,921-275,920
 14 275,921-335,920
 15 335,921-395,920

Duelist,

Fallam Battlemaster,

Rune Warrior

1 0,000-2,300
 2 2,301-4,500
 3 4,501-10,000
 4 10,001-20,000
 5 20,001-30,000
 6 30,001-42,000
 7 42,001-65,000
 8 65,001-85,000
 9 85,001-110,000
 10 110,001-160,000
 11 160,001-210,000
 12 210,001-285,000
 13 285,001-370,000
 14 370,001-450,000
 15 450,001-575,000

Ancient - Inca Undead

1 0,000-5,000
 2 5,001-10,000
 3 10,001-20,000
 4 20,001-40,000
 5 40,001-80,000
 6 80,001-120,000
 7 120,001-160,000
 8 160,001-200,000
 9 200,001-250,000
 10 250,001-300,000
 11 300,001-400,000
 12 400,001-500,000
 13 500,001-600,000
 14 600,001-1 Million
 15 1 Million-2 Million

Larhold Human Renegade,

Plains 'Borg, ESP Specialist

Megaversal Trooper

1 0,000-2,100
 2 2,101-4,200
 3 4,201-8,400
 4 8,401-17,200
 5 17,201-25,400
 6 25,401-35,800
 7 35,801-51,000
 8 51,001-71,200
 9 71,201-96,400
 10 96,401-131,600
 11 131,601-181,800
 12 181,801-232,000
 13 232,001-282,200
 14 282,201-342,400
 15 342,401-402,400

Ojahee 'Borg,

Ultra-Crazy,

Arkhon Spectral Hunter

1 0,000-2,650
 2 2,651-5,300
 3 5,301-11,000
 4 11,001-21,000
 5 21,001-32,000
 6 32,001-42,000
 7 42,001-62,000
 8 62,001-90,000
 9 90,001-120,000
 10 120,001-170,000
 11 170,001-220,000
 12 220,001-290,000
 13 290,001-400,000
 14 400,001-500,000
 15 500,001-700,000

Larhold Shaman,

Pucara Mind Mage,

Sun Priest

1 0,000-2,050
 2 2,051-4,100
 3 4,101-8,250
 4 8,251-16,500
 5 16,501-24,600
 6 24,601-34,700
 7 34,701-49,800
 8 49,801-69,900
 9 69,901-95,000
 10 95,001-130,100
 11 130,101-180,200
 12 180,201-230,300
 13 230,301-280,400
 14 280,401-340,500
 15 340,501-400,600

Master Blood-Rider,

Achilles Serpentoid

1 0,000-2,250
 2 2,251-4,500
 3 4,501-9,000
 4 9,001-18,500
 5 18,501-27,500
 6 27,501-38,000
 7 38,001-54,000
 8 54,001-76,000
 9 76,001-100,000
 10 100,001-145,000
 11 145,001-190,000
 12 190,001-240,000
 13 240,001-300,000
 14 300,001-360,000
 15 360,001-420,000

Condoroid, Falconoid,

Achilles Mutant Capybara

1 0,000-2,400
 2 2,401-4,800
 3 4,801-8,800
 4 9,601-19,200
 5 19,201-29,000
 6 29,001-38,000
 7 38,001-55,000
 8 55,001-78,000
 9 78,001-99,000
 10 99,001-132,000
 11 132,001-182,000
 12 182,001-232,000
 13 232,001-282,000
 14 282,001-343,000
 15 343,001-403,000

Destroyer 'Borg,

Inca Warrior

1 0,000-2,150
 2 2,151-4,300
 3 4,301-8,600
 4 8,601-17,200
 5 17,201-25,500
 6 25,501-36,000
 7 36,001-52,000
 8 52,001-73,000
 9 73,001-98,000
 10 98,001-134,000
 11 134,001-184,000
 12 184,001-240,000
 13 240,001-295,000
 14 295,001-365,000
 15 365,001-425,000

Larhold Barbarian,

Neo-Human, Equinoid

1 0,000-2,600
 2 2,601-5,000
 3 5,001-10,000
 4 10,001-20,000
 5 20,001-30,000
 6 30,001-39,000
 7 39,001-52,000
 8 52,001-70,000
 9 70,001-100,000
 10 100,001-140,000
 11 140,001-190,000
 12 190,001-240,000
 13 240,001-290,000
 14 290,001-350,000
 15 350,001-520,000

Gizmoteer,

Blood Rider,

Blood Lizard

1 0,000-2,300
 2 2,301-4,600
 3 4,601-9,200
 4 9,201-18,400
 5 18,401-26,500
 6 26,501-36,600
 7 36,601-51,700
 8 51,701-71,800
 9 71,801-96,900
 10 96,901-137,000
 11 137,001-188,100
 12 188,101-229,200
 13 229,201-279,300
 14 279,301-340,400
 15 340,401-400,000

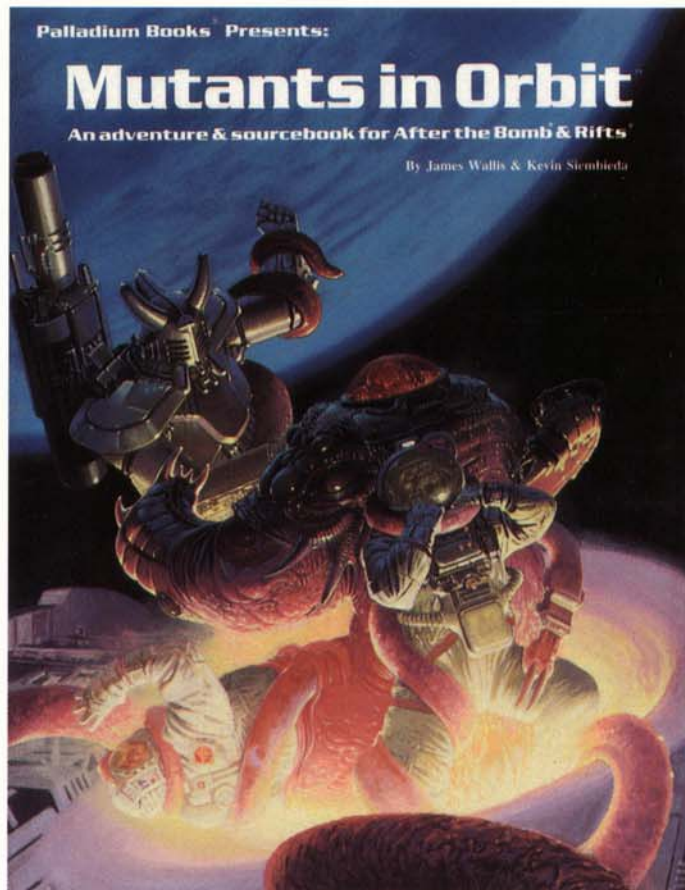

Also from Palladium Books®

Mutants in Orbit

Ever wonder if the pre-Rifts civilizations ever tried to colonize space?

They did, and this book reveals all their secrets! *Mutants in Orbit* is a sourcebook for both **Rifts®** and **After the Bomb®** with tons of great source-material and adventure ideas. Even the material written *After the Bomb* has cool ideas and is easy to adapt to **Rifts®** or **Heroes Unlimited™**.

- Space Stations, space ships, and killer satellites.
- Space Glitter Boys, the Steel Dragon, and other robots.
- Cyberworks and A.R.C.H.I.E. 7.
- Virtual Reality Robot Defense System and VRRDS junkies.
- CAN Republic, moon base and other nations.
- The Mars outpost; over-run with mutant insects.
- Mutant insect creation tables.
- World information and the date of the Great Cataclysm.
- Parkinson cover; interior art by Gustovich, Ewel & Long.
- Rifts® and mutant sections written by Kevin Siembieda.
- 112 pages — \$11.95; cat. no. 514

Available at hobby shops, book, and comic stores everywhere!

Palladium Books® Presents:

Rifts® South America 2

- Over 30 O.C.C.s and R.C.C.s including the Nazca Line Makers, Megaversal Legion, Blood Riders, Neo-Humans, Psi-Taurs, Red Giants, Warriors of the Sun, Larhold Barbarians, mutant animals, and demigods.
- Nazca line makers and line magic.
- The return of ancient gods and the Inca Empire.
- Lost of new power armor, robots, tanks, weapons and equipment.
- The Blood Weeper and Ancients; undead beings of pure evil.
- Arkhon Spectral Hunters, a special brand of cyborg with terrifying stealth and weapon systems.
- Arkhon aliens, their technology and weapons of war.
- More world information about South America and much more.
- Over 190 pages of epic adventure.

Explore the entire Palladium Books® Megaverse®!

\$19.95

Cat. No. 819

I.S.B.N. 0916211-89-4

ISBN 0-916211-89-4



9 780916 211899